

BELL 412/412EP

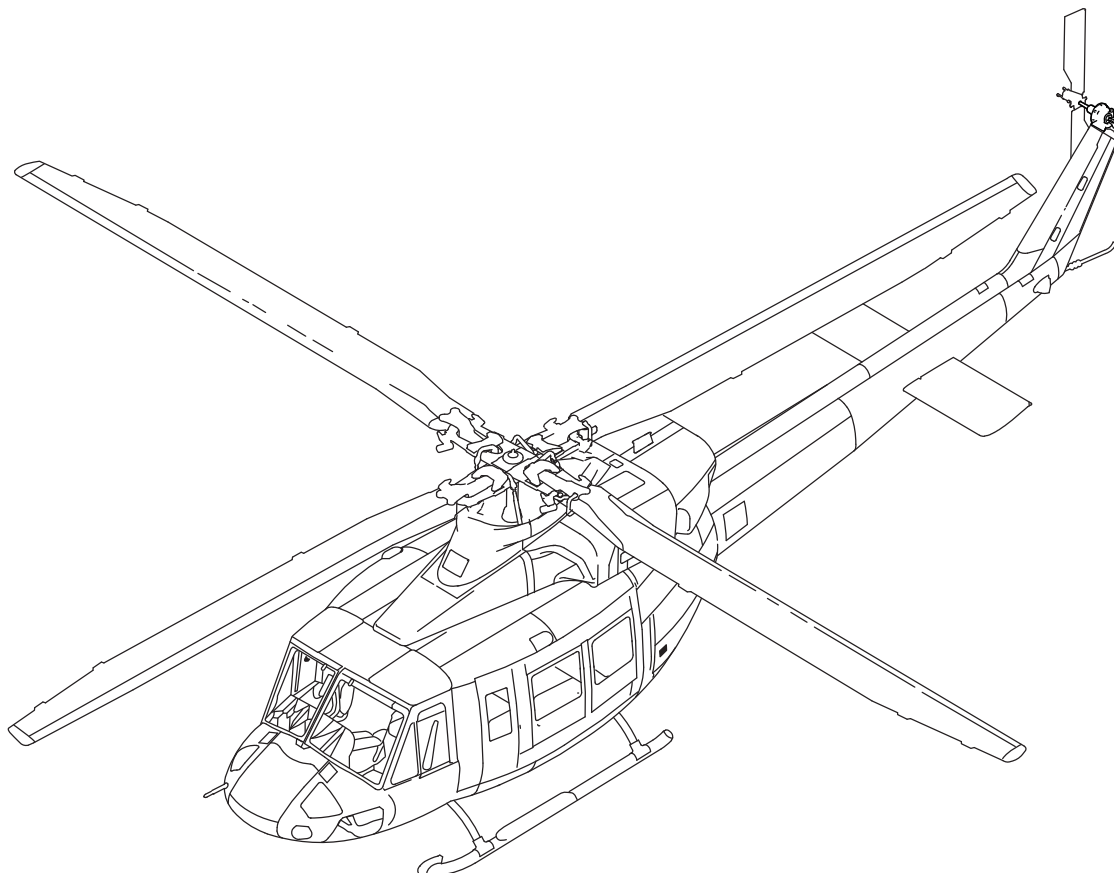

MAINTENANCE MANUAL VOLUME 1 GENERAL INFORMATION

NOTICE

The instructions set forth in this manual, as supplemented or modified by Alert Service Bulletins (ASB) or other directions issued by Bell Textron Inc. and Airworthiness Directives (AD) issued by the applicable regulatory agencies, shall be strictly followed.

COPYRIGHT NOTICE
COPYRIGHT 2022
BELL TEXTRON INC. AND
BELL TEXTRON CANADA LIMITED.

ALL RIGHTS RESERVED



POST OFFICE BOX 482 • FORT WORTH, TEXAS 76101

**REISSUE — 23 JUNE 1994
REVISION 32 — 04 MARCH 2022**



PROPRIETARY RIGHTS NOTICE

These data are proprietary to Bell Textron Inc. Disclosure, reproduction, or use of these data for any purpose other than helicopter operation or maintenance is forbidden without prior written authorization from Bell Textron Inc.

DESTINATION CONTROL STATEMENT

WARNING — This document contains technical data whose export is restricted by the Arms Export Control Act (Title 22, U.S.C., Sec 2751, et. seq.) or the Export Administration Act of 1979, as amended, Title 50, U.S.C., App. 2401 et. seq. Violations of these export laws are subject to severe criminal penalties. Disseminate in accordance with provisions of DoD Directive 5230.25.



WARNING

THIS MANUAL APPLIES ONLY TO HELICOPTERS AND COMPONENTS MAINTAINED IN ACCORDANCE WITH BELL TEXTRON INC. APPROVED PROCEDURES USING BELL APPROVED PARTS.

ALL INSPECTION, REPAIR AND OVERHAUL PROCEDURES PUBLISHED BY BELL, INCLUDING PART RETIREMENT LIFE, ARE BASED SOLELY ON THE USE OF BELL PARTS THAT HAVE BEEN MAINTAINED USING BELL APPROVED DATA. THE DATA PUBLISHED HEREIN OR OTHERWISE SUPPLIED BY BELL IS NOT APPLICABLE TO NON-BELL PARTS OR PARTS THAT HAVE BEEN REPAIRED USING DATA AND/OR PROCESSES NOT APPROVED BY BELL.

BELL IS NOT RESPONSIBLE FOR ANY PART OTHER THAN THOSE THAT IT HAS APPROVED.

BEFORE PERFORMING ANY PROCEDURE CONTAINED IN THIS MANUAL YOU MUST INSPECT THE AFFECTED PARTS AND RECORDS FOR EVIDENCE OF ANY MANUFACTURE, REPAIR, REWORK OR USE OF A PROCESS NOT APPROVED BY BELL.

IF YOU IDENTIFY OR SUSPECT THE USE OF PARTS NOT AUTHORIZED BY BELL, EITHER REMOVE THE AFFECTED ITEM FROM THE AIRCRAFT OR OBTAIN INSTRUCTIONS FOR CONTINUED AIRWORTHINESS FROM THE MANUFACTURER OR THE ORGANIZATION THAT APPROVED THE REPAIR.



CUSTOMER SUPPORT AND SERVICES

Flying smart means that no matter where you are, or what time it is, you can make a call and get additional information, clarification, or advice on a technical or operational issue concerning your helicopter or information contained in our Technical Publications. Product Support Engineering (PSE) is just a phone call away and may be contacted as follows:

Model 206, 407, or 505

Phone: 450-437-2862 or 800-363-8023 (U.S./Canada)

Fax: 450-433-0272

E-mail: pselight@bellflight.com**Model 222, 230, 427, 429, or 430**

Phone: 450-437-2077 or 800-463-3036 (U.S./Canada)

Fax: 450-433-0272

E-mail: pseinter@bellflight.com**Model 204, 205, 212, or 412**

Phone: 450-437-6201 or 800-363-8028 (U.S./Canada)

Fax: 450-433-0272

E-mail: psemedium@bellflight.com**Model 210, HUEY II and All Bell's Active and Surplus
Military Medium Helicopter Models**

Phone: 817-280-3548

Fax: 817-280-2635

E-mail: mts-medium@bellflight.com**Model OH-58, TH-67, TH-57, Both Active and Surplus
Military**

Phone: 817-280-3548

Fax: 817-280-2635

E-mail: mts-light@bellflight.com

For additional information on Customer Support and Services as well as Product Support Engineering (PSE) and your local Customer Service Engineering (CSE) network, please access <https://www.bellflight.com/support>.



LOG OF REVISIONS

Insert latest revision pages and dispose of superseded ones.

On a revised page, the text and/or illustration affected by the latest revision is shown by a vertical line. A revised page with only a vertical line next to the page number indicates that text has shifted or that non-technical correction(s) were made on that page.

Original 0 15 JAN 81	Revision 1 20 FEB 91	Revision 15 01 MAY 12
Revision 1 15 MAY 81	Revision 2 06 DEC 91	Revision 16 26 FEB 13
Revision 2 15 NOV 81	Revision 3 28 FEB 92	Revision 17 26 MAR 13
Revision 3 24 FEB 82	Reissue 0 07 JUN 93	Revision 18 30 JUN 13
Revision 4 09 NOV 82	Revision 1 08 DEC 93	Revision 19 30 AUG 13
Revision 5 09 DEC 82	Reissue 0 23 JUN 94	Revision 20 02 SEP 14
Revision 6 15 JAN 83	Revision 1 12 APR 95	Revision 21 30 JAN 15
Revision 7 31 MAR 83	Revision 2 10 JUL 95	Revision 22 24 JUL 15
Revision 8 01 MAY 83	Revision 3 15 APR 96	Revision 23 15 DEC 15
Revision 9 29 JUN 83	Revision 4 04 OCT 96	Revision 24 15 SEP 16
Revision 10 20 OCT 83	Revision 5 16 FEB 01	Revision 25 07 NOV 16
Revision 11 10 JAN 84	Revision 6 01 OCT 02	Revision 26 01 JUN 18
Revision 12 16 MAR 84	Revision 7 30 SEP 03	Revision 27 25 SEP 18
Revision 13 15 APR 84	Revision 8 18 JUN 04	Revision 28 13 DEC 19
Revision 14 30 JUL 84	Revision 9 13 AUG 04	Revision 29 28 FEB 20
Revision 15 10 SEP 84	Revision 10 30 JUN 05	Revision 30 21 JAN 21
Revision 16 19 NOV 84	Revision 11 30 MAR 07	Revision 31 30 APR 21
Revision 17 15 APR 86	Revision 12 27 FEB 09	Revision 32 04 MAR 22
Revision 18 03 JUN 87	Revision 13 29 OCT 09	
Reissue 0 29 MAR 90	Revision 14 14 JUN 10	

LOG OF PAGES

Page No.	Rev No.	Page No.	Rev No.	Page No.	Rev No.
VOLUME 1		VOLUME 2		11/12	28
Cover	28	Cover	28	13 – 22	28
Title	32	Title	32	23 – 30	31
PN	28	PN	28	30A/30B	31
Warning	28			31 – 33	28
CSS	30	Chapter 4		34 – 35	29
A – J	32	1 – 3	24	36	30
Help	28	4	30	37	28
Customer Feedback	30	5 – 6	27	38	29
Helicopter Sales Notice	30	7	30	39 – 49	28
Warranty	28	8 – 14	27	50	31
BR	28	15	30	51 – 52	28
TR	32	16	24	53/54	28
i/ii	16			55 - 61	28
Chapter 1		Chapter 5		62 – 63	31
1/2	22	1 – 2	32	64 – 65	29
3	23	3/4	32	66 – 75	28
4 – 8	22	5 – 7	28	76	30
		8	30	77	29
		9 – 10	28	78	31



LOG OF PAGES (CONT)

Page No.	Rev No.	Page No.	Rev No.	Page No.	Rev No.
79.....	29	217 – 218	29	10 – 12.....	11
80.....	31	219/220	29	13/14.....	20
81 – 83.....	29	221 – 224	29	Chapter 11	
84 – 88.....	28	225/226	29	1/2.....	25
89/90.....	28	227 – 238	29	3 – 18.....	25
91 – 97.....	28	239/240	29	19.....	29
98 – 100.....	31	241 – 244	29	20 – 30.....	25
101 – 104.....	28	245/246	29	Chapter 12	
105/106.....	28	247 – 250	29	1 – 2.....	19
107 - 109	28	251/252	29	3	16
110.....	29	253 – 262	29	4.....	23
111 – 119	28	263	30	5 – 14.....	19
120 – 121.....	31	264 – 270	29	14A – 14D.....	19
122 – 123.....	29	271/272	31	15 – 16.....	15
124.....	28	Chapter 6		17 – 19.....	23
125.....	31	1/2	0	20.....	15
126 – 128.....	28	3 – 8	0	21.....	16
129/130.....	28	Chapter 7		22.....	29
131/132.....	28	1/2	11	23 – 24.....	16
133/134.....	28	3 – 4	11	Chapter 18	
135/136.....	31	5.....	29	1.....	12
137/138.....	28	6.....	11	2.....	32
139 – 140.....	28	Chapter 8		3.....	19
141/142.....	28	1.....	25	4.....	32
143/144.....	28	2 – 18	24	5/6.....	12
145/146.....	32	19 – 20	29	7/8.....	10
146A/146B.....	30	21 – 32	24	9 – 12.....	12
146C – 146D	30	33 – 35	25	13.....	10
147 – 148.....	28	36 – 37	29	14.....	28
149/150.....	28	38 – 39	25	15 – 20.....	10
151/152.....	28	40 – 41	24	21.....	28
153 – 158.....	28	42.....	25	22 – 34.....	10
159/160.....	28	43 – 52	24	35.....	28
161 – 162.....	28	53/54	24	36.....	12
162A/162B.....	32	Chapter 9		37 – 40.....	10
163 – 174.....	28	1/2	11	41.....	12
175/176.....	28	3 – 6	11	42 – 54.....	10
177/178.....	31	7/8	11	55 – 56.....	19
179 – 180.....	28	Chapter 10		56A/56B.....	19
181/182.....	28	1/2	12	57.....	15
183 – 186.....	30	3	20	58 – 66.....	10
187 – 196.....	28	4.....	11	67 – 68.....	15
197 – 198.....	30	5.....	12	69 – 91.....	10
199/200.....	30	6.....	11	92.....	32
201 – 202.....	28	7 – 9	12	92A – 92B.....	32
203/204.....	28			93 – 94.....	10
205.....	29			95.....	12
206 – 212.....	28				
213/214.....	28				
215/216.....	28				



LOG OF PAGES (CONT)

Page No.	Rev No.	Page No.	Rev No.	Page No.	Rev No.
96 – 100	10	Chapter 28		82A/82B	26
101	15	1.....	11	83	26
102 – 103	10	2 – 4.....	26	84	11
104	15	4A	12	85 – 86	26
105 – 108	10	4B – 4C.....	26	86A – 86D	11
		4D.....	12	87	11
VOLUME 3		5 – 6.....	12	88 – 89	26
Cover	29	7/8.....	25	90	11
Title	29	9.....	31	91 – 92	26
PN	29	10 – 13.....	7	93 – 94	11
		14 – 18.....	11	94A – 94D	11
Chapter 21		19 – 20.....	7	95	7
1 – 2.....	25	21 – 23.....	11	96	11
2A/2B	25	24.....	7	97	7
3.....	25	25.....	11	98	11
4 – 26.....	10	26.....	7	99 – 100	23
27 – 36.....	25	27.....	11	100A/100B	26
		28.....	7	101	26
Chapter 25		29 – 31.....	11	102	11
1 – 2.....	13	32.....	7	103 – 105	26
3 – 4.....	12	33.....	11	106.....	7
4A – 4D	12	34 – 41.....	7	107 – 110	11
4E/4F	7	42.....	26	111 – 112.....	13
5 – 6.....	4	42A – 42B.....	26	112A/112B.....	13
6A.....	13	43 – 47.....	7	113 – 115.....	11
6B.....	12	48.....	11	116	7
7 – 10.....	0	49.....	7	117 – 122	11
11 – 12	13	50 – 52.....	11	123 – 125	12
13 – 38.....	0	53.....	7	126.....	11
		54.....	11	127 – 128	12
Chapter 26		55 – 56.....	7	128A.....	13
1 – 2.....	21	57.....	11	128B.....	15
3/4.....	11	58.....	7	129 – 134	11
5 – 8.....	21	59 – 60.....	11	135.....	15
8A/8B	29	61.....	7	136 – 138	11
9 – 12.....	11	62.....	11	138A/138B	26
13.....	29	63.....	7	139.....	26
14 – 15.....	12	64.....	26	140.....	23
16.....	19	64A/64B.....	26	141.....	15
17.....	12	65.....	7	142 – 145	11
18 – 19.....	11	66.....	26	146.....	29
20 – 21.....	12	67.....	7	147 – 148	12
22.....	11	68.....	26	148A.....	26
23/24.....	12	68A/68B.....	26	148B.....	29
		69.....	7	149.....	29
VOLUME 4		70.....	11	150.....	11
Cover	29	71 – 74.....	7	151 – 152	26
Title	31	75.....	12	153 – 155	11
PN	29	76 – 81.....	7	156 – 158	12
		82.....	15	158A/158B	12



LOG OF PAGES (CONT)

Page No.	Rev No.	Page No.	Rev No.	Page No.	Rev No.
159.....	11	50.....	12	52 – 53.....	15
160.....	26	51/52.....	11	54 – 58.....	13
160A/160B.....	26			59.....	15
161.....	26	VOLUME 5		60.....	13
162.....	11	Cover.....	29	61 – 62.....	15
163 – 164.....	12	Title.....	32	62A/62B.....	15
164A/164B.....	12	PN.....	29	63 – 68.....	13
165.....	12			69/70.....	13
166 – 174.....	11	Chapter 30		71 – 74.....	13
175.....	23	1/2.....	11	75 – 77.....	16
176 – 186.....	11	3/4.....	11	78.....	13
		5.....	11	79/80.....	16
Chapter 29		6.....	20		
1.....	16	7.....	13	Chapter 52	
2.....	20	8 – 10.....	11	1 – 2.....	26
3/4.....	11			3.....	32
5.....	19	Chapter 32		4.....	26
6.....	11	1 – 2.....	15	5.....	11
7 – 8.....	20	3.....	16	6.....	13
9 – 10.....	11	4.....	15	7 – 9.....	11
11.....	29	5/6.....	13	10.....	12
12 – 17.....	11	7 – 9.....	15	11 – 16.....	11
18.....	15	10.....	31	17 – 21.....	25
19/20.....	15	11.....	13	22.....	29
21.....	11	12.....	20	22A – 22B.....	25
22 – 23.....	20	13.....	13	22C/22D.....	25
24.....	11	14.....	14	23 – 26.....	11
25.....	16	15 – 17.....	13	26A – 26L.....	26
26.....	11	18.....	14	27.....	12
27 – 28.....	16	19 – 20.....	13	28 – 29.....	11
29.....	29	21.....	20	30.....	19
30.....	11	22 – 23.....	13	31.....	11
31.....	16	24.....	14	32.....	12
32.....	11	25 – 28.....	13	33.....	11
33.....	16	29.....	20	34 – 35.....	12
34.....	29	30.....	13	36 – 39.....	11
35.....	11	31.....	15	40.....	29
36 – 38.....	29	32.....	13	41.....	11
39.....	11	32A/32B.....	20	42.....	25
40.....	12	33 – 35.....	13	43 – 44.....	11
41.....	11	36.....	15	45.....	12
42.....	20	37.....	13	46.....	32
42A/42B.....	20	38.....	15	46A – 46B.....	32
43 – 44.....	11	39.....	13	47 – 50.....	32
45.....	15	40.....	29	51.....	15
46.....	11	41 – 43.....	15	52.....	29
47.....	29	44.....	13	53 – 55.....	25
48.....	12	45.....	14	56.....	29
49.....	11	46 – 51.....	13	57 – 58.....	25



LOG OF PAGES (CONT)

Page No.	Rev No.	Page No.	Rev No.	Page No.	Rev No.
59 – 62	26	43	10	88	19
Chapter 53		44	29	89 – 92	11
1 – 4	15	45	10	93 – 95	20
5	31	46	28	96	11
6 – 7	15	47 – 49	10	97	29
8	31	50 – 51	28	98 – 101	11
9 – 17	15	52 – 54	29	102	12
18	31	55	10	103/104	11
19 – 22	15	56	12	105	11
23/24	15	57 – 60	29	106	19
VOLUME 6		Chapter 63		107 – 110	11
Cover	28	1	29	111 – 115	15
Title	32	2 – 6	20	116	11
PN	28	7 – 8	29	117 – 120	15
Chapter 62		9/10	20	121	12
1	28	11 – 14	29	122 – 124	11
2	29	14A/14B	29	125 – 127	31
2A/2B	12	15	11	128	11
3	12	16	15	129	31
4	10	17 – 18	19	130	11
5 – 8	28	19 – 21	11	131	15
8A	15	22	15	132	11
8B	12	23	20	133 – 134	15
8C/8D	15	24	23	135	11
9	28	25 – 27	20	136 – 137	15
10 – 12	10	28	12	138	11
13 – 14	23	28A – 28B	20	139/140	15
15	10	29 – 33	29	141	15
16	28	34	11	142	11
17	23	35 – 36	29	143	28
18	28	36A – 36B	29	144	15
19	15	37 – 38	11	145	11
20	28	39 – 42	21	146 – 148	15
21 – 22	10	43	11	149	12
23 – 24	28	44 – 48	21	150	11
25 – 27	10	48A – 48B	21	151/152	12
28	12	49	32	153 – 160	11
29	10	50	15	161	19
30	28	51/52	15	162 – 167	11
31	29	53	19	168 – 169	19
32 – 33	10	54	23	170	11
34 – 35	29	55	11	171 – 172	19
36	10	56 – 58	23	VOLUME 7	
37 – 38	29	59	12	Cover	28
39	10	60 – 65	11	Title	31
40 – 42	29	66	12	PN	28
		67 – 85	11		
		86 – 87	15		



LOG OF PAGES (CONT)

Page No.	Rev No.	Page No.	Rev No.	Page No.	Rev No.
Chapter 64		55 – 56	5	41.....	7
1 – 2.....	29	57.....	19	42 – 43.....	20
3.....	28	58.....	5	44.....	7
4.....	19	59.....	31	45.....	16
5 - 7	28	60.....	19	46 – 47.....	20
8.....	29	61 – 68	21	48 – 49.....	7
9 - 24	28	69/70	21	50.....	16
25 - 26	29			51.....	15
27	19	VOLUME 8		52.....	23
28	29	Cover	29	53.....	12
29.....	19	Title	32	54.....	15
30 - 31	29	PN.....	29	55.....	16
32.....	28			56 – 58.....	15
33 - 36	29	Chapter 67		59 – 61.....	30
Chapter 65		1.....	30	62 – 66.....	7
1.....	15	2.....	29	67.....	31
2 – 4.....	21	3 – 4	30	68.....	7
5.....	15	5.....	21	69.....	11
6.....	16	6.....	29	70.....	30
7 – 12.....	15	7 – 9	21	70A/70B.....	31
12A	15	10.....	29	71.....	30
12B – 12C.....	16	10A/10B	21	72.....	29
12D.....	15	11/12	12	73.....	30
13.....	16	13.....	12	74.....	29
14.....	11	14 – 16	11	74A – 74B.....	30
15.....	7	16A.....	12	75 – 78.....	7
16 – 17.....	16	16B.....	29	79 – 84.....	12
18.....	15	16C/16D.....	20	85.....	7
18A/18B.....	15	17.....	12	86.....	12
19.....	15	18.....	11	87.....	7
20 – 23.....	5	19.....	13	88.....	12
24.....	15	20.....	11	89 – 93.....	20
25 – 26.....	5	21.....	7	94.....	21
27 – 34.....	16	22.....	15	95 – 96.....	20
34A – 34B	16	22A/22B	11	97 – 98.....	21
35 – 36.....	12	23 – 24	7	98A	20
37 – 38.....	5	25.....	12	98B – 98C.....	21
39.....	7	26.....	29	98D	20
40 – 43.....	11	27.....	11	98E/98F	21
44 – 46.....	19	28.....	29	99.....	25
47 – 48.....	21	29 – 31	7	100.....	29
48A – 48B	21	32.....	11	101/102.....	29
49 – 50.....	15	33.....	7	103.....	7
51.....	5	34.....	11	104.....	13
52.....	13	35 – 37	7	105 – 107.....	7
52A/52B.....	13	38.....	11	108.....	31
53.....	11	39.....	7	109.....	7
54.....	15	40.....	15	110.....	31
				111	8



LOG OF PAGES (CONT)

Page No.	Rev No.	Page No.	Rev No.	Page No.	Rev No.
112	31	181/182	7	8 – 9	30
113	29	183	7	10	11
114	32	184	23	11	15
115	29	185 – 186	11	12	30
116	30	186A/186B	11	13 – 14	15
116A	31	187 – 188	7	14A/14B	15
116B	32	189/190	7	15 – 16	15
116C	31	191/192	12	17	11
116D	29	193	12	18	15
117	29	194	7	19 – 22	11
118 – 119	30	195	13	23	13
120	31	196 – 197	7	24	25
120A/120B	31	198	12	25/26	7
121	30	198A/198B	12	27	25
122	7	199 – 200	7	28	12
123	15	201 – 202	13	29 – 30	11
124	30	203 – 206	15	30A/30B	11
125	7	206A/206B	15	31 – 33	11
126	30	207 – 213	7	34	12
126A/126B	30	214 – 215	16	35	11
127 – 134	15	216	7	36	12
135 – 136	29	217	29	37 – 38	11
137 – 138	15	218	16	39 – 40	31
138A	29	219	29	41	11
138B	15	220	11	42	25
139 – 140	7	221	7	42A/42B	25
141 – 142	20	222	12	43 – 44	30
142A/142B	20	223	29	45	13
143 – 154	7	224	12	46	7
155	12	225	29	47	9
156 – 158	7	226	12	48	13
159/160	7	227	29	49	14
161	22	228	12	50	13
162	15	229	29	50A – 50D	14
163 – 164	7	230	12	50D – 50F	30
165	29			50G/50H	30
166	7			51 – 52	7
167	13	VOLUME 9		53/54	7
168 – 169	15	Cover	30	55 – 56	7
170	12	Title	32	57 – 58	30
171	7	PN	30	59 – 68	7
172	15	Chapter 71		69	13
173	12	1	25	70	7
174 – 175	15	2	30	71	13
176	12	3	21	72	21
177	15	4	15	73 – 75	13
178	12	5	30	76 – 77	21
178A – 178B	15	6	21	78	7
179 – 180	7	7	11	79 – 81	21



LOG OF PAGES (CONT)

Page No.	Rev No.	Page No.	Rev No.	Page No.	Rev No.
82 – 90.....	7	26.....	15	16A – 16F.....	12
91.....	11	26A/26B.....	12	17.....	12
92.....	30	27.....	8	18 – 21.....	0
93.....	11	28.....	25	22 – 23.....	15
94.....	30	29.....	15	24 – 28.....	0
95.....	11	30 – 34.....	8	29 – 30.....	12
96.....	12	35.....	15	30A – 30D.....	12
97.....	13	36 – 37.....	8	30E/30F.....	12
98.....	12	38.....	25	31 – 32.....	0
99.....	7	39.....	8	33.....	15
100.....	30	40.....	25	34.....	0
101 – 102.....	12	41 – 42.....	8	35.....	12
103.....	16	43/44.....	8	36 – 38.....	0
104.....	13	45 – 46.....	15		
104A – 104B.....	13	47.....	8	Chapter 96	
105.....	11	48.....	15	1 – 200.....	25
106 – 107.....	16	49 – 58.....	8	201/202.....	25
108.....	13	59.....	12	203 – 208.....	25
108A.....	11	60 – 66.....	8	209/210.....	25
108B.....	15	67 – 72.....	15	211 – 218.....	25
109.....	30	73.....	18	219/220.....	25
110 – 115.....	7	74.....	8	221 – 240.....	25
116.....	15	75 – 76.....	30	241 – 242.....	31
117 – 119.....	7	76A/76B.....	30	243 – 276.....	25
120.....	12	77.....	18	277/278.....	25
121.....	16	78.....	8	279 – 280.....	25
122 – 124.....	7	79 – 82.....	15	280A – 280B.....	25
125.....	15	83 – 86.....	30	281 – 286.....	25
126.....	11	87/88.....	20	287/288.....	25
127 – 128.....	7			289 – 302.....	25
129 – 130.....	13	Chapter 79		303/304.....	25
131 – 132.....	30	1 – 6.....	20	305/306.....	25
133 – 134.....	13	6A/6B.....	20	307 – 336.....	25
135/136.....	30	7 – 11.....	7	337/338.....	25
		12.....	12	339 – 414.....	25
Chapter 76		13 – 16.....	7	415/416.....	25
1 – 2.....	15	17 – 18.....	32	417 – 420.....	25
3.....	30			421/422.....	25
4.....	15	VOLUME 10		423 – 584.....	25
6 – 8.....	8	Cover.....	31		
9/10.....	8	Title.....	31	VOLUME 11	
11 – 12.....	8	PN.....	31	Cover.....	28
13 – 14.....	30			Title.....	28
15.....	12	Chapter 95		PN.....	28
16 – 19.....	8	1 – 2.....	15		
20 – 22.....	13	3/4.....	15	Chapter 97	
23.....	8	5 – 10.....	0	1 – 3.....	20
24.....	13	11.....	7	4 – 8.....	23
25.....	30	12 – 16.....	12	9.....	25



LOG OF PAGES (CONT)

Page No.	Rev No.	Page No.	Rev No.	Page No.	Rev No.
10	23	44K/44L	25	141 – 142	25
11/12	23	45 – 48	12	142A/142B(Deleted)	25
13 – 47	20	49 – 50	25	143	25
48 – 49	23	51 – 52	0	144	12
50 – 57	20	53 – 54	23	145	25
58	23	55	0	146	12
59 – 82	20	56	25	147	25
83/84	20	57 – 62	21	148	12
85 – 91	20	62A – 62B	21	149 – 150	0
92	28	62C/62D	21	151 – 152	21
93 – 98	20	63 – 65	0	153 – 158	25
99 – 102	23	66 – 68	25	159	12
103/104	23	69 – 70	23	160	25
105 – 142	20	70A/70B	25	160A/160B	25
143/144	20	71 – 72	25	160C/160D	25
145 – 148	20	73 – 78	21	161 – 162	25
149/150	20	78A – 78B	21	162A/162B	31
151 – 158	20	78C/78D	21	163 – 166	0
159 – 164	25	79 – 80	25	167 – 172	25
165 – 188	20	81 – 82	0	172A – 172B	25
189/190	20	83 – 88	25	173	7
191 – 204	20	89 – 90	0	174	32
205/206	20	91 – 98	25	175 – 178	25
207 – 208	20	99	0	179 – 181	31
209/210	20	100 – 101	25	182	25
211 – 212	20	102	7	183 – 210	31
		103	12	210A	31
VOLUME 12		104 – 106	21	210B – 210F	25
Cover	28	106A – 106B	21	210G/210H	25
Title	32	106C/106D	21	211 – 214	25
PN	28	107 – 108	0	214A – 214D	25
		109 – 112	21	215 – 216	25
Chapter 98		112A – 112B	21	217 – 220	21
1 – 3	25	113 – 114	0	221 – 223	25
4	32	115 – 116	21	224	32
5/6	25	116A/116B	25	225	0
7 – 13	0	117 – 119	25	226	25
14 – 15	25	120	12	227	7
16	0	121	25	228	25
17	25	122	12	228A – 228B	20
18 – 32	0	123	25	229	16
33 – 36	21	124	12	230	25
36A – 36E	21	125 – 136	25	231 – 232	0
36F – 36L	25	136A	25	233 – 234	25
37 – 38	0	136B	21	234A/234B	25
39 – 40	20	137	25	234C – 234D	25
41 – 44	22	138	12	235 – 236	25
44A – 44E	22	139	25	237	0
44F – 44J	25	140	12	238	25



LOG OF PAGES (CONT)

Page No.	Rev No.	Page No.	Rev No.	Page No.	Rev No.
239 – 240.....	12	373 – 378.....	25	428E/428F.....	25
241 – 245.....	25	378A/378B.....	25	429 – 434.....	13
246 – 260.....	0	379 – 394.....	25	435/436.....	13
261.....	16	394A – 394D.....	25	436A – 436F.....	25
262.....	23	394E/394F.....	25	436G/436H.....	25
263 – 272.....	0	395 – 400.....	25	437 – 446.....	25
273.....	7	400A/400B.....	25	447 – 448.....	7
274 – 304.....	0	401 – 406.....	25	449 – 450.....	25
305 – 308.....	16	406A/406B.....	25	451 – 452.....	20
309 – 313.....	0	407 – 422.....	25	453/454.....	20
314 – 316.....	16	423/424.....	25		
317 – 326.....	0	425.....	25	VOLUME 13	
327 – 328.....	16	426.....	20	Cover.....	7
329 – 332.....	0	426A – 426B.....	25	Title.....	7
333.....	16	426C.....	28	PN.....	7
334.....	25	426D.....	25		
334A – 334D.....	25	426E/426F.....	28	Chapter 99	
335 – 352.....	25	427 – 428.....	20	1/2.....	7
352A/352B.....	25	428A – 428B.....	25	3/4.....	7
353 – 372.....	25	428C.....	28		
372A/372B.....	25	428D.....	25		

H ELP

E VALUATE

L OGISTICS

P UBLICATIONS

Have you found something wrong with this manual — an error, an inconsistency, unclear instructions, etc.? Although we strive for accuracy and clarity, we may make errors on occasion. If we do and you discover it, we would appreciate your telling us about it so that we can change whatever is incorrect or unclear. Please be as specific as possible.

Your complaint or suggestion will be acknowledged and we will tell you what we intend to do.

You may use the enclosed Customer Feedback form, as applicable, to inform us where we have erred.

Your assistance is sincerely appreciated.



CUSTOMER FEEDBACK

RETURN VIA FAX TO PRODUCT SUPPORT ENGINEERING (450) 433-0272

Manual Title: _____

Manual Number (if assigned): _____

Date of Issue: _____

Date of Last Revision: _____

Section, Chapter, Paragraph Affected: _____

Your Feedback: _____

Now Reads: _____

Should Read: _____

Your Name: _____

Address: _____

Position: _____ **Telephone No.:** _____

Company: _____ **Fax No.:** _____

Reference No. (your initials and date): _____

(If you choose to mail this form, fold in thirds with address exposed, tape and mail.)

TAPE HERE

From _____

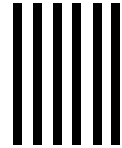

POSTAGE
NECESSARY

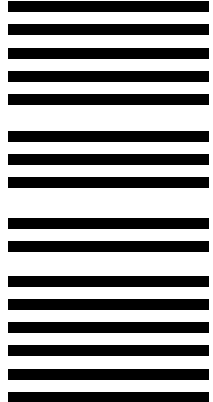

Product Support Engineering
12,800 rue de l'Avenir
Mirabel, Québec, Canada, J7J 1R4

FOLD ON DOTTED LINES AND TAPE

TAPE HERE

IMPORTANT
HELICOPTER SALES NOTICE

Please complete this form and return by mail, e-mail (publications@bellflight.com), or fax (817-280-6466, Attention: CPDC). This will ensure that the new owners/operators receive updates to their **Bell Textron Technical Manuals** and **Bulletins**.

Model of Helicopter Sold or Purchased _____

Serial and Registration Number _____

Name of **New Owner** (company or individual) _____

Name of **New Operator** _____

Future Publications to be mailed to this address:

Address _____

City _____

State/Province _____

Zip/Postal Code _____

Country _____

Fax No. _____ Telephone No. _____

E-mail Address _____

Register for access to electronic publications at www.mybell.com

TAPE HERE

From _____

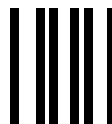

NO POSTAGE
NECESSARY
IF MAILED
IN THE
UNITED STATES

BUSINESS REPLY MAIL
FIRST CLASS PERMIT NO. 1744 FORT WORTH, TEXAS



**COMMERCIAL PUBLICATION DISTRIBUTION CENTER
P.O. BOX 482
FORT WORTH, TEXAS 76101-0482**

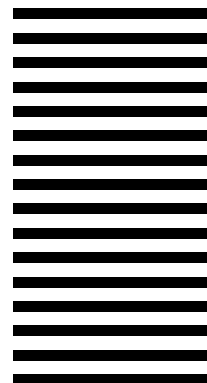

FOLD ON DOTTED LINES AND TAPE

TAPE HERE



SPARE PARTS WARRANTY

WARRANTY: Seller warrants each new helicopter part or helicopter part reconditioned by Seller to be free from defect in material and workmanship under normal use and service and if installed on Bell model helicopters for up to 1000 hours of operation, one (1) year from date of installation, or two (2) years from date of shipment by Seller, whichever occurs first. Seller assigns each manufacturer's warranty to Buyer to the extent such manufacturer's warranty exists and is assignable.

Parts, components and assemblies of all helicopter parts may have been restored or reworked due to marks, blemishes, dents or other irregularities during the manufacturing process. Such restoration and/or rework are permitted under Seller's approved manufacturing and engineering processes and guidelines. The restoration and/or rework so completed do not render such items defective in material or workmanship.

Seller's sole obligation under this warranty is limited to the repair or replacement of parts which are determined to Seller's reasonable satisfaction to have been defective within the applicable warranty period as described above. Replacement of parts may be either new or reconditioned at Seller's election and at the lowest allowable maintenance level contained in Seller's manuals, service bulletins or applicable supplier manuals. Seller shall also reimburse reasonable freight charges, excluding insurance, customs fees, duties, handling fees, and taxes. Seller shall not reimburse Buyer for any parts repaired or replaced outside of the Seller's Warranty Claims Process unless express prior written authorization is granted by Seller's Warranty Department to Buyer for such repair or replacement.

NO FAULT FOUND: In the event Seller determines, after evaluation of a returned part, that a defect does not exist, then Buyer shall pay all expenses incurred by Seller related to the return including, but not limited to, costs incurred in shipping and evaluating the part and cost for any replacement part and restocking of the part. In addition, Seller shall not reimburse Buyer for any costs related to the removal or reinstallation of such a part.

WARRANTY CLAIM PROCESS: Defective parts must be reported in writing to the Seller's Warranty Administration within fourteen (14) days of being found defective. Parts may be repaired or replaced with new or reconditioned parts, at Seller's election. Warranty adjustment is contingent upon the Buyer complying with the Seller's Warranty Process as described in the Bell Helicopter VISTA Customer Portal and with the Seller's Warranty Administration disposition instructions for defective parts. Failure to properly comply with Seller's Warranty Process may, at Seller's sole option, void Seller's warranty as to the allegedly defective part.

RETURN SHIPMENT: Parts returned to Seller will be eligible for remedy under this warranty only if the part is carefully packed by the Buyer for the return shipment. Damage occurring to a part due to improper packaging may result in the denial of a warranty claim. In the event that Seller determines a returned part to be damaged or unsalvageable due to improper packaging, the Buyer will be billed repair or replacement cost incurred by Seller. The party initiating shipment bears the risk of loss or damage to parts in transit.



CORE RETURNS: Any core removed by Buyer for which Seller has furnished a replacement part through the Warranty Process shall be shipped by Buyer, with all historical service records, to a facility designated by Seller, within fourteen (14) days of receipt by Buyer of the replacement part. Buyer shall provide Seller with proof of shipment within fourteen (14) days following receipt of the replacement part. In the event that Buyer fails to provide Seller with such proof of shipment within the fourteen (14) days or fails to provide the applicable historical service records, Buyer shall be charged the invoiced value of the replacement part.

WARRANTY AND LIABILITY DISCLAIMERS AND EXCLUSIONS: THIS WARRANTY IS GIVEN AND ACCEPTED IN PLACE OF (i) ALL OTHER WARRANTIES OR CONDITIONS, EXPRESS OR IMPLIED, INCLUDING BUT NOT LIMITED TO THE IMPLIED WARRANTIES OR CONDITIONS OF MERCHANTABILITY OR FITNESS FOR A PARTICULAR PURPOSE AND (ii) ANY OBLIGATION, LIABILITY, RIGHT, CLAIM OR REMEDY IN CONTRACT OR IN TORT, INCLUDING PRODUCT LIABILITIES BASED UPON STRICT LIABILITY, NEGLIGENCE, OR IMPLIED WARRANTY IN LAW.

This warranty is the only warranty made by Seller. The Buyer's sole remedy for a breach of this warranty or any defect in a part is the repair or replacement of the helicopter part and reimbursement of reasonable freight charges. Seller excludes liability, whether as a result of a breach of contract or warranty, negligence or strict product liability, for incidental or consequential damages, including without limitation, damage to the helicopter or other property, costs and expenses resulting from required changes or modifications to helicopter components and assemblies, changes in retirement lives and overhaul periods, local customs fees and taxes, and costs or expenses for commercial losses or lost profits due to loss of use or grounding of helicopters or otherwise.

Seller makes no warranty and disclaims all liability in contract or in tort, including, without limitation, negligence and strict tort liability, with respect to work performed by third parties at Buyer's request and with respect to engines, engine accessories, batteries, radios, and avionics.

Seller makes no warranty and disclaims all liability with respect to components or parts damaged by, or worn due to, normal wear and tear, erosion or corrosion. Seller makes no warranty and disclaims all liability for consumables which are defined as items required for normal and routine maintenance or replaced at scheduled intervals shorter than the warranty period. "Consumables" include but are not limited to engine and hydraulic oil, oil filters, packings and o-rings, anti-corrosion and/or sealing compounds, brush plating material, nuts, bolts, washers, screws, fluids, compounds, and standard aircraft hardware that is readily available to aircraft operators from sources other than Seller.

This warranty shall not apply to any helicopter part which has been repaired or altered outside Seller's factory in any way so as, in Seller's sole judgment, to affect its stability, safety or reliability. This warranty shall not apply to any helicopter part which has been subject to misuse, negligence or accident, or which has been installed in any aircraft which has been destroyed. Repairs and alterations which use or incorporate parts and components other than genuine Bell parts or parts approved by Bell for direct acquisition from sources other than Bell itself are not warranted by Bell, and this warranty shall be void to the extent that such repairs and alterations,



in Seller's sole judgment, affect the stability, safety or reliability of the helicopter or any part thereof, or damage genuine Bell or Bell-approved parts. No person, corporation or organization, including Bell Authorized Customer Service Facilities, is authorized by Seller to assume for it any other liability in connection with the sale of its helicopters and parts.

NO STATEMENT, WHETHER WRITTEN OR ORAL, MADE BY ANY PERSON, CORPORATION OR ORGANIZATION, INCLUDING BELL AUTHORIZED CUSTOMER SERVICE FACILITIES, MAY BE TAKEN AS A WARRANTY NOR WILL IT BIND SELLER.

CHOICE OF LAW AND JURISDICTION: This warranty shall be interpreted under and governed by the laws of the State of Texas. All legal actions based upon claims or disputes pertaining to or involving this warranty including, but not limited to, Seller's denial of any claim or portion thereof under this warranty, must be filed in the courts of general jurisdiction of Tarrant County, Texas or in the United States District Court for the Northern District of Texas, Ft. Worth Division located in Ft. Worth, Tarrant County, Texas. In the event that Buyer files such an action in either of the court systems identified above, and a final judgment in Seller's favor is rendered by such court, then Buyer shall indemnify Seller for all costs, expenses and attorneys' fees incurred by Seller in defense of such claims. In the event Buyer files such a legal action in a court other than those specified, and Seller successfully obtains dismissal of that action or transfer thereof to the above described court systems, then Buyer shall indemnify Seller for all costs, expenses and attorneys' fees incurred by Seller in obtaining such dismissal or transfer.



BULLETIN RECORD

This Bulletin Record provides a current listing of applicable bulletins that have been incorporated in this manual. Subsequent applicable bulletins will be incorporated in future revisions/reissues.

ALERT SERVICE BULLETINS

ASB NUMBER	SUBJECT	DATE
 412-15-169	LCR 100 Attitude Heading Reference Unit (AHRU) P/N 145130-7000 and P/N 145130-7001 Upgrade to P/N 145130-7010	18 December 2015

 This and all previously issued applicable bulletins have been incorporated, except 412-10-138, 412-10-143, 412-12-151, 412-12-154, 412-13-156, 412-14-160, 412-15-163, and 412-15-165.

TECHNICAL BULLETINS

TB NUMBER	SUBJECT	DATE
 412-17-240	Hydraulic Systems #1 and #2 Accumulator P/N 212-076-007- 003, Removal of	24 May 2017

 This, and all previously issued applicable bulletins, have been incorporated except 412-01-178, 412-04-199, 412-07-211, 412-08-216, 412-13-230, 412-15-233, 412-16-237, and 412-16-238.



TEMPORARY REVISION RECORD

This Temporary Revision Record provides a current listing of active Temporary Revisions against the manual. Temporary Revisions, which have been canceled/incorporated, will only be maintained on the record until the next revision is issued. If there are no Temporary Revisions shown on the record, this is confirmation that there are no Temporary Revisions issued against the manual.

TEMP. REV. NO.	TITLE	DATE ISSUED	DATE CANCELED
412-MM-05-TR01	Passenger Door Windows	25 OCT 2021	04 MAR 2022



LIST OF CHAPTERS

Title	Chapter
Introduction	1
Airworthiness Limitations Schedule	4
Inspections	5
Dimensions and Charts	6
Lifting and Jacking	7
Weight and Balance	8
Towing	9
Parking and Mooring	10
Placards and Markings	11
Servicing	12
Vibration and Noise Analysis	18
Air Distribution (Ventilation)	21
Equipment and Furnishings	25
Fire Protection	26
Fuel System	28
Hydraulic System	29
Ice and Rain Protection	30
Landing Gear	32
Doors and Windows	52
Fuselage	53
Main Rotor	62
Main Rotor Drive System	63
Tail Rotor	64
Tail Rotor Drive System	65
Flight Controls	67
Power Plant	71
Engine Controls	76
Engine Oil System	79
Instrument System	95
Electrical System	96
Avionics	97
Wiring Diagrams	98
Kits	99

Bell
MODEL **412/412EP**

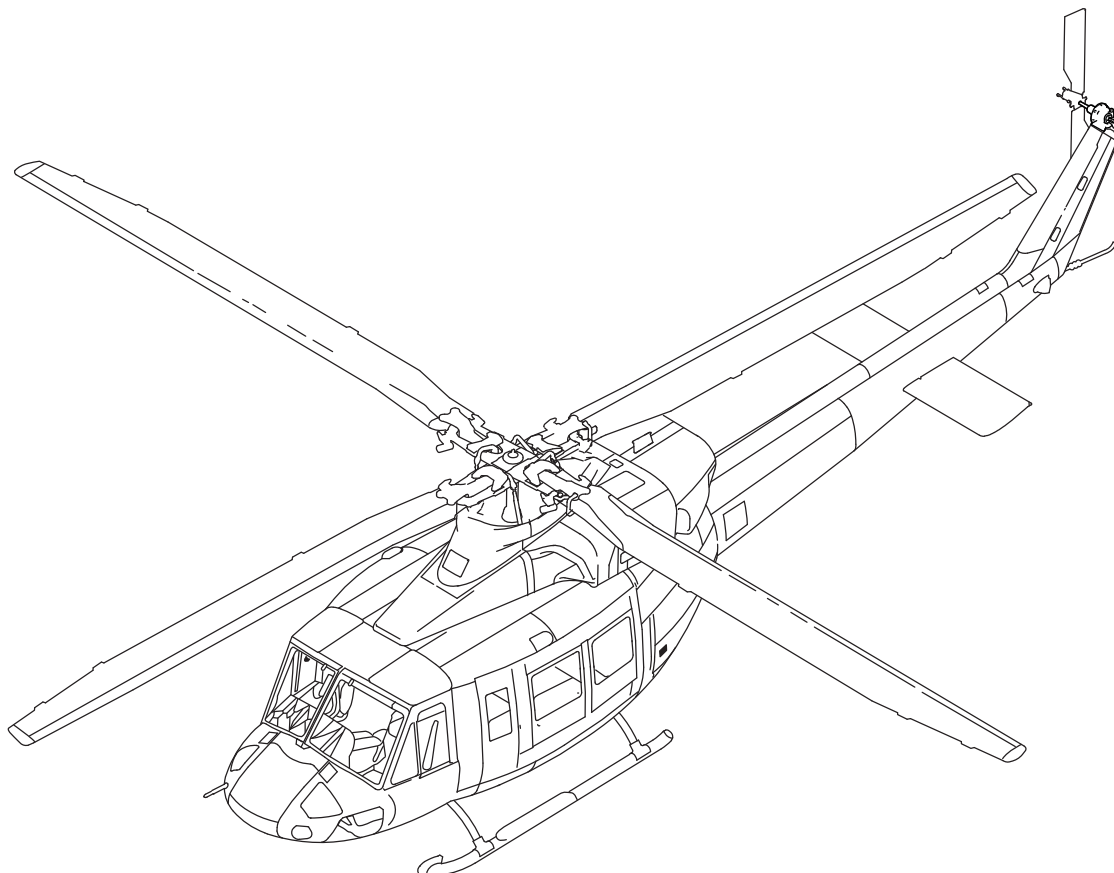

MAINTENANCE MANUAL
VOLUME 2
HANDLING AND SERVICING

NOTICE

The instructions set forth in this manual, as supplemented or modified by Alert Service Bulletins (ASB) or other directions issued by Bell Textron Inc. and Airworthiness Directives (AD) issued by the applicable regulatory agencies, shall be strictly followed.

COPYRIGHT NOTICE
COPYRIGHT 2022
BELL TEXTRON INC. AND
BELL TEXTRON CANADA LIMITED.

ALL RIGHTS RESERVED



POST OFFICE BOX 482 • FORT WORTH, TEXAS 76101

REISSUE — 23 JUNE 1994
REVISION 32 — 04 MARCH 2022



PROPRIETARY RIGHTS NOTICE

These data are proprietary to Bell Textron Inc. Disclosure, reproduction, or use of these data for any purpose other than helicopter operation or maintenance is forbidden without prior written authorization from Bell Textron Inc.

DESTINATION CONTROL STATEMENT

WARNING — This document contains technical data whose export is restricted by the Arms Export Control Act (Title 22, U.S.C., Sec 2751, et. seq.) or the Export Administration Act of 1979, as amended, Title 50, U.S.C., App. 2401 et. seq. Violations of these export laws are subject to severe criminal penalties. Disseminate in accordance with provisions of DoD Directive 5230.25.

CHAPTER 4 — AIRWORTHINESS LIMITATIONS SCHEDULE

TABLE OF CONTENTS











Paragraph Number	Title	Chapter/Section Number	Page Number
AIRWORTHINESS LIMITATIONS SCHEDULE			
4-1	Airworthiness Limitations Schedule	4-00-00	5





FIGURES

Figure Number	Title	Page Number
4-1	Longitudinal/Lateral CG Envelope for Hoist Operations	16

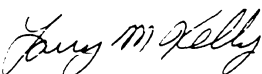

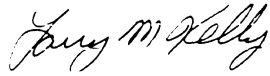
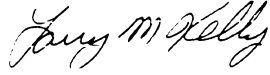

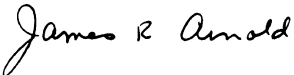
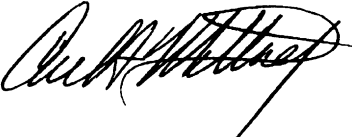

TABLES

Table Number	Title	Page Number
4-1	Airworthiness Limitations Schedule	6

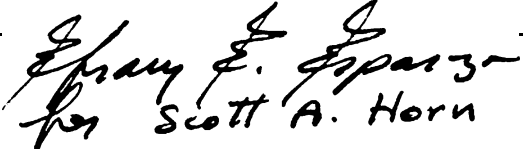
REVISION NO.	DATE OF SIGNATURE	FAA/ODA* SIGNATURE
Original	1 January 1981	
1	15 May 1981	
2	15 November 1981	
3	24 February 1982	
4	9 November 1982	
5	9 December 1982	
6	N/A	N/A
7	31 March 1983	
8	N/A	N/A
9	N/A	N/A
10	20 October 1983	
11	N/A	N/A
12	N/A	N/A
13	N/A	N/A
14	30 July 1984	
15	N/A	N/A
16	19 November 1984	
17	N/A	N/A
18	3 June 1987	

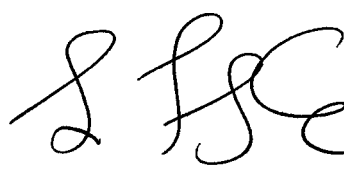
REVISION NO.	DATE OF SIGNATURE	FAA/ODA* SIGNATURE
Reissue	29 March 1990	
1	20 February 1991	
2	N/A	N/A
3	N/A	N/A
Reissue	N/A	N/A
1	N/A	N/A
Reissue	23 June 1994	
1	12 April 1995	
2	N/A	N/A
3	N/A	N/A
4	N/A	N/A
5	N/A	N/A
6	1 October 2002	
7	N/A	N/A
8	N/A	N/A
9	N/A	N/A
10	N/A	N/A
11	30 March 2007	
12	27 February 2009	
13	N/A	N/A
14	N/A	N/A



REVISION NO.	DATE OF SIGNATURE	FAA/ODA* SIGNATURE
15	1 May 2012	 for Scott A. Horn
16	N/A	N/A
17	26 March 2013	
18	N/A	N/A
19	N/A	N/A
20	N/A	N/A
21	N/A	N/A
22	N/A	N/A
23	N/A	N/A
24	15 September 2016	 S. Frances Cox
25	N/A	N/A
26	14 June 2018	 S. Frances Cox
27	25 SEP 2018	 S. Frances Cox
28	N/A	N/A
29	N/A	N/A
30	21 JAN 2021	<p data-bbox="779 1785 1023 1890">SARAH F COX</p>  <p data-bbox="1120 1785 1380 1890">Digitally signed by SARAH F COX Date: 2021.01.21 07:31:33 -06'00'</p>

AIRWORTHINESS LIMITATIONS SCHEDULE

4-1. AIRWORTHINESS LIMITATIONS SCHEDULE

The Airworthiness Limitations section is FAA approved and specifies maintenance required under Secs. 43.16 and [91.403] of the Federal Aviation Regulations unless an alternative program has been FAA approved.

WARNING

ALL REPAIR AND OVERHAUL PROCEDURES LIVES PUBLISHED BY BELL HELICOPTER TEXTRON, INCLUDING COMPONENT RETIREMENT LIFE, ARE BASED SOLELY ON THE USE OF BELL APPROVED PARTS AND PROCESSES. IF PARTS OR PROCESSES DEVELOPED OR APPROVED BY PARTIES OTHER THAN BELL HELICOPTER ARE USED, THEN THE DATA PUBLISHED OR OTHERWISE SUPPLIED BY BELL HELICOPTER ARE NOT APPLICABLE. THE USER IS WARNED TO NOT RELY ON BELL HELICOPTER DATA FOR PARTS AND PROCESSES NOT APPROVED BY BELL HELICOPTER. ALL APPLICABLE INSPECTIONS AND REPAIR METHODS MUST BE OBTAINED FROM THE SUPPLIER OF THE PARTS OR PROCESSES NOT APPROVED BY BELL HELICOPTER. BELL HELICOPTER IS NOT RESPONSIBLE FOR PARTS OR PROCESSES OTHER THAN THOSE WHICH IT HAS ITSELF DEVELOPED OR APPROVED.

WARNING

CONTINUED USE OF ANY TIME/ CALENDAR/RIN LIFE LIMITED

COMPONENT PAST ITS STATED LIMITS IS NOT PERMITTED AS IT COULD SERIOUSLY AFFECT THE AIRWORTHINESS OF THE HELICOPTER.

THE COMPONENT MUST BE REMOVED FROM THE HELICOPTER NOT LATER THAN THE END OF THE LIFE LIMIT. IT MUST EITHER BE MADE UNSERVICEABLE OR MARKED IN A CONSPICUOUS MANNER TO PREVENT CONTINUED USE, EVEN INADVERTENT USE.

WHEN A REPLACEMENT PART IS INSTALLED, THE PART NAME, PART NUMBER, SERIAL NUMBER, AND CURRENT OPERATING HOURS, IF APPLICABLE, MUST BE RECORDED IN THE HISTORICAL SERVICE RECORD FOR THE ASSEMBLY OR HELICOPTER.

The mandatory airworthiness limitations schedule ([Table 4-1](#)) summarizes the mandatory maximum life, in hours, years or by Retirement Index Number (RIN) of components with a limited airworthiness life. Parts that are not on the schedule have an unlimited airworthiness life.

Refer to the engine manufacturer's publications for the airworthiness limitations schedule of the engine and components. For the PT6T-3 series engine, refer to the Pratt and Whitney Service Bulletin No. 5002. For the PT6T-9 Engine, refer to the Pratt and Whitney Maintenance Manual airworthiness limitation section.

NOTE

The airworthiness life or inspection interval for any part number contained in this schedule applies to all the successive dash numbers for that component unless it is otherwise specified.

WARNING

SOME PARTS ARE INSTALLED AS ORIGINAL EQUIPMENT ON BOTH MILITARY AND COMMERCIAL HELICOPTERS AND MAY HAVE A LOWER AIRWORTHINESS LIFE AND/OR OVERHAUL SCHEDULE WHEN USED ON A MILITARY HELICOPTER. IN ADDITION, CIRCUMSTANCES SURROUNDING THEIR USE MAY CALL FOR OPERATION OF THE MILITARY HELICOPTER OUTSIDE OF THE APPROVED COMMERCIAL FLIGHT ENVELOPE. CONSEQUENTLY, PARTS THAT HAVE BEEN USED ON MILITARY HELICOPTERS SHOULD NOT BE USED ON COMMERCIAL HELICOPTERS.

CAUTION

AIRWORTHINESS LIFE OF SOME KIT COMPONENTS MAY NOT BE COVERED IN THIS SCHEDULE. REFER TO

APPLICABLE SERVICE INSTRUCTION (SI) OR MAINTENANCE MANUAL SUPPLEMENT (MMS) FOR KIT COMPONENTS SCHEDULE.

NOTE

The airworthiness life given or the failure to give an airworthiness life to a component does not constitute a warranty of any kind. The only warranty applicable to the helicopter or any component is the warranty included in the Purchase Agreement for the helicopter or the component.

The airworthiness lives given to the components and assemblies are determined by experience, tests and the judgement of Bell Helicopter engineers. The airworthiness lives and inspection intervals cannot be changed without the approval of the FAA.

Prior to disposing of unsalvageable helicopter parts and materials, caution should be exercised to ensure that the parts and materials are disposed of in a manner that does not allow them to be returned for service. Refer to FAA Advisory Circular 21-38 for guidance on the disposal of unsalvageable aircraft parts and materials.

Table 4-1. Airworthiness Limitations Schedule









NOMENCLATURE	PART NUMBER 	AIRWORTHINESS LIFE
MAIN ROTOR HUB		
Yoke Assembly	412-010-101-109	700 hours
Yoke Assembly	412-010-101-123	   5000 hours
Yoke Assembly	412-010-101-137	  4500 hours
Yoke Assembly	412-010-101-139	  3000 hours
Spindle Assembly	412-010-156-105	 5000 hours
Spindle and Damper Bearing Assembly	412-010-190-101	5000 hours
Spindle and Damper Bearing Assembly	412-010-190-103	10,000 hours
Spindle and Shear Bearing Assembly	412-310-102-101	10,000 hours



Table 4-1. Airworthiness Limitations Schedule (Cont)









NOMENCLATURE	PART NUMBER 	AIRWORTHINESS LIFE
MAIN ROTOR HUB (CONT)		
Pitch Horn Assembly	412-010-149-105	5000 hours
Pitch Horn Assembly	412-010-149-111	15,000 hours
Retention Bolt	412-010-124-105	 5000 hours
Retention Bolt (Expandable)	412-010-137-103	5000 hours
Damper Bridge	412-010-104-101	5000 hours
Damper Bridge	412-010-183-101	10,000 hours
Damper Bridge	412-010-183-109	15,000 hours
Damper Bridge	412-010-185-101	10,000 hours
Damper Bridge	412-010-185-109	15,000 hours
Damper Bridge	412-018-068-101	 10,000 hours or 180 months
Damper Bridge	412-010-170-101	 10,000 hours or 180 months
Pivot Bearing	412-010-106-101	 On condition
Fitting	412-010-111-101	5000 hours
Damper Yoke Set	412-010-145-101	 On condition
Damper Yoke Set	412-310-146-103	 On condition
MAIN ROTOR DROOP RESTRAINT		
Bolt (8)	MS21250H05006	 120 months
MAIN ROTOR SIMPLE PENDULUM ABSORBERS		
Bolt, Bracket (16)	EWB0420D-7-36	15,000 hours
MAIN ROTOR CONTROLS		
Rephasing Lever Assembly	412-010-403-109	1250 hours
Rephasing Lever Assembly	412-010-403-113	5000 hours
Drive Link Assembly	412-010-405-101	5000 hours
Swashplate Outer Ring	412-010-407-105	 2500 hours

Table 4-1. Airworthiness Limitations Schedule (Cont)

























NOMENCLATURE	PART NUMBER 	AIRWORTHINESS LIFE
MAIN ROTOR CONTROLS (CONT)		
Swashplate Outer Ring	412-010-407-117	10,000 hours
Pitch Link Rod End Bearing	412-010-412-101	5000 hours
Pitch Link Rod End Bearing	412-010-438-101	5000 hours
Swashplate Link Rod End Bearing	412-010-412-101	5000 hours
Swashplate Link Rod End Bearing	412-010-448-101	5000 hours
Swashplate Link Rod End Bearing	412-310-400-103	 5000 hours
Swashplate Support Assembly	412-010-409-105	 5000 hours
Swashplate Support Assembly	412-010-443-101	 5000 hours
Swashplate Support Assembly	412-010-453-101	 5000 hours
Swashplate Support Assembly	412-010-453-105	15,000 hours
Gimbal Ring Assembly	204-010-404-001	9000 hours
Gimbal Ring Assembly	212-010-416-101	9000 hours
Collective Sleeve	204-011-408-003	9000 hours
Collective Sleeve	212-011-412-101	9000 hours
Collective Lever Assembly	412-010-408-101	 10,000 hours
Collective Lever Assembly	412-010-408-105	 2500 hours
Collective Lever Assembly	412-010-464-101	20,000 hours
Collective Lever Pin	412-010-465-101	20,000 hours
MAIN ROTOR CONTROL SYSTEM BOLTS		
Pitch Horn to Pitch Link (4)	20-057-5-25D	   2500 hours
Pitch Horn to Pitch Link (4)	20-057-5-28D	 2500 hours
Pitch Link-to-Rephasing Lever (4)	20-057-6-36D	   2500 hours
Pitch Link-to-Rephasing Lever (4)	20-057-6-52D	  2500 hours
Drive Link-to-Rephasing Lever (4)	20-057-6-36D	   2500 hours
Swashplate Link-to-Rephasing Lever (3)	20-057-6-38D	   2500 hours
Swashplate Link-to-Rephasing Lever (2)	20-057-6-52D	  2500 hours

Table 4-1. Airworthiness Limitations Schedule (Cont)









































NOMENCLATURE	PART NUMBER 	AIRWORTHINESS LIFE
MAIN ROTOR CONTROL SYSTEM BOLTS (CONT)		
Swashplate Link-to-Rotating Ring (2)	20-057-6-36D	   2500 hours
Gimbal Ring-to-Swashplate Support (2)	204-011-463-105	   2500 hours
Gimbal Ring-to-Swashplate Inner Ring (2)	204-011-463-001	   1000 hours
Gimbal Ring-to-Swashplate Inner Ring (2)	204-011-463-109	 2500 hours
Collective Lever-to-Swashplate Support (1)	20-057-8-92D	   2500 hours
Boost Tube-to-Universal (3)	20-057-5-24D	   2500 hours
Universal-to-Boost Cylinder (3)	20-057-5-24D	   2500 hours
Boost Cylinder-to-Lower Support (3)	212-001-323-001	   2500 hours
Rephasing Lever-to-Hub (4)	20-057-6-82D	  1250 hours
Rephasing Lever-to-Hub (4)	20-057-8-84D	   2500 hours
MAIN ROTOR SUPPLEMENTAL CONTROL SYSTEM BOLTS 		
Swashplate Inner Ring-to-R.H. Cyclic Boost (1)	20-057-5-24D	2500 hours
Swashplate Inner Ring-to-L.H. Cyclic Boost (1)	20-057-5-24D	2500 hours
Collective Lever-to-Collective Boost (1)	20-057-5-24D	2500 hours
PROPULSION AND DRIVE SYSTEM		
Planetary Spider	204-040-785-003	 On condition
Planetary Spider	412-040-785-101	2500 hours
Planetary Spider	412-040-785-103	 On condition
Main Rotor Mast Assembly	412-040-101-105	   10,000 hours or 80,000 RIN
Main Rotor Mast Assembly (used on helicopters with Mast Torque Systems)	412-040-101-121	   10,000 hours or 60,000 RIN
Main Rotor Mast Assembly	412-040-101-127	   10,000 hours or 80,000 RIN

Table 4-1. Airworthiness Limitations Schedule (Cont)





















NOMENCLATURE	PART NUMBER 	AIRWORTHINESS LIFE
PROPULSION AND DRIVE SYSTEM (CONT)		
Main Rotor Mast Assembly (used on helicopters with Mast Torque Systems)	412-040-101-129	   10,000 hours or 60,000 RIN
■ Main Rotor Mast Assembly (used on helicopters with Mast Torque Systems and with BHT-412-SI-62, Slope Landing Kit)	412-040-101-135	   5000 hours or 60,000 RIN
Main Rotor Mast Assembly	412-040-114-101	   2,500 hours or 25,000 RIN
■ Main Rotor Mast Assembly (used on helicopters with Mast Torque Systems and with BHT-412-SI-62, Slope Landing Kit)	412-704-012-105	   5000 hours or 60,000 RIN
Cap Retention	412-010-161-101	10,000 hours
Cap Retention	412-010-171-101	10,000 hours
Cap Retention	412-010-171-103	 10,000 hours
■ Mast Cap	412-010-171-105	5,000 hours
Cone	412-010-165-101	 10,000 hours
■ Cone	412-010-165-103	5,000 hours
Drive Pin	412-010-166-101	 10,000 hours
■ Drive Pin	412-010-166-103	5,000 hours
Upper Cone Seat	412-010-164-101	10,000 hours
Upper Cone Seat	412-010-174-101	10,000 hours
Upper Cone Seat	412-010-186-101	10,000 hours
■ Upper Cone Seat	412-010-186-107	5,000 hours
Upper Cone Seat	412-010-286-101	2,500 hours
Splined Plate Assembly	412-010-177-101	   Life limited (see notes)
Splined Plate Assembly	412-010-177-105	  10,000 hours or 60,000 RIN

Table 4-1. Airworthiness Limitations Schedule (Cont)





















NOMENCLATURE	PART NUMBER 	AIRWORTHINESS LIFE
PROPULSION AND DRIVE SYSTEM (CONT)		
Splined Plate Assembly	412-010-177-109	  10,000 hours or 80,000 RIN
Splined Plate Assembly	412-010-177-121	  5,000 hours or 60,000 RIN
Splined Plate Assembly	412-010-177-113	  10,000 hours or 60,000 RIN
Splined Plate Assembly	412-010-277-101	  2,500 hours or 25,000 RIN
Splined Plate Assembly	412-010-167-105	   Life limited (see notes)
Cone	412-010-169-103	10,000 hours
Cone	412-010-179-101	10,000 hours
Cone	412-010-179-105	 10,000 hours
Cone	412-010-179-107	5,000 hours
Lower Cone Seat	412-010-168-105	 10,000 hours
Lower Cone Seat	412-010-178-101	 10,000 hours
Lower Cone Seat	412-010-056-101	 2,500 hours
Lower Cone Seat	412-018-056-103	 10,000 hours
Lower Cone Seat	412-018-056-109	 5,000 hours
ELEVATOR AND CONTROLS		
Horn Assembly	205-001-914-103	 On condition
AIRFRAME		
Upper Aft Beam Cap	212-030-191-001	 On condition
TAIL ROTOR INSTALLATION		
Blade Assembly	212-010-750-009	5000 hours
Blade Assembly	412-016-100-111	5000 hours
Yoke Assembly	212-011-702-001	 5000 hours

Table 4-1. Airworthiness Limitations Schedule (Cont)

































NOMENCLATURE	PART NUMBER 	AIRWORTHINESS LIFE
LANDING GEAR		
High Aft Crosstube Assembly	412-050-011-101	   10,000 events
High Aft Crosstube Assembly	412-050-045-107	   20,000 events
High Aft Crosstube Assembly	412-321-104	   20,000 events
High Aft Crosstube Assembly	412-321-901	    12,000 events
FIRE EXTINGUISHER CARTRIDGES		
HTL Industries P/N 13083-5	209-062-908-015	  6 years service life/ 9 years total life
HTL Industries P/N 30900400	209-062-908-019	  6 years service life/ 9 years total life
W. Kidde and Co. P/N 804943	209-062-908-013	 6 years total life
W. Kidde and Co. P/N 804944	209-062-908-017	 6 years total life
W. Kidde and Co. P/N 895408-1	209-062-908-113	 10 years total life
W. Kidde and Co. P/N 895409-1	209-062-908-115	 10 years total life
FLOATS		
Float Hose	70-072M000C144	 6 years calendar life
Float Hose	70-072M000C222	 6 years calendar life
Float Hose	412-073-800-115A (uses hose P/N 70-072L000B204)	 6 years calendar life
Squib Cartridges, Floats	30908	  15 years total life
Squib Cartridges, Floats	29022968	  15 years total life
Cylinder Assembly, Floats	212-073-920-107	 10 years total life
INTERNAL HOIST KIT		
Cable Cutter Assembly (Squib)	1810-033-01	  5 years service life/ 10 years total life

Table 4-1. Airworthiness Limitations Schedule (Cont)
NOTES :

- 1 The airworthiness life or inspection interval for any part number contained in this schedule applies to all the successive dash numbers for that component unless it is otherwise specified.
- 2 In-service life begins the day the component is entered into service. In-service life only remains in effect while the component is installed on the helicopter.
- 3 Fail safe, refer to Chapter 5 for detailed 100-hour inspection.
- 4 On-condition subject to daily or 25-hour visual inspection interval (as applicable) per scheduled inspections (Chapter 5).
- 5 The bushing 412-010-222 is installed on the main rotor yoke assemblies 412-010-101-127/-129/-133 -135/-137/-139. The bushing is assigned an unlimited airworthiness life. If removed, it is not reusable.
- 6 An on-condition retirement is assigned to spider 204-040-785-003 subject to passing a magnetic particle inspection every 3100 hours per ASB 412-91-52A.
- 7 An additional 4 hours must be logged for each hoist operation performed within penalty CG region (Figure 4-1). Refer to Chapter 5 and BHT-412-FM.
- 8 RIN (Retirement Index Number) is the retirement life based on fatigue damage from normal helicopter lifts and takeoffs. New components will begin with an accumulated RIN of zero that will be increased as lifts and takeoffs are performed. Operators must record the number of lifts and takeoffs and increase the accumulated RIN accordingly. When the maximum RIN or retirement flight hours is/are reached, whichever occurs first, the component will be removed from service. Refer to Information Letter GEN-94-54/Information Letter GEN-03-94.
- 9 Retire when the part has 10,000 flight hours or when the accumulated RIN = 80,000, whichever occurs first. For manual tracking, increase the RIN count by 1 for each takeoff/lift recorded. If logging, increase RIN count by 2 for each lift recorded.
- 10 Retire when the part has 10,000 flight hours or when the accumulated RIN = 60,000, whichever occurs first. For manual tracking, increase the RIN count by 1 for each takeoff/lift recorded. If logging, increase RIN count by 2 for each lift recorded.
- 11 This splined plate assembly can be used on all 412 models. When used on 412 HP/EP, it will be vibroetched "412 HP" and will be retired when part has 10,000 flight hours or when the accumulated RIN = 60,000, whichever occurs first. For manual tracking, increase the RIN count by 1 for each takeoff/lift recorded. If logging, increase RIN count by 2 for each lift recorded (see Note 12).
- 12 This splined plate assembly can be used on all 412 models. When used on 412/412SP, it will not be vibroetched "412 HP". Retire when part has 10,000 flight hours or when the accumulated RIN = 80,000, whichever occurs first. For manual tracking, increase the RIN count by 1 for each takeoff/lift recorded. If logging, increase RIN count by 2 for each lift recorded (see Note 11).
- 13 Deleted.
- 14 Retire when the part has 5000 flight hours or when the accumulated RIN = 60,000, whichever occurs first. For manual tracking, increase the RIN count by 1 for each takeoff/lift recorded. If logging, increase RIN count by 2 for each lift recorded.

Table 4-1. Airworthiness Limitations Schedule (Cont)

NOTES (CONT):

- ▲¹⁵ Per ASB 412-99-97.
- ▲¹⁶ Contained in inflation valve 30905. 30908 includes squib 94455 and o-ring 568-905.
- ▲¹⁷ Per ASB 412-96-89, the tail rotor flapping stop/yield indicator 212-011-713-103 must be used with the tail rotor yoke. The stop/yield indicator 212-011-713-103 must be inspected every 25 hours and at each incident involving a hard landing, sudden stoppage, or any other incident involving excessive tail rotor flapping. Refer to Chapter 5.
- ▲¹⁸ Manufactured by Aeronautical Accessories, Inc. Refer to AAI Report No. ICA AA-01136 Rev. C, or subsequent, Inspection and Maintenance Instructions. Recurring visual inspection per AAI Bulletin AA-07109 and ASB 412-08-129.
- ▲¹⁹ As per ASB 412-98-92, bolt 20-057-5-25D is replaced by 20-057-5-28D.
- ▲²⁰ Total life begins from the date of component manufacture and cannot be interrupted.
- ▲²¹ Calendar life begins the day the component is entered into service and cannot be interrupted.
- ▲²² Not applicable to subsequent dash numbers.
- ▲²³ Deleted.
- ▲²⁴ Replacement bearing cartridges 412-310-400-107 are on-condition. Refer to IL 412-IL-03-49.
- ▲²⁵ As per ASB 412-02-110, bolt 204-011-463-001 is replaced by 204-011-463-109.
- ▲²⁶ 29022968 contained in valve assembly 20022988 Rev. E and refurbishment kit 29022971.
- ▲²⁷ As per ASB 412-93-73, bolt 412-010-124-105 is replaced by 412-010-124-109.
- ▲²⁸ Included in bolt kit 412-704-112-101. Bolt kit 412-704-112-101 is replaced by bolt kit 412-704-112-105.
- ▲²⁹ Included in bolt kit 412-704-112-103. Bolt kit 412-704-112-103 is replaced by bolt kit 412-704-112-105.
- ▲³⁰ Included in bolt kit 412-704-112-105.
- ▲³¹ Not included in bolt kits 412-704-112-101/-103/-105.
- ▲³² Life reduction to 2500 hours per ASB 412-08-131; remove from service by 1 June 2009.
- ▲³³ Refer to ASB 412-08-128.
- ▲³⁴ Use aft crosstube retention strap kit per BHT-412-SI-58 when towing helicopters with a gross weight of 8900 pounds or greater.
- ▲³⁵ Swashplate support assembly 412-010-443-101 was removed from service by ASB 412-93-71. All subsequent dash numbers remain in service.
- ▲³⁶ Swashplate support assembly 412-010-409-105 was removed from service by ASB 412-93-71.

**Table 4-1. Airworthiness Limitations Schedule (Cont)****NOTES (CONT):**

- △₃₇ Swashplate support assembly 412-010-453-101 was removed from service by ASB 412-92-61. All subsequent dash numbers remain in service.
- △₃₈ 500-hour penalty to be applied in accordance with AD 99-23-23 and ASB 412-98-93.
- △₃₉ AD 2012-22-11 imposes on collective lever 412-010-408-101 a visual inspection at intervals not to exceed 100 hours Time-In-Service (TIS) (ASB 412-11-148 Rev. A).
- △₄₀ Visual inspection at intervals not to exceed 100 hours Time-In-Service (TIS). Inspection requirements same as listed in ASB 412-11-148 Rev. A.
- △₄₁ AD 2000-18-09 imposes on the upper aft beam cap 212-030-191-001 a recurring visual inspection at intervals not to exceed 100 hours Time-In-Service (TIS) (ASB 412-00-100). All aircraft with serial numbers 38001–38999 and 39101–39999 require a visual inspection in intervals not to exceed 50 hours Time-In-Service (TIS). Refer to AD 2000-18-09 for inspection procedures.
- △₄₂ For manual tracking, increase the event count by 1 for each takeoff recorded.
- △₄₃ Part manufactured and part number assigned by AAI of Bristol, Tennessee. Retire part when event = 12,000 (event life).
- △₄₄ 1000-event penalty to be applied against accumulated events of high aft crosstube assembly if used with increased gross weight kit 412-706-140 (BHT-412-FMS-74.5). 1000 event penalty to be applied on high aft crosstube assembly 412-321-901 on all aircraft serial numbers 38001–38999 and 39101–39999.
- △₄₅ On Condition indicates that there is no retirement life (i.e., unlimited). Any required inspections will be addressed by additional specific notes.
- △₄₆ Retire when the part has 2,500 flight hours or when the accumulated RIN is 25,000, whichever occurs first. For manual tracking, increase the RIN count by 1 for each takeoff/lift recorded. If logging, increase RIN count by 2 for each lift recorded.
- △₄₇ Apply a one time 7,500 hours penalty for all aircraft with serial numbers 38001–38999 and 39101–39999 on retention cap, cones, and drive pins.

NOTE: The pilot must record each hoist operation performed within penalty region (Refer to BHT-412 FM).

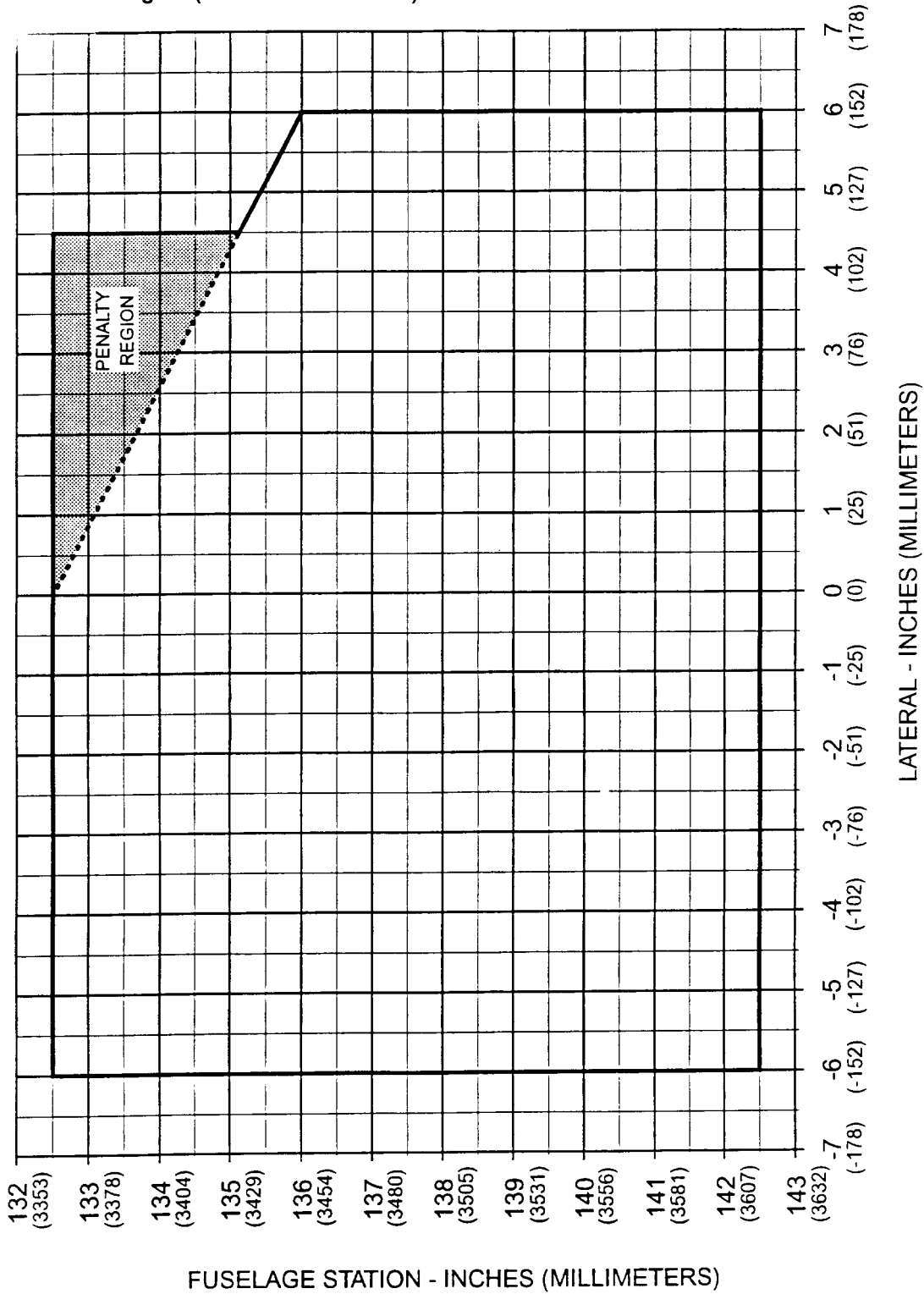

412MM_04000_00010_001_C00

Figure 4-1. Longitudinal/Lateral CG Envelope for Hoist Operations



CHAPTER 5 — INSPECTIONS

TABLE OF CONTENTS

Paragraph Number	Title	Chapter/Section Number	Page Number
INSPECTIONS			
5-1	General	5-00-00	5
5-2	Inspection Requirements	5-00-00	6
5-3	Crash Damage.....	5-00-00	6
5-4	Types of Inspections	5-00-00	7
5-5	Definitions	5-00-00	8
5-6	Inspection and Overhaul Tolerance	5-00-00	8
SCHEDULED INSPECTIONS			
5-7	Scheduled Inspections.....	5-00-00	11
5-8	Daily Inspection — Part A.....	5-00-00	13
5-9	100 Hour/12 Month Inspection — Part A	5-00-00	31
5-10	1000 Hour Inspection — Part A	5-00-00	55
5-11	5000 Hour/5 Year Inspection — Part A.....	5-00-00	57
5-12	25 Hour/30 Day Inspection — Part B.....	5-00-00	67
5-13	300 Hour/12 Month Inspection — Part B	5-00-00	91
5-14	600 Hour/12 Month Inspection — Part B	5-00-00	107
5-15	5000 Hour/5 Year Inspection — Part B.....	5-00-00	115
SPECIAL INSPECTIONS			
5-16	Special Inspection.....	5-00-00	125
5-17	Daily/10 Hour Inspection, Whichever Occurs First Until 250 Hours	5-00-00	127
5-18	Between 1 and 5 Flight Hours After Main Rotor Hub Installation...	5-00-00	131
5-19	Between 1 and 25 Flight Hours After Expandable Blade Bolt Installation.....	5-00-00	133
5-20	Between 5 and 10 Hours of Flight After Each Installation.....	5-00-00	135
5-21	Each 25 Hours for the Next Four Inspections	5-00-00	137
5-22	Each 25 Hours of Tail Rotor Operation.....	5-00-00	139
5-23	50 Hours After Installation of Components	5-00-00	143
5-24	100 Hours After Installation of Tailboom.....	5-00-00	145
5-24A	Each 100 Hours Tailboom Attachment Inspection.....	5-00-00	146A
5-24B	Each 100 Hours Tailboom Vertical Fin Spar Cap Inspection.....	5-00-00	146C
5-25	Each 100 Hours of Collective Lever Operation.....	5-00-00	147
5-26	Each 150 Hours of Starter Generator (200SG119Q) Operation	5-00-00	151
5-27	Each 300 Hours or 6 Months of Expandable Blade Bolt Operation	5-00-00	153
5-28	Each 600 Hours of Tail Rotor Driveshaft Operation or 12 Months	5-00-00	157
5-29	Each 600 Hours of Main Driveshaft Operation or 12 Months	5-00-00	161
5-29A	Each 600 Hours or 12 Months Inspection of Magnetic Brake Assembly	5-00-00	162A
5-30	Each 1000 Hours of Component Operation.....	5-00-00	163



TABLE OF CONTENTS (CONT)

Paragraph Number	Title	Chapter/Section Number	Page Number
5-31	Each 12 Months or 2500 Landings of Aft High Crosstube Operation	5-00-00	165
5-32	Each 24 Months of Control Bolt Operation	5-00-00	173
5-33	Each 24 Months Of Main Rotor Mast Operation	5-00-00	177
5-34	Each 2500 Hours of Main Rotor Hub Assembly Operation.....	5-00-00	179
5-35	Each 2500 Hours of Main Rotor Blade Operation.....	5-00-00	181
5-36	Each 2500 or 3000 Hours or 5 Years of Main Rotor Mast (412-040-366-109 and Subsequent) Operation	5-00-00	183
5-37	Each 2500 Hours of Tail Rotor Drive System Operation	5-00-00	187
5-38	Each 3000 Hours or 5 Years of Main Rotor Mast (412-040-366-103 and -105) Operation	5-00-00	197
5-39	Each 3000 Hours of Transmission (412-040-002) Operation	5-00-00	201
5-40	Each 3000 Hours of Transmission (412-040-004/412-040-007/412-040-802) Operation.....	5-00-00	205
5-41	3600 Hours Total Airframe Time and Each 300 Hours/12 Months Inspection	5-00-00	213
5-42	Each 3000 Hours or 5 Years of Transmission Mount Assembly (204-031-927) and Friction Damper Assembly (204-031-920) Operation.....	5-00-00	215
5-43	Each 10 Years Collective Stick Tube Inspection	5-00-00	217

CONDITIONAL INSPECTIONS

5-44	Conditional Inspection.....	5-00-00	219
5-45	After Hard Landing.....	5-00-00	221
5-46	Sudden Stoppage — Power On or Off.....	5-00-00	227
5-47	After Overspeed.....	5-00-00	237
5-48	After Overtorque	5-00-00	241
5-49	After Compressor Stall or Surge	5-00-00	247
5-50	After Lightning Strikes.....	5-00-00	253
5-51	After Engine Combining Gearbox Clutch Non-engagement, Misengagement, or In-flight Slippage	5-00-00	259

COMPONENT OVERHAUL SCHEDULE

5-52	Component Overhaul Schedule.....	5-00-00	267
------	----------------------------------	---------	-----

FIGURES

Figure Number	Title	Page Number
5-1	Deleted.....	65
5-2	Cabin Frame Inspection — Part A	66
5-3	Deleted.....	123
5-4	Cabin Frame Inspection — Part B	124
5-5	Tail Rotor Blade — Special Inspection	141
5-5A	Vertical Fin Spar Cap – Special Inspection.....	146D
5-6	Collective Lever — Special Inspection.....	149



FIGURES

Figure Number	Title	Page Number
5-7	Expandable Blade Bolt — Special Inspection.....	156
5-8	Aft High Crosstube — Special Inspection	171
5-9	Collective Stick Tube — Special Inspection.....	218
5-10	Fuselage Tailboom Attachment Inspection.....	263
5-11	Spiral Bevel Gear Inspection	264

TABLES

Table Number	Title	Page Number
5-1	Component Overhaul Schedule.....	268

INSPECTIONS

5-1. GENERAL

This chapter contains the requirements for Scheduled, Special, and Conditional Inspections, and a Component Overhaul Schedule.

WARNING

FAILURE TO CORRECT CONDITIONS SUCH AS, BUT NOT LIMITED TO, CORROSION, EROSION, MECHANICAL DAMAGE, OR OBVIOUS WEAR FOUND DURING A SCHEDULED INSPECTION COULD SERIOUSLY AFFECT THE AIRWORTHINESS OF THE HELICOPTER.

These inspection requirements constitute an approved inspection program designed and recommended by Bell Helicopter Textron for the Model 412 Series. They can be utilized by registered owners or operators who desire to develop a progressive inspection system to be used as part of the complete maintenance program. A written request for approval to use the progressive inspection system shall be submitted to the governing civil aviation authority having jurisdiction over the area in which the owner or operator is located. Relief from the requirements in this chapter can be requested through the local aviation authority. For the convenience of the operator, two separate scheduled inspections are provided as follows:

- Part A Scheduled inspections consist of a daily inspection, 100 hour/12 calendar month inspection, 1000 hour inspection, and 5000 hour/5 year inspection.
- Part B Scheduled inspections consist of a 25 hour/30 day inspection, 300 hour/12 month, 600 hour/12 month inspection, and 5000 hour/5 year inspection.

Either series of inspections may be utilized. However, once a helicopter has been started on either inspection program, it shall be maintained on that program except as follows:

- If a helicopter is being inspected on the Part A inspection program and it is desired to change

to the Part B inspection program, a complete Part A 1000 hour inspection shall be accomplished. The helicopter may then be changed to the Part B inspection program beginning with a 25 hour/30 day inspection.

- If a helicopter is being inspected on the Part B inspection program and it is desired to change to the Part A inspection program, a complete 600 hour inspection shall be accomplished. The helicopter may then be changed to the Part A inspection program beginning with a daily inspection.

The inspection intervals given in this chapter are the maximum permitted. Do not exceed these intervals. The owner/operator is responsible for increasing the scope and the frequency of the inspections as necessary. Make sure the helicopter is maintained safely during all unusual local changes, such as environmental conditions, helicopter use, etc. You can request changes to the requirements in this chapter through the local aviation authority.

The inspection intervals and the component overhaul schedule provided in this chapter are applicable only to Bell Helicopter Textron approved parts.

NOTE

The time period given for the overhaul of a component (or the failure to give a time period for the overhaul of a component) does not constitute a warranty of any kind. The only warranty applicable to the helicopter or any component is the warranty included in the Purchase Agreement for the helicopter or the component.

The Time Between Overhaul (TBO) and the inspection periods are determined through experience, tests, Lead The Fleet (LTF), or any other special programs and the judgement of Bell Helicopter Textron engineers. They are subject to change only by Bell Helicopter Textron or an approved Airworthiness Authority.

Changes to the TBO will be introduced by either revisions to this chapter or a Technical Bulletin.

Every calendar and hourly inspection is a thorough visual inspection to determine the airworthiness of the helicopter and the components. Qualified persons must do the inspections in accordance with quality standard aircraft practices and the applicable maintenance manuals. Bell Helicopter Textron considers that it is mandatory to obey all the applicable Alert Service Bulletins (ASB) and the Airworthiness Directives (AD).

Component operating time records are necessary for components that have scheduled maintenance procedures, which are different from those of the airframe. It is the owner/operator's responsibility to keep the Historical Service Records (HSR) for the applicable component and to do the necessary maintenance procedures.

Before each inspection, remove or open the necessary cowlings, fairing, inspection doors, and panels.

5-2. INSPECTION REQUIREMENTS

This manual does not include specific inspections required by the FAA or other government regulatory authorities. These specific inspections are given by your government regulatory authority. Refer to their requirements for these specific inspections.

The owner/operator of the helicopter is responsible for the maintenance done on the helicopter. It is the owner/operator's responsibility to:

1. Establish, maintain, and review the log books for discrepancies.
2. Make sure the Alert Service Bulletins (ASB), the Airworthiness Directives (AD), and the special inspections are done when they are required to be done.
3. Make sure the scheduled inspections, the special inspections, and the required tests for all of the installed kits are complied with.
4. Make sure all parts and components for which Historical Service Records are required have documented traceability to their original installation in the helicopter.

WARNING

ALL PARTS REMOVED, DUE TO REACHING THEIR LIMITS OR AS A RESULT OF AN ACCIDENT/INCIDENT INSPECTION AND DEEMED UNAIRWORTHY, SHALL BE PERMANENTLY MARKED AS SCRAP OR PHYSICALLY DESTROYED TO THE EXTENT THAT THERE IS NO CHANCE OF REPAIR OR INSTALLATION ON ANY HELICOPTER OR COMPONENT.

5. Make sure all limited life parts that have completed their published operating limits are replaced.
6. Make sure all of the components that have completed their published overhaul periods are overhauled.
7. Make sure all of the maintenance that is done on the helicopter is done by an approved maintenance organization.

The maintenance organization/person doing the maintenance is responsible for the quality of the maintenance done.

The owner/operator may choose to ask the maintenance organization/person doing the maintenance to perform the tasks listed by prior arrangement through a separate formal agreement.

5-3. CRASH DAMAGE

Because of the many possible combinations that can result from crash damage, it is not possible to include the specific repair tasks in this category. The helicopter mechanic must make an analysis of the crash damage for each situation. Do the repair in accordance with the degree of damage to the specific part and the applicable repair procedures in this manual. Call Product Support Engineering with your analysis of the crash damage.

5-4. TYPES OF INSPECTIONS

1. The maintenance procedures may include scheduled inspections, special inspections, conditional inspections, component interim inspections, and component overhaul inspections.

a. Scheduled inspections must occur at specified operating intervals. The intervals may be in operating time (hours), cycles, torque events (RIN), calendar (days, months, years) or other assigned units. This ensures the helicopter is airworthy.

- Scheduled inspections — Part A consists of:
 - Daily inspection — Accomplish daily before flight operation.
 - 100 hours/12 calendar months — Accomplish each 100 hours of flight operation or 12 calendar months, whichever comes first.
 - 1000 hours — Accomplish each 1000 hours of flight operation.
 - 5000 hours/5 years — Accomplish each 5000 hours of flight operation or each 60 calendar months, whichever comes first.
- Scheduled inspections — Part B consists of the following:
 - 25 hours/30 days — Accomplish each 25 hours of flight operation or each 30 days, whichever comes first.
 - 300 hours/12 month inspection — Accomplish each 300 hours of flight operation or each 12 calendar months, whichever comes first.
 - 600 hours/12 months — Accomplish each 600 hours of flight operation or each 12 calendar months, whichever comes first.
 - 5000 hours/5 years — Accomplish each 5000 hours of flight operation or each 60 calendar months, whichever comes first.

b. Special inspections are of a temporary nature or of a special interval that is not consistent with the scheduled inspections.

c. Conditional inspections do not occur at a specified time. A conditional inspection is the result of known or suspected unusual event, known or suspected malfunctions, or defects.

d. An interim inspection occurs between overhauls.

e. The component overhaul schedule gives the elapsed operating time at which a component must be removed, disassembled, examined for condition, and overhauled, in accordance with data approved by Bell Helicopter Textron.

2. Airworthiness limitations — Replace components in accordance with Airworthiness Limitations Schedule (Chapter 4).

3. Lubrication and servicing requirements are in addition to those stated in this chapter (Chapter 12).

4. For corrosion control, refer to the Corrosion Control Guide, CSSD-PSE-87-001 and the BHT-ALL-SPM.

5. For the PT6T Series engines, refer to the applicable Pratt & Whitney Canada Engine Maintenance Manual for the scheduled inspections, special inspections, conditional inspections, and component overhaul schedule.

6. For the common Bell Helicopter Textron approved optional equipment that is integrated into this maintenance manual, refer to this chapter for the scheduled inspection, conditional inspection, component interim inspection, and component overhaul inspection.

7. For all other Bell Helicopter Textron approved equipment, refer to the applicable Service Instruction for the scheduled inspection, special inspection, conditional inspection, component interim inspection, and component overhaul inspection.

8. For the inspection requirements for optional equipment approved under Supplement Type Certificate (STC), refer to the applicable STC documentation. Maintenance and inspection of these items are the responsibility of the owner/operator.



5-5. DEFINITIONS

- Inspect, check, examine — Determine condition relative to an established standard.
- Condition — The state of being of an item as related to serviceable or unserviceable standard.
- Security — The presence of attaching parts that are properly tightened or appear to be, and the presence of properly installed (as required) locking devices such as lockwire, cotter pins, or other.
- Standard — An established rule or measure to determine condition.
- Damage — Physical deterioration whereby the standard renders the condition or an item acceptable or not acceptable for continuous use.
- Discard — Reject a component that has damage that cannot be repaired. To permanently remove from service.
- Preventive maintenance — Simple or minor preservation and the replacement of small standard parts not involving complex assembly operations.
- Maintenance — Inspection, overhaul, repair, preservation, and the replacement of parts, but excludes preventive maintenance.
- Operating time — Time required to be recorded in historical record sheets or helicopter logs. Operating time to be recorded may be identified as follows:
 - Time in service — Time from the moment a helicopter leaves the surface of the earth until it touches down at the next point of landing. Time during which the engine and rotor are turning with the helicopter on the ground is not taken into account.
 - Calendar time — Elapse time starts the day the inspection is accomplished, the component is installed, or the rotor is turned for the first time and ends on the last day of the month that the time limit expires. Calendar time shall be recorded without interruption.

Removal of the component or storage of the helicopter etc. does not stop calendar time.

- Planned event — Occurrence of interval in which a specific action is to be taken as in the case of preventive maintenance, scheduled overhaul, or replacement in accordance with maximum airworthiness life guidelines.
- Lead The Fleet (LTF) Program — This is a program to validate the performance of an approved product improvement or a change to a maintenance interval. The engineering aspects of this change are approved. The program is closely monitored by Bell Helicopter Textron in an operational environment with selected operators.
- Special Programs — These are approved programs that may be initiated under certain special conditions to meet specific requirements. These programs will be clearly defined through a plan and the engineering and maintenance aspects will be approved by the regulatory authorities.

5-6. INSPECTION AND OVERHAUL TOLERANCE

WARNING

DO NOT APPLY THESE TOLERANCES TO PARTS WITH A LIMITED AIRWORTHINESS LIFE OR PARTS SUBJECT TO AN INSPECTION LISTED IN THE AIRWORTHINESS LIMITATION SCHEDULE (CHAPTER 4).

The Bell Helicopter Textron approved tolerance for scheduled inspections, special inspections, interim inspections, and overhaul intervals, unless otherwise stated, is 10% or up to a maximum of 300 hours operating time/6 months calendar time, whichever is less. The tolerances are established for maintenance scheduling convenience only.

Scheduled inspections, special inspections, interim inspections, or overhaul intervals required beyond the stated tolerances must be approved by Product Support Engineering.

NOTE

The following is only applicable for those operators whose governing aviation authority requires to specifically approve the inspection and overhaul tolerance.

If approval of the inspection and overhaul tolerance is required by the applicable governing aviation authority, this is the responsibility of the owner/operator.

Refer to the applicable Pratt & Whitney Canada Engine Maintenance Manual for inspection and overhaul tolerances.

The following provides examples of when hourly, calendar, or hourly/calendar inspection tolerances have been applied:

Hourly Example (10% or up to a maximum of 100 hours, whichever is less):

300-HOUR INSPECTION DUE AT:	MAXIMUM ALLOWED TOLERANCE	INSPECTION CARRIED OUT AT:	NEXT 300-HOUR INSPECTION DUE AT:
3400 Hours	10% of 300 hours = 30 hours	3430 Hours (10% tolerance applied)	3730 Hours
3730 Hours	10% of 300 hours = 30 hours	3750 Hours (within 10% tolerance)	4050 Hours
4050 Hours	10% of 300 hours = 30 hours	4050 Hours (tolerance not applied)	4350 Hours

Calendar Example (10% or up to a maximum of 30 days calendar time, whichever is less):

12-MONTH INSPECTION DUE ON:	MAXIMUM ALLOWED TOLERANCE	INSPECTION CARRIED OUT ON:	NEXT 12-MONTH INSPECTION DUE ON:
June 10, 2010	10% of 12 months = 1.2 months (maximum allowed is 30 days)	July 8, 2010 (within 30 day tolerance)	July 31, 2011 [△] ₁
July 31, 2011	10% of 12 months = 1.2 months (maximum allowed is 30 days)	June 15, 2011 (completed early)	June 30, 2012 [△] ₁
June 30, 2012	10% of 12 months = 1.2 months (maximum allowed is 30 days)	June 30, 2012 (tolerance not applied)	June 30, 2013 [△] ₁

NOTE:

[△]₁ The last day of the month applies for the next inspection (paragraph 5-5, calendar time). For inspection intervals that are measured in days rather than months, the calendar time ends on the day that the time limit expires on, not the end of the month.

Hourly/Calendar Example (10% or up to a maximum of 100 hours operating time/30 days calendar time, whichever is less):

5000-HOUR/ 5 YEAR INSPECTION DUE AT:	MAXIMUM ALLOWED TOLERANCE	INSPECTION CARRIED OUT AT:	NEXT 5000-HOUR/ 5 YEAR INSPECTION DUE AT:
6000 Hours/ December 31, 2010	10% of 5000 hours = 500 hours (maximum allowed is 100 hours) or 10% of 60 months = 6 months (maximum allowed is 30 days)	6000 Hours/January 15, 2011 (within 30 day calendar tolerance)	11,000 Hours/ January 31, 2016 ¹
11,000 Hours/ January 31, 2016	10% of 5000 hours = 500 hours (maximum allowed is 100 hours) or 10% of 60 months = 6 months (maximum allowed is 30 days)	11,100 Hours/January 2, 2016 (100 hour tolerance applied)	16,100 Hours/ January 31, 2021 ¹
16,100 Hours/ January 31, 2021	10% of 5000 hours = 500 hours (maximum allowed is 100 hours) or 10% of 60 months = 6 months (maximum allowed is 30 days)	16,175 Hours/February 20, 2021 (within 100 hour and 30 day calendar tolerance)	21,175 Hours/ February 28, 2026 ¹

NOTE:

¹ The last day of the month applies for the next inspection ([paragraph 5-5](#), calendar time). For inspection intervals that are measured in days rather than months, the calendar time ends on the day that the time limit expires on, not the end of the month.

SCHEDULED INSPECTIONS

5-7. SCHEDULED INSPECTIONS

Part A — Inspect helicopter daily, each 100 hours/
12 months, each 1000 hours, each 5000 hours/
5 years.

Part B — Inspect helicopter each 25 hours/30 days,
each 300 hours/12 months, each 600 hours/
12 months, each 5000 hours/5 years.

SCHEDULED INSPECTIONS

5-8. DAILY INSPECTION — PART A

DATA REFERENCE	INSPECTION TASK DESCRIPTION	INITIAL	
		MECH	OTHER
	<p>DATE: _____ W.O. _____</p> <p>FACILITY: _____</p> <p>HELICOPTER S/N: _____</p> <p>REGISTRY NO.: _____</p> <p>TOTAL TIME: _____</p> <p>SIGNATURE: _____</p> <p style="text-align: center;">NOTE</p> <p>For helicopters on the Part A inspection program, accomplish the following checks daily before flight operation.</p> <p><u>GENERAL</u></p> <p>1. Each listed inspection item or maintenance function is to be performed in accordance with the BHT-412-MM chapter specified or the BHT-412-CR&O.</p> <p>2. Refer to the applicable Pratt & Whitney Canada Engine Maintenance Manual for engine inspection requirements.</p> <p><u>PRELIMINARY REQUIREMENTS</u></p> <p>1. Use medium helicopter corrosion control guide to establish helicopter corrosion control program.</p> <p>2. Replace all finite life components that have completed published operating limitations.</p> <p>3. Overhaul all components that have completed published overhaul periods.</p> <p>4. Lubricate and service helicopter as required.</p>		
Corrosion Control Guide, CSSD-PSE-87-001.			
Chapter 4			
Chapter 5			
Chapter 12			

SCHEDULED INSPECTIONS

5-8. DAILY INSPECTION — PART A (CONT)

DATA REFERENCE	INSPECTION TASK DESCRIPTION	INITIAL	
		MECH	OTHER
Chapter 5	<p>5. Review Special Inspections and carry out applicable inspections.</p> <p>6. Examine all inspection windows and sight glasses for cracking, crazing, and discoloration. If any of these conditions are present, the part must be removed and replaced prior to returning helicopter for service.</p>		
Service Instruction (SI)	<p>7. Ensure all required inspections of installed BHT kits not covered in this inspection have been performed, as applicable.</p>		
Chapter 21	<p><u>BLEED AIR HEATING SYSTEM COMPONENTS</u></p> <p>1. Visually inspect heater compartment for cleanliness, condition, and security of heating system components, wiring, ducts, supports, and structure for damage and corrosion.</p> <p>2. Visually inspect overhead ventilating system components for condition and security.</p> <p>3. Visually inspect heat/vent air ducts for condition and security.</p> <p>4. Visually inspect ventilation/defog components for condition and security.</p>		
Chapter 25	<p><u>CREW/PASSENGERS SEATS</u></p> <p>1. Visually inspect crew seats for condition, security, and operation.</p> <p>2. Visually inspect crew seats restraints for condition, security, and operation.</p> <p>3. Crew seat attenuator for compression — inspect witness line. If line is not visible, repair attenuator assembly.</p> <p>4. Visually inspect passenger seats for condition and security.</p> <p>5. Visually inspect passenger seats restraints for condition and security.</p>		

SCHEDULED INSPECTIONS

5-8. DAILY INSPECTION — PART A (CONT)

DATA REFERENCE	INSPECTION TASK DESCRIPTION	INITIAL	
		MECH	OTHER
Chapter 25	<p><u>MISCELLANEOUS FURNISHINGS</u></p> <p>Visually inspect miscellaneous furnishing (map and data case, first aid kit, and emergency equipment) for condition and security.</p>		
Chapter 26	<p><u>FIRE EXTINGUISHERS</u></p> <p>Visually inspect cockpit and cabin portable fire extinguishers and engine compartment fire extinguishers containers for security and condition.</p>		
Chapter 28	<p><u>FUEL SYSTEM</u></p> <p>Visually inspect fuel samples for contamination.</p>		
Chapter 29	<p><u>HYDRAULIC SYSTEMS</u></p> <p>1. Visually inspect the following:</p> <ul style="list-style-type: none"> a. Hydraulic system 1 and 2 filter bypass indicator buttons — not extended. b. Collective and cyclic servo actuators and boost tubes for leaks, damage, and security. c. Hydraulic system 1 and 2 pumps for leaks, damage, and security. d. Hydraulic system 1 and 2 valve and filter modules for leaks, damage, and security. e. Hydraulic system 1 and 2 lines, hoses, and fittings for leaks, damage, chafing, kinking, and security. f. Hydraulic system 1 and 2 reservoirs for proper fluid levels, damage, corrosion, and security. g. Tail rotor hydraulic actuator and hoses for leakage, corrosion, and security. <p>2. Remote hydraulic filter bypass indicator (located in right nose window) — confirm not tripped.</p>		

SCHEDULED INSPECTIONS

5-8. DAILY INSPECTION — PART A (CONT)

DATA REFERENCE	INSPECTION TASK DESCRIPTION	INITIAL	
		MECH	OTHER
Chapter 30	<p><u>WINDSHIELD WIPER</u></p> <p>Visually inspect windshield wiper blades for serviceability and security.</p>		
Chapter 32	<p><u>LANDING GEAR SYSTEM</u></p> <p>1. Visually inspect landing gear as follows:</p> <p style="padding-left: 40px;">a. Forward crosstube and cap fittings for condition and security of attachment.</p> <p style="padding-left: 40px;">b. Aft crosstube, cap fittings, and wear strips for condition and security of attachment.</p> <p style="padding-left: 40px;">c. Aft crosstube support beam for wear, cracks, damage, corrosion, and security of attachment.</p> <p style="padding-left: 40px;">d. Skid tubes and skid shoes for condition and security of attachment. Replace skid shoes that are worn into shoe surface. Repair weld beads as required.</p> <p style="padding-left: 40px;">e. Fuselage supports for wear, damage, and security of attachment.</p> <p style="padding-left: 40px;">f. If installed, landing gear forward crosstube crew step fittings for corrosion, damage, and security in area of attachment. If edge sealant is damaged or missing, remove crew step and inspect crosstube for corrosion or damage.</p> <p style="padding-left: 40px;">g. Emergency float reservoir pressure indicator for proper charge indication (if installed).</p> <p style="padding-left: 40px;">h. Floats for proper stowage and condition (if installed).</p> <p>2. Visually inspect tail skid for deformation and security of attachment.</p>		

SCHEDULED INSPECTIONS

5-8. DAILY INSPECTION — PART A (CONT)

DATA REFERENCE	INSPECTION TASK DESCRIPTION	INITIAL	
		MECH	OTHER
Chapter 52	<p><u>DOORS, WINDOWS, AND EMERGENCY EXIT</u></p> <ol style="list-style-type: none"> 1. Visually inspect nose door for obvious damage, security of attachment, proper latching, and seal for condition. 2. Visually inspect all windows for damage. Crew door windows, cargo hinged door window, passenger sliding door windows, cabin roof windows, cabin lower nose windows, and windshields. 3. Visually inspect crew door emergency release pins for security. 4. Visually inspect cabin doors for condition, security, and freedom of operation. 5. Avionics/electrical and heater compartment doors for condition and security of attachment. Latches for proper operation. 		
Chapter 53	<p><u>FUSELAGE</u></p> <ol style="list-style-type: none"> 1. Visually inspect fuselage exterior for condition and damage to protective finish. 2. Visually inspect fuselage underside for evidence of fuel and hydraulic fluid leakage 3. Visually inspect all cowlings and fairings for condition and security, missing fasteners, cracks, and proper operation of latches. 4. Inspect fuselage tailboom attachment points for security. 5. Visually inspect pitot tubes and static ports for obstruction and damage. 		

SCHEDULED INSPECTIONS

5-8. DAILY INSPECTION — PART A (CONT)

DATA REFERENCE	INSPECTION TASK DESCRIPTION	INITIAL	
		MECH	OTHER
	<p>6. Visually inspect fuselage interior for evidence of water entrapment in following areas:</p> <ul style="list-style-type: none"> a. Nose compartment b. Pilot and passenger cabin c. Electrical compartment d. Heater compartment e. Baggage compartment 		
Chapter 53	<p><u>TAILBOOM</u></p> <p>1. Inspect tailboom exterior structure for general condition.</p>		
Chapter 52	<p>2. Inspect baggage compartment interior for condition and cleanliness.</p> <p>3. Check baggage compartment door for damage, proper operation, and security.</p> <p>4. Inspect driveshaft and intermediate gearbox covers for damage and security.</p>		
Chapter 62	<p><u>MAIN ROTOR BLADES</u></p> <p>Visually inspect main rotor blades for condition, damage, security, and cleanliness.</p>		
Chapter 62	<p><u>MAIN ROTOR HUB</u></p> <p>1. Visually inspect main rotor hub assembly for condition and security, paying particular attention to the condition of elastomeric components, and the integrity of sealing.</p> <p>2. Visually inspect pitch horns for condition, security, and cracks in areas surrounding torque transfer pin holes. No cracks permitted.</p> <p>3. Inspect pivot bearings and damper yoke set for elastomeric bearing delamination, cracking, and elastomer degradation.</p>		

SCHEDULED INSPECTIONS

5-8. DAILY INSPECTION — PART A (CONT)

DATA REFERENCE	INSPECTION TASK DESCRIPTION	INITIAL	
		MECH	OTHER
Chapter 62	<p><u>MAIN ROTOR CONTROLS</u></p> <ol style="list-style-type: none"> 1. Visually inspect swashplate and support assembly and collective lever for condition and security. 2. Visually inspect hub and sleeve assembly for condition and security. <p style="text-align: center;">NOTE</p> <p style="text-align: center;">Use swashplate link and drive link bearings — Work aid (Chapter 62) to assist with determining condition of main rotor control bearings.</p> <ol style="list-style-type: none"> 3. Visually inspect drive hub and rephasing levers for bearing looseness and security of attachment. 4. Visually inspect pitch links for condition, security, and bearing looseness. 5. Visually inspect mast assembly for corrosion and mechanical damage. Mast seal for leakage. 		
Chapter 63	<p><u>ENGINE-TO-TRANSMISSION (MAIN) DRIVESHAFT</u></p> <ol style="list-style-type: none"> 1. Visually inspect main driveshaft for condition and security. <div style="text-align: center; margin: 10px 0;">  <p>WARNING</p> </div> <p style="text-align: center;">CAUSE OF ANY DISCOLORATION SHALL BE DETERMINED AND CORRECTED PRIOR TO NEXT FLIGHT.</p>		

SCHEDULED INSPECTIONS

5-8. DAILY INSPECTION — PART A (CONT)

DATA REFERENCE	INSPECTION TASK DESCRIPTION	INITIAL	
		MECH	OTHER
Chapter 63	<p>2. Visually inspect main driveshaft forward and aft couplings, boots, seals (and surrounding area), for grease leakage, damage, corrosion, and evidence of overheat as indicated by TEMP-PLATES or coupling discoloration. A change in color of any yellow bordered TEMP-PLATE, from white/off-white to black, will indicate a possible overheat condition and/or component degradation (step 3). If one of more of the red bordered TEMP-PLATE dots change from white/off-white to black, an overheat condition is present and may require replacement of both outer and inner couplings.</p> <p>3. Visually inspect overheat TEMP-PLATES for condition and security. TEMP-PLATES must not show evidence of overtemperature indication, deterioration, debonding, or excessive discoloration of the epoxy overcoating.</p> <p><u>TRANSMISSION</u></p> <p>1. Check for proper oil level.</p> <p>2. Check external oil filter for bypass indication.</p> <p>3. Visually inspect transmission cases for damage, condition, and evidence of leaking.</p> <p>4. Visually inspect accessories for condition, damage, and security of attachment.</p> <p>5. Visually inspect external oil lines and hoses for condition, damage, chafing and leaks, paying particular attention to lines running aft of the thermostatic relief valve.</p> <p>6. Visually inspect mast assembly for corrosion and mechanical damage, and mast seal for leakage.</p> <p>7. Transmission mount dust boots for condition.</p>		

SCHEDULED INSPECTIONS

5-8. DAILY INSPECTION — PART A (CONT)

DATA REFERENCE	INSPECTION TASK DESCRIPTION	INITIAL MECH OTHER	
Chapter 64	<p><u>TAIL ROTOR HUB AND BLADE ASSEMBLY</u></p> <div style="text-align: center; margin: 10px 0;">  <p>WARNING</p> </div> <p>NO CRACKS ARE PERMITTED ON ANY SURFACE OF THE TAIL ROTOR BLADES.</p> <ol style="list-style-type: none"> 1. Tail rotor blades for condition of bond lines, cracks, corrosion, leading edge erosion, damage, security, and cleanliness. Clean blades are required to maintain enhanced visibility for safety. 2. Tail rotor hub for security, corrosion, and condition. 3. Flapping bearings and pitch change bearings for excessive looseness and freedom of movement through full range of travel with anti-torque pedals positioned full right and then full left. 4. Tail rotor pitch change links, crosshead, pitch horns, counterweight arms, and links for security, corrosion, and condition. 5. Pitch link bearing and counterweight link bearing looseness shall not exceed 0.015 inch (0.38 mm) axial. Check freedom of movement through full range of travel with antitorque pedals positioned full right and then full left. 6. Pitch change links for binding with tail rotor blade moved to both full flapping positions. Binding is not acceptable. 		



SCHEDULED INSPECTIONS

5-8. DAILY INSPECTION — PART A (CONT)

DATA REFERENCE	INSPECTION TASK DESCRIPTION	INITIAL MECH OTHER	
Chapter 65	<p><u>TAIL ROTOR DRIVESHAFT</u></p> <p style="text-align: center;">NOTE</p> <p>Step 1 through step 6 pertain to helicopters S/N 33001 through 33213 and 36001 through 36019 not modified by 412-570-001-003 or Pre BHT-412-SI-74 (412SP to 412HP Upgrade).</p> <div style="text-align: center; border: 1px solid black; padding: 5px; width: fit-content; margin: 10px auto;"> WARNING </div> <p>CAUSE OF ANY DISCOLORATION SHALL BE DETERMINED AND CORRECTED PRIOR TO NEXT FLIGHT.</p> <ol style="list-style-type: none"> 1. Hanger assemblies — bearings and surrounding areas for evidence of grease leakage, condition, damage, security, corrosion, and overheating. Discoloration of bearing (color change to blue to blue/black in color) or multi-color appearance of hanger that darkens adjacent to bearing is evidence of overheating. Brown color of bearing shield is normal and is not evidence of overheating. 2. Driveshaft sections for cracks, rivet failure, distortion, dents, corrosion and damage to anodized finish. <p style="text-align: center;">NOTE</p> <p>Do not mistake empty imprints in bonding material next to balance strip, as an indication of a missing balance strip. This spot results from removal of a test coupon to inspect for bonding voids. If a tail rotor driveshaft has more than a single empty bonding imprint, remove and send to Bell for repair and balancing.</p> <ol style="list-style-type: none"> 3. Driveshaft for missing balance strips. 4. Clamp sets for condition, security, and proper installation. 		



SCHEDULED INSPECTIONS

5-8. DAILY INSPECTION — PART A (CONT)

DATA REFERENCE	INSPECTION TASK DESCRIPTION	INITIAL	
		MECH	OTHER
	<div data-bbox="678 499 896 571" style="text-align: center; border: 1px solid black; padding: 5px; background-color: #f0f0f0; margin-bottom: 10px;"> WARNING </div> <p data-bbox="477 604 1097 695" style="text-align: center;">CAUSE OF ANY DISCOLORATION SHALL BE DETERMINED AND CORRECTED PRIOR TO NEXT FLIGHT.</p> <p data-bbox="412 760 1162 972">5. Flexible couplings and surrounding areas for grease leakage, damage, corrosion, and evidence of overheat as indicated by TEMP-PLATES or coupling discoloration. A change in color of one or more of the red bordered TEMP-PLATE dots from white/off-white to black indicates an overheat condition and may require replacement of both outer and inner couplings (step 6).</p> <p data-bbox="412 1010 1162 1129">6. Overheat TEMP-PLATES for condition and security. TEMP-PLATES must not show evidence of over temperature indication, deterioration, debonding, or excessive discoloration of the epoxy overcoating.</p> <div data-bbox="753 1180 829 1207" style="text-align: center; margin-bottom: 10px;"> NOTE </div> <p data-bbox="477 1228 1097 1377" style="text-align: center;">Step 7 through step 11 pertain to helicopters S/ N 36020 through 36999, S/N 37002 through 37999, S/N 38001 through 38999, S/N 39101 through 39999, and helicopters modified by 412-570-001-103 or Post BHT-412-SI-74 (412SP to 412HP Upgrade).</p> <div data-bbox="678 1461 896 1533" style="text-align: center; border: 1px solid black; padding: 5px; background-color: #f0f0f0; margin-bottom: 10px;"> WARNING </div> <p data-bbox="477 1566 1097 1656" style="text-align: center;">CAUSE OF ANY DISCOLORATION SHALL BE DETERMINED AND CORRECTED PRIOR TO NEXT FLIGHT.</p>		



SCHEDULED INSPECTIONS

5-8. DAILY INSPECTION — PART A (CONT)

DATA REFERENCE	INSPECTION TASK DESCRIPTION	INITIAL	
		MECH	OTHER
	<p>7. Hanger assemblies — bearings and surrounding areas for evidence of grease leakage, condition, damage, security, corrosion, and overheating. Discoloration of bearing (blue or blue/black in color) or multi-color appearance of hanger that darkens adjacent to bearing is evidence of overheating. Brown color of bearing shield is normal and is not evidence of overheating.</p> <p>8. Driveshaft sections for cracks, rivet failure, distortion, dents, corrosion and damage to anodized finish.</p> <p>9. Disc pack couplings for separation, deflection, distortion, cracks, or missing sections, and correct installation of bolts and washers.</p> <div style="text-align: center; margin: 20px 0;">  <p>WARNING</p> </div> <p>CAUSE OF ANY DISCOLORATION SHALL BE DETERMINED AND CORRECTED PRIOR TO NEXT FLIGHT.</p> <p>10. Coupling assembly at first hanger and adjacent to transmission and surrounding area for grease leakage, damage, corrosion, and evidence of overheat as indicated by TEMP-PLATES or coupling discoloration. A change in color of one or more of the red bordered TEMP-PLATE dots from white/ off-white to black indicates an overheat condition and may require replacement of both outer and inner couplings (step 11).</p> <p>11. Overheat TEMP-PLATES for condition and security. TEMP-PLATES must not show evidence of over temperature indication, deterioration, debonding, or excessive discoloration of the epoxy overcoating.</p>		



SCHEDULED INSPECTIONS

5-8. DAILY INSPECTION — PART A (CONT)

DATA REFERENCE	INSPECTION TASK DESCRIPTION	INITIAL	
		MECH	OTHER
Chapter 65	<p><u>INTERMEDIATE GEARBOX</u></p> <p style="text-align: center;">NOTE</p> <p>Step 1 through step 4 pertain to helicopters S/N 33001 through 33213 and 36001 through 36019 not modified by 412-570-001-103 or Pre BHT-412-SI-74 (412SP to 412HP Upgrade).</p> <p>1. Gearbox assembly for security, condition, corrosion, damage, and oil leaking.</p> <div style="text-align: center; border: 1px solid black; padding: 5px; width: fit-content; margin: 10px auto;"> <p>WARNING</p> </div> <p>CAUSE OF ANY DISCOLORATION SHALL BE DETERMINED AND CORRECTED PRIOR TO NEXT FLIGHT.</p> <p>2. Input and output quill flexible couplings (and surrounding area) for grease leakage, damage, corrosion, and evidence of overheat as indicated by TEMP-PLATES or coupling discoloration. A change in color of one or more of the red bordered TEMP-PLATE dots from white/off-white to black indicates an overheat condition and may require replacement of both outer and inner couplings (step 3).</p> <p>3. Overheat TEMP-PLATES for condition and security. TEMP-PLATES must not show evidence of over temperature indication, deterioration, debonding, or excessive discoloration of the epoxy overcoating.</p> <p>4. Gearbox for proper oil level and oil for evidence of contamination.</p> <p style="text-align: center;">NOTE</p> <p>Step 5 through step 8 pertain to helicopters S/ N 36020 through 36999, S/N 37002 through 37999, S/N 38001 through 38999, S/N 39101 through 39999 and helicopters modified by 412-570-001-103 or Post BHT-412-SI-74 (412SP to 412HP Upgrade).</p>		



SCHEDULED INSPECTIONS

5-8. DAILY INSPECTION — PART A (CONT)

DATA REFERENCE	INSPECTION TASK DESCRIPTION	INITIAL MECH OTHER	
Chapter 65	<p>5. Gearbox assembly for security, condition, corrosion, damage, and oil leaking.</p> <div style="text-align: center; margin: 10px 0;"> <div style="border: 1px solid black; padding: 2px; display: inline-block;">WARNING</div> </div> <p>CAUSE OF ANY DISCOLORATION SHALL BE DETERMINED AND CORRECTED PRIOR TO NEXT FLIGHT.</p> <p>6. Output quill outer couplings (and surrounding area) for grease leakage, damage, corrosion, and evidence of overheat as indicated by TEMP-PLATES or coupling discoloration. A change in color of one or more of the red bordered TEMP-PLATE dots from white/off-white to black indicates an overheat condition and may require replacement of both outer and inner couplings (step 7).</p> <p>7. Overheat TEMP-PLATES for condition and security. TEMP-PLATES must not show evidence of over temperature indication, deterioration, debonding, or excessive discoloration of the epoxy overcoating.</p> <p>8. Gearbox for proper oil level and oil for evidence of contamination.</p> <p><u>TAIL ROTOR GEARBOX</u></p> <div style="text-align: center; margin: 10px 0;"> <p>NOTE</p> <p>Step 1 through step 4 pertain to helicopters S/N 33001 through 33213 and 36001 through 36019 not modified by 412-570-001-103 or Pre BHT-412-SI-74 (412SP to 412HP Upgrade).</p> </div> <p>1. Gearbox assembly for security, condition, corrosion, damage, and oil leaking.</p>		



SCHEDULED INSPECTIONS

5-8. DAILY INSPECTION — PART A (CONT)

DATA REFERENCE	INSPECTION TASK DESCRIPTION	INITIAL MECH OTHER	
Chapter 67	<div style="text-align: center; border: 1px solid black; padding: 5px; width: fit-content; margin: 0 auto;"> WARNING </div> <p style="text-align: center;">CAUSE OF ANY DISCOLORATION SHALL BE DETERMINED AND CORRECTED PRIOR TO NEXT FLIGHT.</p> <p>2. Input quill flexible coupling (and surrounding area) for grease leakage, damage, corrosion, and evidence of overheat as indicated by TEMP-PLATES or coupling discoloration. A change in color of one or more of the red bordered TEMP-PLATE dots from white/off-white to black indicates an overheat condition and may require replacement of both outer and inner couplings (step 3).</p> <p>3. Overheat TEMP-PLATES for condition and security. TEMP-PLATES must not show evidence of overtemperature indication, deterioration, debonding, or excessive discoloration of the epoxy overcoating.</p> <p>4. Gearbox for proper oil level and oil for evidence of contamination.</p> <p style="text-align: center;">NOTE</p> <p style="text-align: center;">Step 5 and step 6 pertain to helicopters S/N 36020 through 36999, S/N 37002 through 37999, S/N 38001 through 38999, S/N 39101 through 39999, and helicopters modified by 412-570-001-103 or Post BHT-412-SI-74 (412SP to 412HP Upgrade).</p> <p>5. Gearbox assembly for security, condition, corrosion, damage, and oil leaking.</p> <p>6. Gearbox for proper oil level and oil for evidence of contamination.</p> <p><u>FLIGHT CONTROLS</u></p> <p>1. Inspect flight control tubes for condition, corrosion, and security.</p>		



SCHEDULED INSPECTIONS

5-8. DAILY INSPECTION — PART A (CONT)

DATA REFERENCE	INSPECTION TASK DESCRIPTION	INITIAL	
		MECH	OTHER
Chapter 71	<p>2. Visually inspect elevators for damage and security. Check elevator control tube for positive spring action and freedom of movement.</p> <p><u>LEFT POWER SECTION</u></p> <p>1. Inspect gas generator case for cracks, buckled areas, and hot spots.</p> <p>2. Inspect oil and fuel hoses and tubes for chafing, leaking, and security.</p> <p>3. Inspect electrical wiring for fraying, chafing, and security.</p> <p>4. Check for proper oil level.</p>		
Chapter 71	<p><u>RIGHT POWER SECTION</u></p> <p>1. Inspect gas generator case for cracks, buckled areas, and hot spots.</p> <p>2. Inspect oil and fuel hoses and tubes for chafing, leaking, and security.</p> <p>3. Inspect electrical wiring for fraying, chafing, and security.</p> <p>4. Check for proper oil level.</p>		
Chapter 71	<p><u>REDUCTION GEARBOX</u></p> <p>1. Inspect hoses and lines for chafing, leaking, and security.</p> <p>2. Check oil filter impending bypass indicator button — not extended.</p> <p>3. Check for proper oil level.</p>		
Chapter 71	<p><u>ENGINE AND REDUCTION GEARBOX MOUNTS</u></p> <p>Inspect mounts for loose bearings and security.</p>		



SCHEDULED INSPECTIONS

5-8. DAILY INSPECTION — PART A (CONT)

DATA REFERENCE	INSPECTION TASK DESCRIPTION	INITIAL	
		MECH	OTHER
Chapter 71	<p><u>ENGINE FIREWALLS</u></p> <p>Visually inspect firewalls for cracks, distortion, missing rivets, broken spot welds, and deteriorating seals or gaskets.</p>		
Chapter 71	<p><u>ENGINE AIR MANAGEMENT SYSTEM</u></p> <p>1. Visually inspect exhaust ejectors and ducts for damage and security.</p> <p>2. Visually inspect air ducts and plenum for condition, obstruction, and security.</p>		
Chapter 79	<p><u>ENGINE OIL SYSTEM</u></p> <p>1. Visually inspect oil coolers for leaks, damage and obstructions.</p> <p>1. Visually inspect engine accessory and reduction gearboxes for oil leaks.</p>		
Chapter 95	<p><u>INSTRUMENTS</u></p> <p>1. Visually inspect instrument panel for cleanliness.</p> <p>2. Visually inspect all instruments, placards, decals, and markings for appearance and legibility.</p> <p>3. Check magnetic compass for condition and security.</p> <p>4. Visually inspect compass cards for validity.</p>		
Chapter 96	<p><u>ELECTRICAL SYSTEM</u></p> <p>1. Inspect electrical equipment in nose compartment for condition and security.</p> <p>2. Inspect pedestal mounted avionics/electrical equipment for condition, cleanliness, and security.</p> <p>3. Inspect overhead console for condition, cleanliness, and security.</p>		



SCHEDULED INSPECTIONS

5-8. DAILY INSPECTION — PART A (CONT)

DATA REFERENCE	INSPECTION TASK DESCRIPTION	INITIAL	
		MECH	OTHER
Chapter 96	<p>4. Inspect all instrument lights, integrally lit panels, secondary lights, and map lights serviceability.</p> <p>5. Inspect all caution and warning lights for proper operation by using master caution, fire test, and baggage compartment smoke detector press-to-test functions.</p> <p>6. Check landing and search lights for condition and security.</p> <p>7. Navigation and anticollision lights for condition and security.</p>		
	<p><u>BATTERY SYSTEM</u></p> <p>1. Visually inspect battery and external connections for condition and security.</p> <p>2. Visually inspect battery vent and drain tubes for obstruction and security.</p>		
	<p><u>ANTENNAS</u></p> <p>Visually inspect all antennas located on fuselage and tailboom for condition and security.</p>		
	<p><u>AVIONICS EQUIPMENT</u></p> <p>Visually inspect all avionics located in fuselage and tailboom for condition and security.</p>		
Chapter 97			
Chapter 97			

SCHEDULED INSPECTIONS

5-9. 100 HOUR/12 MONTH INSPECTION — PART A

DATA REFERENCE	INSPECTION TASK DESCRIPTION	INITIAL	
		MECH	OTHER
<p>Paragraph 5-16</p> <p>Chapter 4</p>	<p>DATE: _____ W.O. _____</p> <p>FACILITY: _____</p> <p>HELICOPTER S/N: _____</p> <p>REGISTRY NO.: _____</p> <p>TOTAL TIME: _____</p> <p>SIGNATURE: _____</p> <p style="text-align: center;">NOTE</p> <p>For helicopters on the Part A inspection program, accomplish each 100 hours of flight operation or after 12 calendar months, whichever comes first.</p> <p><u>GENERAL</u></p> <ol style="list-style-type: none"> 1. Each listed inspection item or maintenance function is to be performed in accordance with the BHT-412-MM chapter specified or the BHT-412-CR&O. 2. Refer to the applicable Pratt & Whitney Canada Engine Maintenance Manual for engine inspection requirements. 3. Record all work accomplished during inspection in the helicopter maintenance record. 4. Check helicopter records for recorded discrepancies. 5. Accomplish complete Daily Inspection — Part A. 6. Review special inspections and perform any special inspection required. 7. Replace all finite life components that have completed published operating limitations. 		

SCHEDULED INSPECTIONS

5-9. 100 HOUR/12 MONTH INSPECTION — PART A (CONT)

DATA REFERENCE	INSPECTION TASK DESCRIPTION	INITIAL	
		MECH	OTHER
<p>Paragraph 5-52</p> <p>Chapter 12</p>	<p>8. Overhaul all components that have completed published overhaul periods.</p> <p>9. Perform lubrication requirements.</p> <p>10. Remove all panels, fairings, and cowlings required to satisfactorily carry out the inspection.</p> <p style="text-align: center;">NOTE</p> <p style="text-align: center;">The following step is to be performed every 12 calendar months.</p> <p>11. Inspect all fuel system, oil system, and hydraulic system filler caps for proper functioning and sealing. Make sure the sealing O-rings within the filler caps are in good condition. Repair or replace the filler caps or replace sealing O-rings as required.</p> <p style="text-align: center;"><u>AFTER COMPLETION OF INSPECTION</u></p> <p>1. Reinstall all panels, fairings, and cowlings removed during inspection.</p> <p>2. Carry out a ground run and leak check prior to releasing the helicopter back to service.</p>		
<p>Chapter 21</p>	<p style="text-align: center;"><u>HEAT/VENT AIR DUCTS</u></p> <p>1. Visually inspect all heating, ventilation, cooling ducts, and controls for cracks, security, and for proper operation.</p> <p style="text-align: center;">Every sixth 100 hour inspection (600 hours) or 12 months:</p>		
<p>Chapter 96</p>	<p>1. Bleed air heating and ventilation/defog system components:</p> <p style="padding-left: 40px;">a. Perform operational check of bleed air heating system and components.</p> <p style="padding-left: 40px;">b. Perform operational check of defog blower.</p>		

SCHEDULED INSPECTIONS

5-9. 100 HOUR/12 MONTH INSPECTION — PART A (CONT)

DATA REFERENCE	INSPECTION TASK DESCRIPTION	INITIAL	
		MECH	OTHER
Chapter 25	<p><u>MISCELLANEOUS FURNISHINGS</u></p> <p>1. Check all safety equipment for inspection due dates and operation.</p>		
Chapter 26	<p><u>FIRE PROTECTION</u></p> <p>1. Make sure fire extinguishers are properly charged.</p> <p>2. Baggage compartment smoke detector for condition and security.</p> <p>Every sixth 100 hour inspection (600 hours) or 12 months:</p>		
Chapter 26	<p>1. Weight check crew and passenger cabin portable fire extinguishers.</p>		
ASB 412-12-152	<p>2. Visually inspect the loop clamp installed on modified discharge tubes 212-060-921-001FM and -002FM for condition and security until Part III of referenced ASB is accomplished.</p>		
Chapter 96	<p>3. Perform operational check of engine fire extinguishing system.</p> <p>4. Perform operational check of baggage compartment smoke detector.</p>		
Chapter 4	<p>5. Replace engine fire extinguisher container firing cartridges in accordance with specified service life.</p>		
Chapter 28	<p><u>FUEL SYSTEM</u></p> <p>1. Inspect all exposed fuel lines and connections for leakage, damage, and security.</p> <p>Every sixth 100 hour inspection (600 hours) or 12 months:</p> <p>2. Remove four access doors, located just forward of the aft crosstube, from the underside of the fuselage. Inspect fuel lines for evidence of leakage, damage, and security.</p>		



SCHEDULED INSPECTIONS

5-9. 100 HOUR/12 MONTH INSPECTION — PART A (CONT)

DATA REFERENCE	INSPECTION TASK DESCRIPTION	INITIAL	
		MECH	OTHER
Chapter 29	<p><u>HYDRAULIC SYSTEMS</u></p> <p>1. Inspect all lines and hoses for security and general condition.</p> <p>Every sixth 100 hour inspection (600 hours) or 12 months:</p> <p style="text-align: center;">NOTE</p> <p>Hydraulic filter elements 205-076-034-003 are non-cleanable. It is recommended they be replaced every 600 hours or 12 months. Filter elements 205-076-034-007 are cleanable. The 212-076-006-007 assembly must have -007 element only. The -003 and -007 elements are interchangeable on the assembly 212-076-006-105; intermixing of different element types is not permitted.</p> <p>1. Remove and inspect hydraulic filter elements.</p> <p>2. Discard or clean filter elements as applicable.</p> <p>3. Install hydraulic filter elements.</p>		
Chapter 63	<p>4. Install 0 to 500 PSI (0 to 3447 kPa) gauge in quick disconnect at rotor brake caliper. Slowly pull rotor brake handle through travel. Cylinder should generate 240 to 260 PSI (1655 to 1793 kPa) at any handle velocity and shall maintain 150 PSI (1034 kPa) minimum in over center position for 3 minutes. Adjust as necessary.</p> <p>5. Inspect brake linings for wear (minimum thickness 0.150 inch (3.81 mm)).</p>		
Chapter 32	<p><u>LANDING GEAR</u></p> <p>1. Inspect landing gear crosstube assemblies, skid tubes, and skid shoes, for condition and security of attachment. Inspect crosstube retention cap (rubber bumper pads) for condition and security of attachment.</p> <p>2. Aft crosstube assemblies support beam for cracks, damage, corrosion, and security of attachment.</p>		



SCHEDULED INSPECTIONS

5-9. 100 HOUR/12 MONTH INSPECTION — PART A (CONT)

DATA REFERENCE	INSPECTION TASK DESCRIPTION	INITIAL	
		MECH	OTHER
BHT-412-SI-58 Chapter 52	<p>3. Crosstube to skid tube saddle bolts for tightness.</p> <p>4. Torque check forward and aft cross tube support fittings U-bolts to 80 to 100 inch-pounds (9.04 to 11.29 Nm).</p> <p>5. Torque check ground handling wheel attachment eyebolts on skid tubes 40 to 58 foot-pounds (54 to 79 Nm). Eyebolts that rotate prior to reaching 40 foot-pounds (54 Nm) shall be removed and inspected for evidence of bending. No bending is permitted.</p> <p>Every third 100 hour inspection (300 hours) or 12 months:</p> <p>6. If gross weight towing kit provisions are installed, inspect fitting assembly for condition and security. Torque check attachment bolts 160 to 190 inch-pounds (18.1 to 21.4 Nm). If bolts are found loose, inspect for condition.</p> <p><u>DOORS AND WINDOWS</u></p> <p>1. Crew and passenger doors structure for corrosion, damage, distortion, and positive locking mechanisms. Seals for adherence, tears, separations, and deterioration.</p> <p>Every third 100 hour inspection (300 hours) or 12 months:</p> <p>2. Crew door emergency jettison mechanism for condition and security. Perform operational check.</p> <p>3. Passenger door window retainers and fillers for damage.</p> <p>4. Nose, electrical, and equipment compartment access doors for corrosion, damage, distortion, and positive locking mechanisms.</p> <p>5. Baggage compartment door for corrosion, damage, and positive locking.</p> <p>6. Inspect heated windshield, if installed, for condition and proper operation.</p>		



SCHEDULED INSPECTIONS

5-9. 100 HOUR/12 MONTH INSPECTION — PART A (CONT)

DATA REFERENCE	INSPECTION TASK DESCRIPTION	INITIAL	
		MECH	OTHER
Chapter 53	<p><u>FUSELAGE</u></p> <p>1. Inspect fuselage tailboom attachment points for evidence of fretting.</p>		
DELETED	<p>2. DELETED</p> <p>3. Move pylon fore and aft, using mast as lever. Check friction dampers for freedom of movement and smooth operation.</p> <p>4. Inspect transmission mounts, mounting brackets, and structure for cracked or broken parts.</p> <p>5. Inspect lift link and fitting for cracks and security.</p> <p>6. Cabin interior and exterior for corrosion and damage.</p> <p>7. All compartments for evidence of water entrapment and corrosion.</p> <p>8. Ensure all drain holes are open.</p> <p>9. Inspect underside of fuselage:</p> <p style="padding-left: 20px;">a. Fuselage structure for damage, corrosion, and working rivets.</p> <p style="padding-left: 20px;">b. Exterior finish for condition and cleanliness.</p> <p style="padding-left: 20px;">c. Evidence of excessive fluid leakage.</p> <p style="padding-left: 20px;">d. Structure around landing gear for condition.</p> <p style="padding-left: 20px;">e. Forward crosstube support structure for working fasteners, cracks, corrosion, and excessive wear.</p> <p style="padding-left: 20px;">f. Aft crosstube support structure for working fasteners, cracks, corrosion, and excessive wear.</p>		

SCHEDULED INSPECTIONS

5-9. 100 HOUR/12 MONTH INSPECTION — PART A (CONT)

DATA REFERENCE	INSPECTION TASK DESCRIPTION	INITIAL	
		MECH	OTHER
Chapter 53	<p>10. Fuselage bonded panels for damage and delamination.</p> <p>11. Inspect cabin roof structure:</p> <p style="padding-left: 40px;">a. Cabin roof structure, cowlings, and fairing for damage, delamination, and general condition.</p> <p style="padding-left: 40px;">b. Cabin roof and cowling/fairing mounted antennas for condition and security.</p> <p>Every sixth 100 hour inspection (600 hours) or 12 months:</p> <p>1. Inspect fuselage cabin structure:</p> <p style="padding-left: 40px;">a. Fuselage structure for corrosion and damage to finish and sealant. Pay particular attention to edges of joints and seams and around fastener heads.</p> <p style="padding-left: 40px;">b. Engine compartment floor and service deck, FS 155.06 to 241.22, for damage, delamination, and corrosion.</p> <p style="text-align: center;">NOTE</p> <p style="padding-left: 40px;">To adequately inspect the following, it will be necessary to remove the auxiliary fuel tanks if installed.</p> <p>2. Pylon wall for damage, working fasteners, cracks, delamination, and corrosion.</p> <p><u>TAILBOOM</u></p> <p>1. Inspect tailboom attachment points for cracks and security.</p> <p>2. Inspect tailboom exterior and interior structure for corrosion and damage.</p> <p>3. Ensure all drain holes are open.</p>		
Chapter 65	<p>4. Torque check tail rotor gearbox mounting nuts by applying torque in tightening direction, do not exceed 200 inch-pounds (22.6 Nm). If any nut rotates under torque, inspect attachment hardware and tail rotor gearbox for serviceability.</p>		



SCHEDULED INSPECTIONS

5-9. 100 HOUR/12 MONTH INSPECTION — PART A (CONT)

DATA REFERENCE	INSPECTION TASK DESCRIPTION	INITIAL	
		MECH	OTHER
Chapter 67	<p>5. Torque check intermediate gearbox mounting bolts by applying torque in tightening direction, do not exceed 50 inch-pounds (5.65 Nm). If any bolt turns under torque, inspect attachment hardware and intermediate gearbox for serviceability.</p> <p>6. Inspect elevator attachment lugs at each end of elevator horn for cracks and security of attachment. Check elevator horn to elevator spar attaching bolts and surrounding joint for cracks and security of attachment.</p>		
Chapter 53	<p>7. Inspect vertical fin spar caps for cracks and corrosion.</p> <p style="text-align: center;">NOTE</p> <p>If necessary, clean area with cloth dampened with MEK (C-309) or equivalent. Ventilate area to prevent breathing fumes.</p> <p>8. Inspect vertical fin spar caps forward side and web from upper tailboom skin to approximately 4.0 inches (102 mm) below upper tailboom skin as follows: Remove aft tailboom access door. Face aft and use bright light and small mirror to inspect area for cracks, especially near rivets holes.</p> <p style="text-align: center;">NOTE</p> <p>Step 9 and step 10 pertain to helicopters modified with the BLR FastFin™ system kit 412-705-040-101.</p> <p>For helicopters equipped with the Dual Tailboom Strakes and FastFin™ system Supplemental Type Certificate (STC), refer to the applicable BLR Aerospace documents for inspection criteria.</p> <p>9. Inspect upper and lower tail fairings for visible damage to the exterior skin and cracks at the attachment points. If paint is missing locally or has scratches, inspect the fairing for delamination and voids with a tap hammer. Inspect fairings for loose or missing attaching hardware.</p> <p>10. Inspect upper and lower strakes for visible damage, deformation, cracks at the attachment points, and loose or missing rivets.</p>		

SCHEDULED INSPECTIONS

5-9. 100 HOUR/12 MONTH INSPECTION — PART A (CONT)

DATA REFERENCE	INSPECTION TASK DESCRIPTION	INITIAL	
		MECH	OTHER
ASB 412-90-49	<p>Every third 100 hour inspection (300 hours) or 12 months:</p> <ol style="list-style-type: none"> Inspect tailboom joints, splices, longerons, attach fittings, and attaching hardware for corrosion, damage, and cracks. Remove plug button at BS 99.00. 		
	<p style="text-align: center;">NOTE</p> <p>Paint fissures are common in the splice area, cracks will be evident by black powder emanating from cracked area, and corrosion will leave evidence of white powder.</p>		
Chapter 67 ASB 412-15-166	<ol style="list-style-type: none"> Using a borescope or other suitable means, inspect inside of longeron paying particular attention to cracking and/or corrosion in area of splice. Report any cracks to Product Support Engineering. Install plug button with sealant (C-308). Disconnect both ends of control tube 212-001-055-101 from bellcranks 212-001-705-001 and 212-001-759-101. <ol style="list-style-type: none"> Without removing control tube 212-001-055-101, visually inspect control tube for cracks. No cracks permitted. On bellcranks 212-001-705-001 and 212-001-759-101, inspect bearings DAS-14A1-512 for freedom of movement, bearings shall move freely in all directions and rotate freely. If a defective bearing is found, replace defective bearing in accordance with BHT-ALL-SPM. 		
Chapter 62	<p><u>MAIN ROTOR BLADES</u></p> <ol style="list-style-type: none"> Wash main rotor blades. Inspect main rotor blades' upper and lower surfaces for condition of bond lines and doublers. Leading edge for erosion. Blade surfaces for corrosion, cracks, damage, and voids. Inspect blade retention bolts for condition and security. 		

SCHEDULED INSPECTIONS

5-9. 100 HOUR/12 MONTH INSPECTION — PART A (CONT)

DATA REFERENCE	INSPECTION TASK DESCRIPTION	INITIAL MECH OTHER	
Chapter 62	<p style="text-align: center;">NOTE</p> <p>Waxing is not required for blades 412-015-300-109 and subsequent or for any blade finished with polyurethane paint.</p> <p>4. Apply a coat of wax to main rotor blades.</p> <p><u>MAIN ROTOR HUB</u></p> <p>1. Inspect hub assembly for condition, corrosion, and security, paying particular attention to the integrity of sealing.</p> <p>2. Inspect pitch horns for corrosion and cracks in areas surrounding torque transfer pin holes. No cracks permitted.</p> <p>3. Inspect pivot bearings, spindle bearings, and damper set for elastomeric bearing delamination, elastomer degradation, shim cracks, crazing, cracking, or sheeting.</p> <p>4. Inspect damper bearing bumper pads for deterioration or deformation due to contact with yoke.</p> <p>5. Torque check eight yoke assembly through bolt nuts to 70 to 80 foot-pounds (95 to 108 Nm).</p> <p>6. Make sure bolts EWB0420 are installed (16 places) for simple pendulum absorber bracket. Torque check bolts. Apply 29 to 33 foot-pounds (39 to 45 Nm).</p> <p>7. Functionally check arm and bearing (pendulum) assemblies. Apply a minimum of 5 pounds (22.24 N) of force to each arm and bearing assembly (force toward center of yoke). Cycle arm and bearing through full travel.</p> <p>8. Apply force away from center of yoke. Arm and bearing assembly should cycle free and smooth. Roughness and binding are not acceptable.</p> <p>9. Functionally check droop restraint system. Check for engagement of restraint arms in lower detent of cam window. Relieve load on each blade and verify lower clevis moves freely through cam window envelope. Binding and roughness in inboard clevis is not acceptable.</p>		

SCHEDULED INSPECTIONS

5-9. 100 HOUR/12 MONTH INSPECTION — PART A (CONT)

DATA REFERENCE	INSPECTION TASK DESCRIPTION	INITIAL MECH OTHER	
Chapter 62	<p><u>MAIN ROTOR CONTROLS</u></p> <p style="text-align: center;">NOTE</p> <p>Disconnect pitch link upper rod ends from the pitch horns to determine main rotor control bearing wear.</p> <p>1. Swashplate and support assembly:</p> <p style="padding-left: 40px;">a. Inspect for condition and security with special attention to gimbal ring attachment lugs.</p> <p style="text-align: center;">NOTE</p> <p>The presence of black oxide powder will require investigation to determine the cause.</p> <p style="padding-left: 40px;">b. Inspect gimbal ring bearings, liners, and attaching hardware for excessive looseness and wear. Gimbal ring bearing and attaching bolt axial or radial looseness shall not exceed 0.005 inch (0.13 mm) with no binding allowed.</p> <p style="padding-left: 40px;">c. Inspect trunnion bearings and attaching hardware for excessive looseness and wear. Trunnion bearings shall not exceed 0.020 inch (0.51 mm) axial looseness.</p> <p>2. Hub and sleeve assembly:</p> <p style="padding-left: 40px;">a. Inspect for condition and security.</p> <p style="padding-left: 40px;">b. Inspect drive hub and rephasing levers for wear and bearing looseness.</p> <p style="padding-left: 40px;">c. Drive links spherical bearings shall not exceed 0.007 inch (0.18 mm) radial or 0.015 inch (0.38 mm) axial looseness.</p> <p style="padding-left: 40px;">d. Swashplate link non-elastomeric bearing looseness shall not exceed 0.015 inch (0.38 mm) axial.</p> <p>3. Inspect collective lever for condition and security. Trunnion bearing shall not exceed 0.020 inch (0.51 mm) axial looseness.</p>		

SCHEDULED INSPECTIONS

5-9. 100 HOUR/12 MONTH INSPECTION — PART A (CONT)

DATA REFERENCE	INSPECTION TASK DESCRIPTION	INITIAL	
		MECH	OTHER
Chapter 63	<p>4. Inspect pitch links for condition and security. Non-elastomeric bearing looseness shall not exceed 0.007 inch (0.18 mm) radial or 0.015 inch (0.38 mm) axial.</p> <p>Every third 100 hour inspection (300 hours) or 12 months:</p> <p>1. Torque check swashplate link elastomeric rod end bearings (as applicable) attachments bolts to 165 to 200 inch-pounds (18.65 to 22.59 Nm).</p> <p>2. Torque check swashplate outer ring through bolts to 165 to 175 inch-pounds (18.65 to 19.77 Nm).</p> <p>3. Torque check four hub and sleeve to rephasing lever attachment bolts to 24 to 34 foot-pounds (33 to 46 Nm) for 1/2 inch (13 mm) bolts or 160 to 200 inch-pounds (18.08 to 22.59 Nm) for 3/8 inch bolts (if installed).</p> <p>4. Torque check drive link to rephasing lever attachment bolts to 165 to 200 inch-bolts (18.65 to 22.59 Nm).</p> <p>5. Torque check pitch link elastomeric rod end bearings (as applicable) attachment bolts to 165 to 200 inch-pounds (18.65 to 22.59 Nm).</p> <p>6. Torque check swashplate support to mast plate bolts (AN5H-6A) to 130 to 140 inch-pounds (14.69 to 15.81 Nm).</p> <p><u>MAIN ROTOR MAST</u></p> <p>1. Inspect mast assembly for security, corrosion, and mechanical damage.</p> <p>2. Inspect mast torque sensor (if installed) installation for security and condition</p> <p>3. Inspect for evidence of oil leaks at mast bearing cap.</p>		

SCHEDULED INSPECTIONS

5-9. 100 HOUR/12 MONTH INSPECTION — PART A (CONT)

DATA REFERENCE	INSPECTION TASK DESCRIPTION	INITIAL MECH OTHER	
Chapter 63	<p><u>TRANSMISSION</u></p> <ol style="list-style-type: none"> 1. Inspect mounts for damage and security. Check boots for condition and ensure boots are in place. 2. Inspect lift link and attachments for corrosion, damage, and security. Check bearings for looseness. 3. Inspect for evidence of oil leakage. 4. Check all transmission chip detectors for debris and clean. 5. Test all transmission chip detectors electrical circuits. <p>Every third 100 hour inspection (300 hours) or 12 months:</p> <ol style="list-style-type: none"> 1. Check internal oil filter or full flow oil monitor for debris and clean. 2. Torque check top case to ring gear case nuts, ring gear case to main case nuts, and main case to support case nuts to 230 to 250 inch-pounds (25.99 to 28.25 Nm). Retorque as required. 		
Chapter 64	<p><u>TAIL ROTOR HUB AND BLADE ASSEMBLY</u></p> <div style="text-align: center;">  <p>CAUTION</p> </div> <p>COUNTERWEIGHT BELLCRANK RETENTION NUT MS14145L6 OR ITS EQUIVALENT MS17826-6 IS DESIGNATED AS ONE TIME USE ONLY. IF MAINTENANCE ACTION REQUIRES THAT IT BE REMOVED, THE COUNTERWEIGHT BELLCRANK NUT IS TO BE DISCARDED AND REPLACED WITH A NEW NUT. OVERTORQUING OR INCORRECT APPLICATION OF THE NUT COULD CAUSE MECHANICAL FAILURE RESULTING IN EXCESSIVE VIBRATION OR DAMAGE TO THE TAIL ROTOR BLADES.</p>		

SCHEDULED INSPECTIONS

5-9. 100 HOUR/12 MONTH INSPECTION — PART A (CONT)

DATA REFERENCE	INSPECTION TASK DESCRIPTION	INITIAL	
		MECH	OTHER
Chapter 18	<p>1. Inspect the tail rotor counterweight bellcrank 212-011-705-001 retention nuts for cracks, corrosion, and security. Reapply corrosion preventive compound (C-101) if nuts are not completely covered.</p> <p>Every third 100 hour inspection (300 hours) or 12 months:</p> <p>1. Dynamically balance tail rotor.</p> <p>2. Torque check nuts on tail rotor blade retention bolts.</p> <p>3. Torque check tail rotor hub retaining nut.</p>		
Chapter 65	<p><u>TAIL ROTOR GEARBOX</u></p> <p>1. Inspect chip detector for debris. If metallic particles are found, determine and correct cause.</p> <p>2. Clean chip detector.</p> <p>3. Test chip detector electrical circuit.</p>		
Chapter 65	<p><u>TAIL ROTOR DRIVESHAFT</u></p> <p>1. Hanger assemblies for cracks at mounting ears, corrosion, and security of attachment.</p> <p>2. Hanger supports for condition and security of attachment.</p> <p>3. Driveshaft sections and attaching hardware for condition and security.</p> <p>4. S/N 33001 through 36019 not modified by 412-570-001-103 or Pre BHT-412-SI-74 (412SP to 412HP Upgrade) check:</p> <p style="padding-left: 40px;">a. Condition of clamps for tail rotor driveshaft coupling to gearbox couplings (90° apart).</p> <p style="padding-left: 40px;">b. Inspect clamps for cracks in or near the bolt hole lugs.</p>		

SCHEDULED INSPECTIONS

5-9. 100 HOUR/12 MONTH INSPECTION — PART A (CONT)

DATA REFERENCE	INSPECTION TASK DESCRIPTION	INITIAL	
		MECH	OTHER
Chapter 65	<p>5. For helicopters S/N 36020 through 36999, S/N 37002 through 37999, S/N 38001 through 38999, S/N 39101 through 39999, and helicopters modified by 412-570-001-103 or Post BHT-412-SI-74 (412SP to 412HP Upgrade), check disc pack couplings and attaching hardware for condition and security.</p> <p><u>INTERMEDIATE GEARBOX</u></p> <p>1. Inspect chip detector for debris. If metallic particles are found, determine and correct cause.</p> <p>2. Clean chip detector.</p> <p>3. Test chip detector electrical circuit.</p>		
Chapter 67	<p><u>FLIGHT CONTROLS</u></p> <p>1. Inspect all control tube assemblies for clearance, security, and general condition.</p> <p>2. Inspect tube bellcranks, supports, and attaching hardware for corrosion, security, wear, and damage.</p> <p>3. Collective and cyclic flight control actuators, check:</p> <p style="padding-left: 40px;">a. Universal bearings for looseness.</p> <p style="padding-left: 40px;">b. Input lever bearings and bolts for wear and looseness.</p> <p style="padding-left: 40px;">c. Fasteners attaching cylinder lower supports to structure for looseness.</p> <p style="padding-left: 40px;">d. Cylinder lower bearings for looseness.</p> <p style="padding-left: 40px;">e. Actuator assemblies for condition, leakage, and security.</p> <p style="padding-left: 40px;">f. Cylinder extension tubes for condition and security.</p>		

SCHEDULED INSPECTIONS

5-9. 100 HOUR/12 MONTH INSPECTION — PART A (CONT)

DATA REFERENCE	INSPECTION TASK DESCRIPTION	INITIAL	
		MECH	OTHER
	<p>g. Upper cylinder housing mounting bracket for condition and security. Check mounting bracket cavity for corrosion. Cavity drain hole for obstruction. Dust boot for condition. Reapply corrosion preventive compound (C-104) as required.</p> <p>h. Actuator linkage for wear and security.</p> <p>i. Clean exposed area of actuator piston with hydraulic fluid (C-002) or hydraulic fluid (C-072) and lint-free cloth.</p> <p>j. Check cyclic and collective hydraulic cylinders' piston rods for evidence of excessive wear and scoring. Wear of the piston rods indicates cylinder assembly is incorrectly aligned to lower supports and requires adjustment.</p> <p>4. Antitorque controls check:</p> <p>a. Inspect tail rotor control tubes, bellcranks, supports, and attaching hardware between tail rotor pedals and tail rotor gearbox for corrosion, wear, and damage.</p> <p>b. Inspect tail rotor hydraulic actuator for leaks, security of attachment, damage, corrosion, wear, bearings, and linkages for looseness.</p> <p>Every third 100 hour inspection (300 hours) or 12 months:</p> <p>1. Collective and cyclic flight control actuators:</p> <p>a. Torque check nuts attaching actuator cylinder to upper supports.</p> <p>b. Remove bolts attaching actuator to lower supports. Check cylinder alignment to lower support. Rod end bearing side loads are not permitted. Reinstall bolts.</p> <p>2. Aerodynamically actuated elevator check:</p> <p>a. Inspect elevator control tube between forward support bracket and elevator horn for corrosion, wear, and damage.</p> <p>b. Inspect elevator control tube support and attaching hardware for security, corrosion, wear, and damage.</p>		

SCHEDULED INSPECTIONS

5-9. 100 HOUR/12 MONTH INSPECTION — PART A (CONT)

DATA REFERENCE	INSPECTION TASK DESCRIPTION	INITIAL MECH OTHER	
	<p>c. Inspect elevators and support structure for loose or missing rivets, cracks in skin, and corrosion.</p> <p>d. Inspect trailing edge tabs and tip caps for condition and security.</p> <p>e. Functionally check operation of control tube as follows:</p> <div style="text-align: center;">  <p>CAUTION</p> </div> <p>DO NOT RELEASE ELEVATOR AND ALLOW THE SPRING TO DRIVE ELEVATOR BACK TO ORIGINAL POSITION.</p> <p>(1) Move elevator to extreme nose down position and while holding allow to slowly return to original position. Failure to return to original position, binding and/or lock-up are not acceptable.</p> <p>(2) If any of these conditions exist, replace tube.</p> <p>f. Remove elevator control and measure spring breakout force for 90 to 100 pounds (400.34 to 444.80 N).</p> <p>g. Functionally check elevator rigging for proper travel. Measure trailing edge for 16° ±1/4° angle down from upper surface of elevator.</p> <p>Every sixth 100 hour inspection (600 hours) or 12 months:</p> <p>1. Inspect collective flight controls:</p> <p>a. Flight control systems bellcrank and control tubes for damage, chafing, corrosion, and security of attachment.</p> <p>b. Friction shoes and liners for condition.</p> <p>c. Check collective lever friction adjuster for operation.</p> <p>d. Check for proper collective minimum friction.</p>		

SCHEDULED INSPECTIONS

5-9. 100 HOUR/12 MONTH INSPECTION — PART A (CONT)

DATA REFERENCE	INSPECTION TASK DESCRIPTION	INITIAL	
		MECH	OTHER
	<p>e. Check collective flight controls for smooth movement throughout full range of travel.</p> <p>2. Inspect flight controls:</p> <p>a. Flight control systems bellcrank and control tubes for damage, chafing, corrosion, and security of attachment.</p> <p>b. Check cyclic stick friction adjuster for proper operation.</p> <p>c. Check for proper cyclic minimum friction.</p> <p>d. Check cyclic flight controls for smooth movement throughout full range of travel.</p> <p>3. Inspect anti-torque flight controls:</p> <p>a. Flight control systems bellcrank and control tubes for damage, chafing, corrosion, and security of attachment.</p> <p>b. Check anti-torque friction adjuster for proper friction.</p> <p>c. Check anti-torque flight controls for smooth movement throughout full range of travel.</p> <p>4. Aerodynamically actuated elevator:</p> <p>a. Remove left and right elevators.</p> <p>b. Clean elevator spars and inspect for corrosion.</p> <p>c. Clean internal bore of elevator horn and inspect for corrosion.</p> <p>d. With elevator control removed, attach a spring scale to hole in arm of horn where control tube is normally installed. Pull scale at right angle to arm, verify friction is 26 to 32 pounds (115.65 to 142.34 N). If friction is not within limits, adjust shim thickness.</p> <p>e. Install left and right elevators.</p>		

SCHEDULED INSPECTIONS

5-9. 100 HOUR/12 MONTH INSPECTION — PART A (CONT)

DATA REFERENCE	INSPECTION TASK DESCRIPTION	INITIAL MECH OTHER	
Chapter 71	<p><u>POWER PLANT</u></p> <p>Every third 100 hour inspection (300 hours) or 12 months:</p> <p style="text-align: center;">NOTE</p> <p>Refer to the applicable Pratt & Whitney Canada Engine Maintenance Manual for engine inspection requirements.</p> <ol style="list-style-type: none"> 1. No. 1 (left) engine power section: <ol style="list-style-type: none"> a. Chip detectors for debris. b. Clean chip detectors. c. Test chip detector electrical circuits. 2. No. 2 (right) engine power section: <ol style="list-style-type: none"> a. Chip detectors for debris. b. Clean chip detectors. c. Test chip detector electrical circuits. 3. Reduction (combining) gearbox: <ol style="list-style-type: none"> a. Chip detectors for debris. b. Clean chip detectors. c. Test chip detector electrical circuits. 4. Engine electrical connections: <ol style="list-style-type: none"> a. Power section 1 ignition leads for corrosion, chafing, and security. b. Power section 2 ignition leads for corrosion, chafing, and security. 		



SCHEDULED INSPECTIONS

5-9. 100 HOUR/12 MONTH INSPECTION — PART A (CONT)

DATA REFERENCE	INSPECTION TASK DESCRIPTION	INITIAL	
		MECH	OTHER
<p>Chapter 71 ASB 412-10-140</p> <p>Chapter 76</p> <p>BHT-412-FM</p>	<p>5. Starter generator:</p> <p style="padding-left: 20px;">a. Power section 1 starter generator brushes allowable wear.</p> <p style="padding-left: 20px;">b. Power section 2 starter generator brushes allowable wear.</p> <p style="padding-left: 20px;">c. Power section 1 starter generator cooling ducts for obstruction, kinking, and security.</p> <p style="padding-left: 20px;">d. Power section 2 starter generator cooling ducts for obstruction, kinking, and security.</p> <p>6. Engine fire detection system elements for condition and security.</p> <p style="text-align: center;">NOTE</p> <p style="padding-left: 40px;">If applicable, refer to BHT-412-SI-87 for installation of adjustable seals or refer to Chapter 71 for seal adjustment.</p> <p>7. Inspect the left-hand and right-hand engine air inlet cowlings for gaps between the lower surface of the cowling firewall and the mating horizontal engine firewall.</p> <p style="text-align: center;"><u>ENGINE CONTROLS</u></p> <p>1. Check controls for smooth movement through full range of travel.</p> <p style="padding-left: 20px;">Every third 100 hour inspection (300 hours) or 12 months:</p> <p>1. Inspect engine fuel and power controls:</p> <p style="padding-left: 40px;">a. Engine control linkages for looseness, lost motion, chafing, damage, and security of attachment.</p> <p style="padding-left: 40px;">b. Bellcranks, mounts, and jackshafts for looseness, damage, and security of attachment.</p> <p style="padding-left: 40px;">c. Perform engine fuel control check (not applicable to PT6T-9 engine).</p>		

SCHEDULED INSPECTIONS

5-9. 100 HOUR/12 MONTH INSPECTION — PART A (CONT)

DATA REFERENCE	INSPECTION TASK DESCRIPTION	INITIAL	
		MECH	OTHER
Chapter 96	<p><u>BATTERY SYSTEM</u></p> <ol style="list-style-type: none"> 1. Service battery in accordance with battery manufacturer’s recommendation. 2. Inspect battery compartment for general condition. 3. Check battery mount for security and corrosion. 4. Perform functional test of battery temperature sensor caution light. 		
Chapter 96	<p><u>EMERGENCY BUS AND POWER DIODES</u></p> <p>Every third 100 hour inspection (300 hours) or every 12 months:</p> <ol style="list-style-type: none"> 1. Perform operational check of emergency bus system as follows: <p style="text-align: center;">NOTE</p> <p>Helicopters S/N 33001 through 33107, except those modified for CAA, remove screw, spacer, and washer installed in the emergency load switch guard.</p> <ol style="list-style-type: none"> a. Inspect EMERG BUS INTC circuit breaker for wear. Operate circuit breaker manually and check by feel. Worn or loose circuit breaker is not acceptable. Close circuit breaker. b. Place all switches in OFF or NORM position and close all circuit breakers. c. Connect battery. d. Place BATTERY BUS 1 switch and BATTERY BUS 2 switch in the ON position. Position INV 1 and INV 2 switches in the ON position. Caution panel INVERTER 1 and INVERTER 2 segments should not be illuminated. e. Check emergency bus power by pressing the FIRE EXT PRESS TO TEST button momentarily. Observe both FIRE PULL handle warning lights illuminate. 		

SCHEDULED INSPECTIONS

5-9. 100 HOUR/12 MONTH INSPECTION — PART A (CONT)

DATA REFERENCE	INSPECTION TASK DESCRIPTION	INITIAL	
		MECH	OTHER
	<p>f. Position emergency bus switch to EMERG LOAD position. Check emergency bus power by pressing the FIRE EXT PRESS TO TEST button momentarily. Observe both FIRE PULL handles illuminate. Verify INVERTER 1 and INVERTER 2 segments are illuminated on the caution panel.</p> <p style="text-align: center;">NOTE</p> <p>S/N 33108 through 33213 and 36001 through 36999 — Check INVERTER 1 light segment on the caution panel is not illuminated and INVERTER 2 segment is illuminated.</p> <p>g. Position BATTERY BUS 1 and BATTERY BUS 2 switches off. Check emergency bus power by pressing FIRE EXT PRESS TO TEST button momentarily. Observe FIRE PULL handles illuminate.</p> <p>h. Position INVERTER 1 and INVERTER 2 switches OFF. Position emergency bus switch to NORMAL. Disconnect battery.</p> <p>2. Install screw, spacer, and washer in the emergency load switch guard if removed.</p> <p>3. Perform functional check of power diodes.</p>		

SCHEDULED INSPECTIONS

5-10. 1000 HOUR INSPECTION — PART A

DATA REFERENCE	INSPECTION TASK DESCRIPTION	INITIAL	
		MECH	OTHER
Chapter 62	<p>DATE: _____ W.O. _____</p> <p>FACILITY: _____</p> <p>HELICOPTER S/N: _____</p> <p>REGISTRY NO.: _____</p> <p>TOTAL TIME: _____</p> <p>SIGNATURE: _____</p> <p style="text-align: center;">NOTE</p> <p style="text-align: center;">For helicopters on the Part A inspection program, accomplish each 1000 hours of flight operation.</p> <p><u>GENERAL</u></p> <ol style="list-style-type: none"> 1. Each listed inspection item or maintenance function is to be performed in accordance with the BHT-412-MM chapter specified or the BHT-412-CR&O. 2. Record all work accomplished during inspection in the helicopter maintenance record. 3. Accomplish complete 100 Hour/12 Month Inspection — Part A. <p><u>SWASHPLATE AND SUPPORT ASSEMBLY — HUB AND SLEEVE ASSEMBLY</u></p> <ol style="list-style-type: none"> 1. Disconnect drive and swashplate links from swashplate outer ring, and drive plate set from hub assembly. 2. Disconnect pitch links from main rotor hub pitch horns. 		

SCHEDULED INSPECTIONS

5-10. 1000 HOUR INSPECTION — PART A (CONT)

DATA REFERENCE	INSPECTION TASK DESCRIPTION	INITIAL	
		MECH	OTHER
	<p>3. Check swashplate duplex bearing and collective sleeve hub bearing set for roughness and ease of rotation.</p> <p>4. Purge lubricate bearings.</p> <p>5. Reconnect drive and swashplate links and tubes, and drive plate set to hub assembly.</p>		

SCHEDULED INSPECTIONS

5-11. 5000 HOUR/5 YEAR INSPECTION — PART A

DATA REFERENCE	INSPECTION TASK DESCRIPTION	INITIAL MECH OTHER	
	<p>DATE: _____ W.O. _____</p> <p>FACILITY: _____</p> <p>HELICOPTER S/N: _____</p> <p>REGISTRY NO.: _____</p> <p>TOTAL TIME: _____</p> <p>SIGNATURE: _____</p> <p style="text-align: center;">NOTE</p> <p>For helicopters on the Part A inspection program, accomplish each 5000 hours flight time or 60 months, whichever comes first.</p> <p>This inspection is meant to be a full visual inspection of the airframe primarily for environmental damage and corrosion.</p> <p><u>GENERAL</u></p> <p>Each listed inspection item or maintenance function is to be performed in accordance with the BHT-412-MM chapter specified or the BHT-412-CR&O.</p> <p><u>PRELIMINARY REQUIREMENTS</u></p> <p>1. All work accomplished during this inspection shall be recorded in the helicopter maintenance records.</p> <p>2. Remove all panels, interior coverings, fairings, and cowlings required to satisfactorily carry out the inspection.</p>		

SCHEDULED INSPECTIONS

5-11. 5000 HOUR/5 YEAR INSPECTION — PART A (CONT)

DATA REFERENCE	INSPECTION TASK DESCRIPTION	INITIAL	
		MECH	OTHER
	<p>3. Remove the following items:</p> <ul style="list-style-type: none"> a. Main battery. b. Electrical and avionics equipment from the nose area, as required, to allow a full visual inspection of the nose area to be done. c. Main rotor transmission. d. Intermediate gearbox. e. Tail rotor gearbox. f. Tailboom (to allow a full inspection of the aft fuselage bulkhead and forward tailboom bulkhead). g. Landing gear assembly (to allow a complete inspection of the landing gear attachment points and support structure). <p>4. In addition to the 5000 Hour/5 Year Inspection — Part A items, carry out the following:</p> <ul style="list-style-type: none"> a. Complete Daily Inspection — Part A. b. Complete 100 Hour/12 Month Inspection — Part A. c. Complete 1000 Hour Inspection — Part A. <p><u>AFTER COMPLETION OF INSPECTION</u></p> <p>1. Install the following items:</p> <ul style="list-style-type: none"> a. Main battery. b. Electrical and avionics equipment on the nose area. c. Main rotor transmission. d. Intermediate gearbox. e. Tail rotor gearbox. 		

SCHEDULED INSPECTIONS

5-11. 5000 HOUR/5 YEAR INSPECTION — PART A (CONT)

DATA REFERENCE	INSPECTION TASK DESCRIPTION	INITIAL	
		MECH	OTHER
Chapter 53	<p>f. Tailboom.</p> <p>g. Landing gear assembly.</p> <p>2. Install all panels, interior coverings, fairings, and cowlings removed during inspection.</p> <p>3. Do a ground run and leak check before you return the helicopter to service.</p> <p><u>FORWARD FUSELAGE</u></p> <p>1. Nose panels in area of pitot tube attachment, areas inside and outside for disbonding and cracking.</p> <p>2. Pitot tubes attachment for looseness.</p> <p>3. Nose shelves for damage, corrosion, and disbonding.</p> <p>4. Nose shelf attachment locations for damage, corrosion, and cracking.</p> <p>5. Right and left BL 14.00 main beams, forward of STA 23.00 for damage, corrosion, and cracking.</p> <p>6. Instrument panel attachment structure for damage, corrosion, and cracking, primarily in the door frame attachment area.</p> <p>7. Instrument panel glareshield for chafing and cracking.</p> <p>8. Crew door hinge attachment structure for damage and cracks.</p> <p>9. Outboard cabin post (1, Figure 5-2), cabin roof longeron (2), and windshield frame (5) upper corner area for damage and cracks.</p> <p>10. Striker plates (3 and 4) attachment areas for damage and cracks.</p> <p>11. Striker plates (3 and 4) for excessive wear, damage, and corrosion.</p>		

SCHEDULED INSPECTIONS

5-11. 5000 HOUR/5 YEAR INSPECTION — PART A (CONT)

DATA REFERENCE	INSPECTION TASK DESCRIPTION	INITIAL	
		MECH	OTHER
	<p>12. Cabin floor area under crew doors for chafing and damage.</p> <p>13. Crew door hinges for wear, damage, corrosion, and security of attachment.</p> <p>14. Crew doors for proper fit and operation.</p> <p>15. Crew seat rails for excessive wear and damage.</p> <p>16. Center and outboard bulkhead, below WL 22.00 at FS 23.00, for cracks, deformation, and corrosion along structure joints.</p> <p>17. Collective and cyclic control jackshafts support intercostals for cracks and corrosion.</p> <p>18. Cyclic support for corrosion and cracks.</p> <p>19. Collective, cyclic, and antitorque control system bellcranks, levers, and support brackets for corrosion, cracks, and indication of wear at attaching points.</p> <p>20. Crew seat support beams, at BL 14.00 and 30.00 between FS 23.00 and 74.30, for cracks and corrosion.</p> <p>21. Forward crosstube attachment points and support structure at FS 63.33 and 74.30 for damage, corrosion, and cracks.</p> <p>22. Aft crosstube attachment points and support structure at FS 155.06 and 166.00 for damage, corrosion, and cracks.</p> <p>23. Crew and passenger cabin floor, FS 23.00 to 155.06, for corrosion and damage. Floor bonded panels for voids. Seat fasteners and cargo tie-down rings for condition. Area around pilot and copilot ICS foot switches for cracks.</p> <p style="text-align: center;">NOTE</p> <p style="text-align: center;">In the following step, removal of the fuel cells is not required unless there is evidence of fuel leakage or damage to the fuel cells or structure is suspected.</p>		

SCHEDULED INSPECTIONS

5-11. 5000 HOUR/5 YEAR INSPECTION — PART A (CONT)

DATA REFERENCE	INSPECTION TASK DESCRIPTION	INITIAL MECH OTHER	
	<p>24. All structure under floor panels and in forward fuel cell cavities including caps, angles, transverse bulkheads, and bonded panels between FS 74.30 and 155.06 for damage, corrosion, cracks, and voids.</p> <p style="text-align: center;">NOTE</p> <p>In the following step, removal of the fuel cells is not required unless there is evidence of fuel leakage or damage to the fuel cells or structure is suspected. Structure that is hidden by the fuel cells only needs to be inspected if the fuel cells are removed for some reason or structural damage is suspected.</p> <p>25. All structure under floor panels and in aft fuel cell cavities including caps, angles, and panels between FS 155.06 and 200.00 for damage, corrosion, cracks, and disbonding.</p> <p>26. Bottom skin, FS 23.00 to 243.937, for damage. Joints for corrosion. Access panels and covers for condition and attachment.</p> <p>27. Main transmission compartment interior, FS 129.00 to 166.00 and WL 7.44 to 76.00, for corrosion. Bulkheads and main beam panels for damage and corrosion. Attaching supports and brackets for condition and security.</p> <p>28. Fluid lines in transmission compartment for evidence of leaks, condition, wear, and chafing. Clamps for condition (fluid contamination and swelling) and security of attachment.</p> <p>29. Lift beam fitting for condition and working rivets, lift link attachment bolt hole bores for excessive wear, and bushings for looseness.</p> <p>30. Pylon (transmission) support structure for wear and cracks. Pay particular attention to right and left horizontal supports, forward vertical supports, and aft vertical webs.</p> <p>31. Aft cabin bulkheads, FS 166.00, for damage, upper aft flange for cracks, and bulkhead panel for damage and disbonding.</p>		



SCHEDULED INSPECTIONS

5-11. 5000 HOUR/5 YEAR INSPECTION — PART A (CONT)

DATA REFERENCE	INSPECTION TASK DESCRIPTION	INITIAL	
		MECH	OTHER
	<p>32. Electrical/avionics compartment, FS 166.00 to 243.937, doors for condition and security. Door frames for cracks and corrosion. Compartment interior for condition and joints for corrosion. Skin for damage and cracks.</p> <p>33. Oil cooler compartment, FS 166.00 to 243.937, doors for condition and security. Main beam panels and bulkheads for condition and corrosion.</p> <p>34. Engine deck below the reduction gearbox, FS 211.00 to 238.00 for damage, cracks, and disbonding.</p> <p>35. Firewalls, FS 155.06 to 241.22, for damage, cracks, security of attachment, seals for condition, and seal attachment angles for cracks.</p> <p>36. Cabin roof, FS 35.00 to 166.00 above WL 68.00, BL 50.00 left and right side, for damaged skin and joints for corrosion, bonded panels for disbonding and corrosion. Structure above overhead console (circuit breaker panels) for cracks and corrosion.</p> <p>37. Cargo door tracks for wear, cracks, and corrosion.</p> <p>38. Engine and transmission cowlings and fairings for evidence of chafing, cracks, corrosion, and seals for condition.</p> <p>39. Bulkhead, FS 241.22, for damage, corrosion, and cracks. Tailboom attachment fittings for damage, cracks, and loose fasteners. Tailboom attachment bolt holes for damage and corrosion.</p> <p>40. Discard the upper left-hand attachment bolt. Carry out a detailed visual inspection of the remaining three attachments bolts for mechanical or corrosion damage. Any evidence of corrosion is cause for rejection.</p> <p>41. Apply a light coat of grease (C-561) or grease (C-172) on the shanks of the bolts only. Both threads are to remain dry.</p> <p>42. Install tailboom after completion of inspection with a new upper left-hand bolt and serviceable bolts at the three other locations.</p>		



SCHEDULED INSPECTIONS

5-11. 5000 HOUR/5 YEAR INSPECTION — PART A (CONT)

DATA REFERENCE	INSPECTION TASK DESCRIPTION	INITIAL	
		MECH	OTHER
Chapter 53	<p><u>TAILBOOM</u></p> <ol style="list-style-type: none"> 1. Bulkhead, BS 17.42, for corrosion and cracks. Fuselage attachment bolt holes for damage and corrosion. Barrel nuts for damage and corrosion. 2. Tailboom and fin driveshaft covers for condition and attachment. 3. Tailboom and fin external skin for damage, corrosion, and cracks. 4. Tailboom access panels and covers for condition and attachment. Tail rotor driveshaft cover hinges for wear. 5. Tailboom baggage compartment door for condition, attachment, and door handle operation. 6. Tailboom baggage compartment interior for damage, panels for disbonding, and corrosion. Longerons above roof panel for corrosion and cracks. Longerons below floor panel for corrosion and cracks. 7. Tailboom interior bulkheads and stringers for cracks and corrosion. 8. Intermediate gearbox mount pad for damage, cracks, fretting, and corrosion. 9. Tail rotor gearbox support fitting assembly for damage, cracks, fretting, and corrosion. Pay particular attention to mounting holes and lugs. 10. Tailboom exterior bonded panels adjacent to baggage compartment for damage, delamination, and corrosion. 11. With a borescope or equivalent, inspect interior structure of vertical fin for cracks, corrosion, fretting, and damage. 12. Control tube fairleads (grommets and guides) for wear and security of attachment. 		



SCHEDULED INSPECTIONS

5-11. 5000 HOUR/5 YEAR INSPECTION — PART A (CONT)

DATA REFERENCE	INSPECTION TASK DESCRIPTION	INITIAL	
		MECH	OTHER
Deleted	<u>DELETED.</u>		



Figure 5-1. Deleted

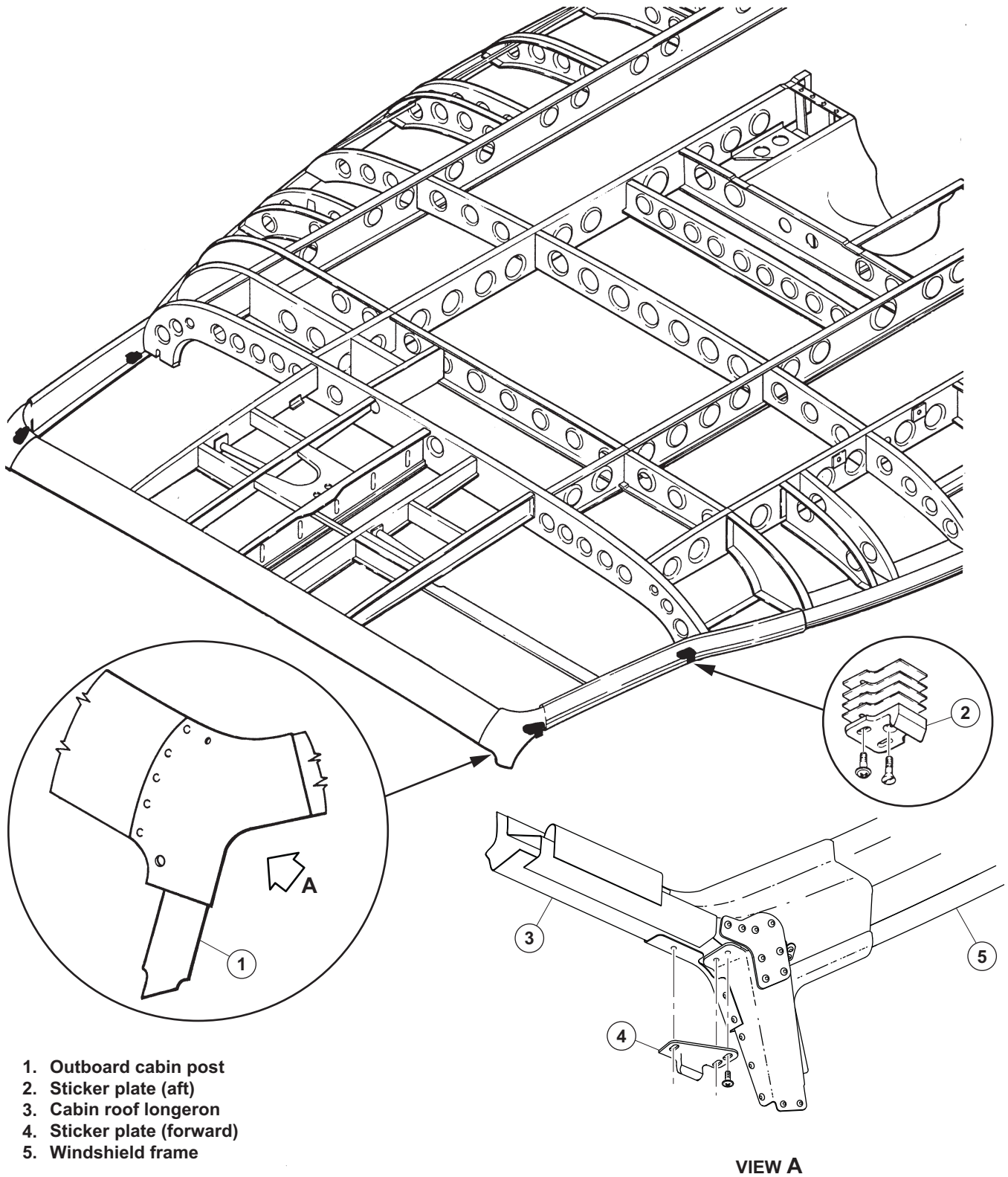

412_MM_05_0004+

Figure 5-2. Cabin Frame Inspection — Part A

SCHEDULED INSPECTIONS

5-12. 25 HOUR/30 DAY INSPECTION — PART B

DATA REFERENCE	INSPECTION TASK DESCRIPTION	INITIAL	
		MECH	OTHER
	<p>DATE: _____ W.O. _____</p> <p>FACILITY: _____</p> <p>HELICOPTER S/N: _____</p> <p>REGISTRY NO.: _____</p> <p>TOTAL TIME: _____</p> <p>SIGNATURE: _____</p> <p style="text-align: center;">NOTE</p> <p style="text-align: center;">For helicopters on the Part B inspection program, accomplish the following checks each 25 hours of flight operation or 30 days, whichever occurs first.</p> <p><u>GENERAL</u></p> <p>1. Each listed inspection item or maintenance function is to be performed in accordance with the BHT-412-MM chapter specified or the BHT-412-CR&O.</p> <p>2. Refer to the applicable Pratt & Whitney Canada Engine Maintenance Manual for engine inspection requirements.</p> <p><u>PRELIMINARY REQUIREMENTS</u></p> <p>1. Use medium helicopter corrosion control guide to establish helicopter corrosion control program.</p> <p>2. Replace all finite life components that have completed published operating limitations.</p> <p>3. Overhaul all components that have completed published overhaul periods.</p> <p>4. Lubricate and service helicopter as required.</p>		
Corrosion Control Guide, CSSD-PSE-87-001.			
Chapter 4			
Chapter 5			
Chapter 12			

SCHEDULED INSPECTIONS

5-12. 25 HOUR/30 DAY INSPECTION — PART B (CONT)

DATA REFERENCE	INSPECTION TASK DESCRIPTION	INITIAL	
		MECH	OTHER
Chapter 5	<p>5. Review Special Inspections and carry out applicable inspections.</p> <p>6. Examine all inspection windows and sight glasses for cracking, crazing, and discoloration. If any of these conditions are present, the part must be removed and replaced prior to returning helicopter for service.</p>		
Service Instruction (SI)	<p>7. Ensure all required inspections of installed BHT kits not covered in this inspection have been performed, as applicable.</p> <p><u>FUSELAGE — NOSE SECTION</u></p>		
Chapter 95	<p>1. Pitot tubes and static ports for visible obstruction and damage.</p>		
Chapter 52	<p>2. Nose doors for damage, corrosion, security of attachment, and for missing or damaged twist fasteners, seal for condition.</p>		
Chapter 53	<p>3. Fuselage:</p> <p style="padding-left: 40px;">a. Forward fuselage area structure and skin for damage, corrosion, cleanliness, and damage to protective finish.</p> <p style="padding-left: 40px;">b. Avionics and electrical compartment for water entrapment.</p>		
Chapter 96	<p>4. Battery installation:</p> <p style="padding-left: 40px;">a. Battery and external connections for security, corrosion, and condition.</p> <p style="padding-left: 40px;">b. Battery vent and drain tubes — unobstructed.</p> <p style="padding-left: 40px;">c. Every fourth 25 hour/30 Day Inspection (100 hours), check battery mounts for corrosion and service battery in accordance with battery manufacturers recommendation.</p>		
Chapter 96	<p>5. Electrical equipment for condition, corrosion, and security.</p>		
Chapter 97	<p>6. Avionics equipment for condition and security.</p>		
Chapter 52	<p>7. All windows for damage and cleanliness.</p>		

SCHEDULED INSPECTIONS

5-12. 25 HOUR/30 DAY INSPECTION — PART B (CONT)

DATA REFERENCE	INSPECTION TASK DESCRIPTION	INITIAL	
		MECH	OTHER
Chapter 30	8. Windshield wiper arms and blades for serviceability and security.		
Chapter 29	9. Remote hydraulic filter bypass indicator-check for bypass indication.		
Chapter 97	10. Antennas for condition and security.		
Chapter 52	11. Crew doors (and surrounding structure) for damage, corrosion, and proper operation, emergency release pins for security.		
	<u>FUSELAGE — CABIN SECTION</u>		
Chapter 53	1. Fuselage structure and compartments for condition, corrosion, water entrapment, and damage to protective finish.		
Chapter 53	2. Fuselage underside for evidence of fuel and hydraulic fluid leakage.		
Chapter 28	3. Visually inspect fuel samples for contamination.		
Chapter 32	4. Landing gear: <ul style="list-style-type: none"> a. Forward crosstube and cap fittings for condition, corrosion, and security of attachment. b. Aft crosstube, cap fittings, and wear strips for condition, corrosion, and security of attachment. c. Aft crosstube support beam for wear, cracks, damage, corrosion, and security of attachment. d. Skid tubes and skid shoes for condition, corrosion, and security of attachment. Replace skid shoes that are worn into shoe surface. Repair weld beads as required. e. Fuselage supports for wear, damage, and security of attachment. 		

SCHEDULED INSPECTIONS

5-12. 25 HOUR/30 DAY INSPECTION — PART B (CONT)

DATA REFERENCE	INSPECTION TASK DESCRIPTION	INITIAL	
		MECH	OTHER
	<p>f. If installed, landing gear forward crosstube crew step fittings for corrosion, damage, and security in area of attachment. If edge sealant is damaged or missing, remove crew step and inspect crosstube for corrosion or damage.</p> <p>g. Tail skid for deformation and security of attachment.</p> <p>h. Emergency float reservoir pressure indicator for proper charge indication (if installed).</p> <p>i. Floats for proper stowage and condition (if installed).</p>		
Chapter 97	5. Antennas for damage, cleanliness, and security.		
Chapter 52	6. Passenger/cargo doors (and surrounding structure) for damage, corrosion, and proper operation. Window seals for condition.		
Chapter 25	7. Crew seats: <ul style="list-style-type: none"> a. Seats for condition, security, and proper operation. b. Cushions and backs for cleanliness, excessive deterioration, and tears. c. Crew seat restraint assemblies for condition, security, and proper operation. d. Crew seat attenuator for compression; inspect witness line. If line is not visible, repair attenuator assembly. 		
Chapter 25	8. Passenger seats: <ul style="list-style-type: none"> a. Seats for condition and security. b. Cushions and backs for cleanliness, excessive deterioration, and tears. c. Passenger seat restraint assemblies for condition, security, and proper operation. 		

SCHEDULED INSPECTIONS

5-12. 25 HOUR/30 DAY INSPECTION — PART B (CONT)

DATA REFERENCE	INSPECTION TASK DESCRIPTION	INITIAL	
		MECH	OTHER
Chapter 95	<p>9. Instruments:</p> <ul style="list-style-type: none"> a. Instrument panel for cleanliness. b. All instrument, placards, decals, and markings for appearance and legibility. c. Check magnetic compass for condition and security. d. All compass cards for validity. 		
Chapter 96 Chapter 97	<p>10. Avionics and electrical equipment:</p> <ul style="list-style-type: none"> a. Pedestal mounted avionics/electrical equipment for condition, cleanliness, and security. b. Overhead console for condition, cleanliness, and security. c. All instrument lights, integrally lit panels, secondary lights, and map lights for serviceability. d. All caution and warning lights for proper operation by using master caution, fire test, and baggage compartment smoke detector press to test functions. e. Landing and search lights for condition and security. f. Navigation and anti-collision lights for condition and security. g. Every fourth 25 Hour/30 Day Inspection, operationally check cabin heater system, bleed air shutoff, and line check valve. 		
Chapter 26	<p>11. Two portable fire extinguishers for condition, mounting, and valid inspection certificate.</p>		

SCHEDULED INSPECTIONS

5-12. 25 HOUR/30 DAY INSPECTION — PART B (CONT)

DATA REFERENCE	INSPECTION TASK DESCRIPTION	INITIAL	
		MECH	OTHER
Chapter 21	<p>12. Cabin heating and ventilating system:</p> <ul style="list-style-type: none"> a. Ventilating system components for condition and security. b. Heat/vent air ducts for condition and proper operation. c. Ventilation/defog components for condition and security. 		
Chapter 25	<p>13. Miscellaneous furnishings (map and data case, first aid kit, and emergency equipment) for condition and security.</p>		
Chapter 63	<p>14. Main rotor transmission:</p> <ul style="list-style-type: none"> a. Proper oil level. b. External oil filter for bypass indication. c. Cases for damage, corrosion, condition, and evidence of leakage. d. Accessories for condition, corrosion, damage, and security of attachment. e. External oil lines and hoses for condition, damage, chafing, and leaks, paying particular attention to lines running aft of the thermostatic relief valve. f. Transmission mount dust boots for condition. <div style="text-align: center; margin: 10px 0;">  <p>WARNING</p> </div> <p>CAUSE OF ANY DISCOLORATION SHALL BE DETERMINED AND CORRECTED PRIOR TO NEXT FLIGHT.</p>		

SCHEDULED INSPECTIONS

5-12. 25 HOUR/30 DAY INSPECTION — PART B (CONT)

DATA REFERENCE	INSPECTION TASK DESCRIPTION	INITIAL	
		MECH	OTHER
Chapter 29	<p>g. Transmission tail rotor output quill coupling (and surrounding area) for grease leakage, damage, corrosion, and evidence of overheat as indicated by TEMP-PLATES or coupling discoloration. A change in color of one or more of the red bordered TEMP-PLATE dots from white/off-white to black, indicates an overheat condition, and may require replacement of both outer and inner couplings (see step h).</p> <p>h. Overheat TEMP-PLATES for condition and security. TEMP-PLATES must not show evidence of overtemperature indication, deterioration, debonding, or excessive discoloration of the epoxy overcoating.</p> <p>15. Hydraulic systems:</p> <p>a. Hydraulic system 1 and 2 filter bypass indicator buttons — not extended.</p> <p>b. Collective and cyclic servo actuators for leaks, corrosion, damage, and security.</p> <p>c. Hydraulic system 1 and 2 valve and filter modules for leaks, damage, and security.</p> <p>d. Hydraulic system 1 and 2 lines, hoses, and fittings for leaks, damage, chafing, kinking, and security.</p> <p>16. Flight control tubes for condition, corrosion, and security.</p>		
Chapter 52	<p><u>FUSELAGE AFT OF CABIN LEFT AND RIGHT SIDE</u></p> <p>1. Avionics/electrical and heater compartment doors for condition and security of attachment. Latches for proper operation.</p>		
Chapter 53	<p>2. Fuselage structure:</p> <p>a. Avionics/electrical and heater compartments for evidence of water entrapment.</p> <p>b. Engine decks for condition and evidence of delamination.</p>		

SCHEDULED INSPECTIONS

5-12. 25 HOUR/30 DAY INSPECTION — PART B (CONT)

DATA REFERENCE	INSPECTION TASK DESCRIPTION	INITIAL	
		MECH	OTHER
Chapter 96 Chapter 97	3. Avionics and electrical equipment for security and condition.		
Chapter 21	4. Heater compartment for cleanliness, condition, and security of heating system components, wiring, ducts and supports. Structure for damage and corrosion (including connections and fasteners).		
Chapter 29	5. Tail rotor hydraulic actuator and hoses for leakage, corrosion, and security.		
Chapter 67	6. Tail rotor control tubes for condition, corrosion, and security.		
Chapter 63	7. Transmission oil cooling system: <ul style="list-style-type: none"> a. Oil coolers for leakage, damage, and obstruction. b. Oil cooler hoses and tubes for leakage, damage, chafing, and fraying. c. Oil cooler blowers for damage, corrosion, and obstruction. 		
Chapter 79	8. Engine oil system: <ul style="list-style-type: none"> a. Oil coolers for leakage, corrosion, damage, and obstruction. b. Oil cooler hoses and tubes for leakage, damage, chafing, and fraying. c. Reduction gearbox oil filter impending bypass indicator button — not extended. d. Power section 1 for proper oil level. e. Power section 2 for proper oil level. f. Reduction gearbox for proper oil level. 		
Chapter 26	9. Engine compartment fire extinguisher containers for proper charge, condition, and mounting.		

SCHEDULED INSPECTIONS

5-12. 25 HOUR/30 DAY INSPECTION — PART B (CONT)

DATA REFERENCE	INSPECTION TASK DESCRIPTION	INITIAL	
		MECH	OTHER
Chapter 71	10. Engine and reduction gearbox mounts for loose bearings and security.		
Chapter 71	11. No.1 (left) engine power section: a. Exhaust ejector and duct for damage and security. b. Gas generator case for cracks, buckled areas, and hot spots. c. Oil and fuel hoses and tubes for chafing, leaking, and security. d. Electrical wiring for fraying, chafing, and security.		
Chapter 71	12. No.2 (right) engine power section: a. Exhaust ejector and duct for damage and security. b. Gas generator case for cracks, buckled areas, and hot spots. c. Oil and fuel hoses and tubes for chafing, leaking, and security. d. Electrical wiring for fraying, chafing, and security.		
Chapter 71	13. Engine firewalls, air intake ducts, and plenum for cracks, distortion, missing rivets, broken spot welds, and deteriorating seals or gaskets.		
Chapter 71	14. Engine cowling for missing fasteners and cracks. Latches for proper operation.		



SCHEDULED INSPECTIONS

5-12. 25 HOUR/30 DAY INSPECTION — PART B (CONT)

DATA REFERENCE	INSPECTION TASK DESCRIPTION	INITIAL	
		MECH	OTHER
Chapter 53	<p><u>FUSELAGE AFT/TAILBOOM ATTACHMENT</u></p> <p>1. Inspect fuselage tailboom attachment points for security and evidence of fretting.</p>		
DELETED	<p>2. DELETED</p> <p><u>TAILBOOM</u></p>		
Chapter 53	<p>1. Tailboom structure:</p> <p style="padding-left: 40px;">a. Exterior structure for condition, damage, and corrosion.</p> <p style="padding-left: 40px;">b. Baggage compartment interior for condition and cleanliness.</p>		
Chapter 52	<p>2. Baggage compartment door for damage, proper operation, and security.</p>		
Chapter 52	<p>3. Driveshaft and intermediate gearbox covers for damage and security.</p>		
Chapter 67	<p>4. Elevators for damage and security. Elevator control tube for positive spring action and freedom of movement.</p>		
Chapter 97	<p>5. Tailboom mounted avionics equipment for condition and security.</p>		
Chapter 53	<p>6. Every fourth 25 Hour/30 Day Inspection:</p> <p style="padding-left: 40px;">a. Inspect vertical fin caps for cracks and/or corrosion.</p> <p style="padding-left: 40px;">b. Inspect interior structure (including joints, splices, longerons, attach fittings, and hardware) for condition, corrosion, damage, and cracks.</p>		



SCHEDULED INSPECTIONS

5-12. 25 HOUR/30 DAY INSPECTION — PART B (CONT)

DATA REFERENCE	INSPECTION TASK DESCRIPTION	INITIAL MECH OTHER	
Chapter 65	<p style="text-align: center;">NOTE</p> <p>Step 7 pertains to helicopters S/N 33001 through 33213 and 36001 through 36019 not modified by 412-570-001-103 or Pre BHT-412-SI-74 (412SP to 412HP Upgrade).</p> <p>7. Tail rotor driveshaft:</p> <div style="text-align: center; border: 1px solid black; padding: 5px; width: fit-content; margin: 10px auto;"> <p>WARNING</p> </div> <p>CAUSE OF ANY DISCOLORATION SHALL BE DETERMINED AND CORRECTED PRIOR TO NEXT FLIGHT.</p> <p>a. Hanger assemblies — bearings and surrounding areas for evidence of grease leakage, condition, damage, security, corrosion, and overheating. Discoloration of bearing (color change to blue or blue/black) or multi-color appearance of hanger that darkens adjacent to bearing is evidence of overheating. Brown color of bearing shield is normal and is not evidence of overheating.</p> <p>b. Driveshaft sections for cracks, rivet failure, distortion, dents, corrosion and damage to anodized finish.</p> <p style="text-align: center;">NOTE</p> <p>Do not mistake empty imprints in bonding material next to balance strip, as an indication of a missing balance strip. This spot results from removal of a test coupon to inspect for bonding voids. If a tail rotor driveshaft has more than a single empty bonding imprint, remove and send to Bell for repair and balancing.</p> <p>c. Driveshaft for missing balance strips.</p> <p>d. Clamp sets for condition, security, and proper installation.</p>		



SCHEDULED INSPECTIONS

5-12. 25 HOUR/30 DAY INSPECTION — PART B (CONT)

DATA REFERENCE	INSPECTION TASK DESCRIPTION	INITIAL MECH OTHER	
Chapter 65	<p style="text-align: center;">WARNING</p> <p>CAUSE OF ANY DISCOLORATION SHALL BE DETERMINED AND CORRECTED PRIOR TO NEXT FLIGHT.</p> <p>e. Flexible couplings and surrounding areas for grease leakage, damage, corrosion, and evidence of overheat as indicated by TEMP-PLATES or coupling discoloration. A change in color of one or more of the red bordered TEMP-PLATE dots from white/off-white to black indicates an overheat condition and may require replacement of both outer and inner couplings (step f).</p> <p>f. Overheat TEMP-PLATES for condition and security. TEMP-PLATES must not show evidence of over temperature indication, deterioration, debonding, or excessive discoloration of the epoxy overcoating.</p> <p style="text-align: center;">NOTE</p> <p>Step 8 pertains to helicopters S/N 36020 through 36999, S/N 37002 through 37999, S/N 38001 through 38999, S/N 39101 through 39999, and helicopters modified by 412-570-001-103 or Post BHT-412-SI-74 (412SP to 412HP Upgrade).</p> <p>8. Tail rotor driveshaft:</p> <p style="text-align: center;">WARNING</p> <p>CAUSE OF ANY DISCOLORATION SHALL BE DETERMINED AND CORRECTED PRIOR TO NEXT FLIGHT.</p>		



SCHEDULED INSPECTIONS

5-12. 25 HOUR/30 DAY INSPECTION — PART B (CONT)

DATA REFERENCE	INSPECTION TASK DESCRIPTION	INITIAL MECH OTHER	
	<p>a. Hanger assemblies — bearings and surrounding areas for evidence of grease leakage, condition, damage, security, corrosion, and overheating. Discoloration of bearing (blue to blue/black in color) or multi-color appearance of hanger that darkens adjacent to bearing is evidence of overheating. Brown color of bearing shield is normal and is not evidence of overheating.</p> <p>b. Driveshaft sections for cracks, rivet failure, distortion, dents, corrosion and damage to anodized finish.</p> <p>c. Deleted.</p> <p>d. Disc pack couplings for separation, deflection, distortion, cracks, or missing sections, and correct installation of bolts and washers.</p> <div style="text-align: center; margin: 20px 0;">  <p>WARNING</p> </div> <p>CAUSE OF ANY DISCOLORATION SHALL BE DETERMINED AND CORRECTED PRIOR TO NEXT FLIGHT.</p> <p>e. Coupling assembly at first hanger and adjacent to transmission and surrounding area for grease leakage, damage, corrosion, and evidence of overheat as indicated by TEMP-PLATES or coupling discoloration. A change in color of one or more of the red bordered TEMP-PLATE dots from white/off-white to black indicates an overheat condition and may require replacement of both outer and inner couplings (step f).</p>		



SCHEDULED INSPECTIONS

5-12. 25 HOUR/30 DAY INSPECTION — PART B (CONT)

DATA REFERENCE	INSPECTION TASK DESCRIPTION	INITIAL MECH OTHER	
Chapter 65	<p>f. Overheat TEMP-PLATES for condition and security. TEMP-PLATES must not show evidence of over temperature indication, deterioration, debonding, or excessive discoloration of the epoxy overcoating.</p> <p style="text-align: center;">NOTE</p> <p style="text-align: center;">Step 9 pertains to helicopters S/N 33001 through 33213 and 36001 through 36019 not modified by 412-570-001-103 or Pre BHT-412-SI-74 (412SP to 412HP Upgrade).</p> <p>9. Intermediate gearbox:</p> <p style="padding-left: 20px;">a. Gearbox assembly for security, condition, corrosion, damage, and oil leaking.</p> <div style="text-align: center; border: 1px solid black; padding: 5px; width: fit-content; margin: 10px auto;"> <p>WARNING</p> </div> <p style="text-align: center;">CAUSE OF ANY DISCOLORATION SHALL BE DETERMINED AND CORRECTED PRIOR TO NEXT FLIGHT.</p> <p style="padding-left: 20px;">b. Input and output quill flexible couplings (and surrounding area) for grease leakage, damage, corrosion, and evidence of overheat as indicated by TEMP-PLATES or coupling discoloration. A change in color of one or more of the red bordered TEMP-PLATE dots from white/off-white to black indicates an overheat condition and may require replacement of both outer and inner couplings (step c).</p> <p style="padding-left: 20px;">c. Overheat TEMP-PLATES for condition and security. TEMP-PLATES must not show evidence of over temperature indication, deterioration, debonding, or excessive discoloration of the epoxy overcoating.</p> <p style="padding-left: 20px;">d. Gearbox for proper oil level and oil for evidence of contamination.</p>		



SCHEDULED INSPECTIONS

5-12. 25 HOUR/30 DAY INSPECTION — PART B (CONT)

DATA REFERENCE	INSPECTION TASK DESCRIPTION	INITIAL MECH OTHER	
Chapter 65	<p style="text-align: center;">NOTE</p> <p>Step 10 pertains to helicopters S/N 36020 through 36999, S/N 37002 through 37999, S/N 38001 through 38999, S/N 39101 through 39999, and helicopters modified by 412-570-001-103 or Post BHT-412-SI-74 (412SP to 412HP Upgrade).</p> <p>10. Intermediate gearbox:</p> <p style="padding-left: 40px;">a. Gearbox assembly for security, condition, corrosion, damage, and oil leaking.</p> <div style="text-align: center; margin: 20px 0;"> <div style="border: 1px solid black; padding: 2px 10px; display: inline-block;">WARNING</div> </div> <p style="text-align: center;">CAUSE OF ANY DISCOLORATION SHALL BE DETERMINED AND CORRECTED PRIOR TO NEXT FLIGHT.</p> <p style="padding-left: 40px;">b. Output quill outer couplings (and surrounding area) for grease leakage, damage, corrosion, and evidence of overheat as indicated by TEMP-PLATES or coupling discoloration. A change in color of one or more of the red bordered TEMP-PLATE dots from white/off-white to black indicates an overheat condition and may require replacement of both outer and inner couplings (step c).</p> <p style="padding-left: 40px;">c. Overheat TEMP-PLATES for condition and security. TEMP-PLATES must not show evidence of over temperature indication, deterioration, debonding, or excessive discoloration of the epoxy overcoating.</p> <p style="padding-left: 40px;">d. Gearbox for proper oil level and oil for evidence of contamination.</p> <p style="text-align: center; margin-top: 20px;">NOTE</p> <p>Step 11 pertains to helicopters S/N 33001 through 33213 and 36001 through 36019 not modified by 412-570-001-103 or Pre BHT-412-SI-74 (412SP to 412HP Upgrade).</p>		



SCHEDULED INSPECTIONS

5-12. 25 HOUR/30 DAY INSPECTION — PART B (CONT)

DATA REFERENCE	INSPECTION TASK DESCRIPTION	INITIAL	
		MECH	OTHER
Chapter 65	<p>11. Tail rotor gearbox:</p> <p>a. Gearbox assembly for security, condition, corrosion, damage, and oil leaking.</p> <div style="text-align: center; border: 1px solid black; padding: 5px; width: fit-content; margin: 10px auto;"> WARNING </div> <p>CAUSE OF ANY DISCOLORATION SHALL BE DETERMINED AND CORRECTED PRIOR TO NEXT FLIGHT.</p> <p>b. Input quill flexible coupling (and surrounding area) for grease leakage, damage, corrosion, and evidence of overheat as indicated by TEMP-PLATES or coupling discoloration. A change in color of one or more of the red bordered TEMP-PLATE dots from white/off-white to black indicates an overheat condition and may require replacement of both outer and inner couplings (step c).</p> <p>c. Overheat TEMP-PLATES for condition and security. TEMP-PLATES must not show evidence of over temperature indication, deterioration, debonding, or excessive discoloration of the epoxy overcoating.</p> <p>d. Gearbox for proper oil level and oil for evidence of contamination.</p> <p style="text-align: center;">NOTE</p> <p>Step 12 pertains to helicopters S/N 36020 through 36999, S/N 37002 through 37999, S/N 38001 through 38999, S/N 39101 through 39999, and helicopters modified by 412-570-001-103 or Post BHT-412-SI-74 (412SP to 412HP Upgrade)</p>		
Chapter 65	<p>12. Tail rotor gearbox:</p> <p>a. Gearbox assembly for security, condition, corrosion, damage, and oil leaking.</p> <p>b. Gearbox for proper oil level and oil for evidence of contamination.</p>		

SCHEDULED INSPECTIONS

5-12. 25 HOUR/30 DAY INSPECTION — PART B (CONT)

DATA REFERENCE	INSPECTION TASK DESCRIPTION	INITIAL	
		MECH	OTHER
Chapter 64	<p>13. Tail rotor hub and blade assembly:</p> <div style="text-align: center; margin: 10px 0;">  <p>WARNING</p> </div> <p>NO CRACKS ARE PERMITTED ON ANY SURFACE OF THE TAIL ROTOR BLADES.</p> <p>a. Tail rotor blades for condition of bond lines, cracks, corrosion, leading edge erosion, damage, security, and cleanliness. Clean blades are required to maintain enhanced visibility for safety.</p> <p>b. Tail rotor hub for security, corrosion, and condition.</p> <p>c. Flapping bearings and pitch change bearings for excessive looseness and freedom of movement through full range of travel with antitorque pedals positioned full right and then full left.</p> <p>d. Tail rotor pitch change links, crosshead, pitch horns, counterweight arms, and links for security, corrosion, and condition.</p> <p>e. Pitch link bearing and counterweight link bearing looseness shall not exceed 0.015 inch (0.38 mm) axial. Check freedom of movement through full range of travel with antitorque pedals positioned full right and then full left.</p> <p>f. Pitch change links for binding with tail rotor blade moved to both full flapping positions. Binding is not acceptable.</p>		

SCHEDULED INSPECTIONS

5-12. 25 HOUR/30 DAY INSPECTION — PART B (CONT)

DATA REFERENCE	INSPECTION TASK DESCRIPTION	INITIAL MECH OTHER	
<p>Chapter 52 Chapter 53</p> <p>Chapter 63</p> <p>Chapter 63 BHT-412-SI-12</p>	<p>14. Every fourth 25 Hour/30 Day inspection:</p> <div style="text-align: center; border: 2px dashed black; padding: 5px; width: fit-content; margin: 10px auto;"> <p>CAUTION</p> </div> <p>COUNTERWEIGHT BELLCRANK RETENTION NUT MS14145L6, OR ITS EQUIVALENT MS17826-6, IS DESIGNATED AS ONE TIME USE ONLY. IF MAINTENANCE ACTION REQUIRES THAT IT BE REMOVED, THE COUNTERWEIGHT BELLCRANK NUT IS TO BE DISCARDED AND REPLACED WITH A NEW NUT. OVERTORQUING OR INCORRECT APPLICATION OF THE NUT COULD CAUSE MECHANICAL FAILURE RESULTING IN EXCESSIVE VIBRATION OR DAMAGE TO THE TAIL ROTOR BLADES.</p> <p>a. Inspect the tail rotor counterweight bellcrank 212-011-705-001 retention nuts for cracks, corrosion, and security. Reapply corrosion preventive compound (C-101) if nuts are not completely covered.</p> <p><u>CABIN ROOF</u></p> <p>1. Cabin structure and cowlings/fairings for condition.</p> <p>2. Transmission and transmission oil lines for condition, corrosion, and leaks.</p> <p>3. Rotor brake quill, disc, and brake assembly (if installed):</p> <p>a. Brake quill for condition, damage, and leakage.</p> <p>b. Brake disc for condition, damage, security, warpage, and evidence of overheating.</p> <p>c. Caliper switches and wiring for condition and security of attachment.</p>		

SCHEDULED INSPECTIONS

5-12. 25 HOUR/30 DAY INSPECTION — PART B (CONT)

DATA REFERENCE	INSPECTION TASK DESCRIPTION	INITIAL	
		MECH	OTHER
Chapter 29	<p>4. Hydraulic systems:</p> <p>a. Hydraulic system 1 and 2 pumps for leakage, damage, and security.</p> <p>b. Hydraulic lines for leaks, chafing, and kinking.</p> <p>c. Hydraulic system 1 and 2 reservoirs for proper fluid levels, damage, corrosion, and security.</p>		
Chapter 62	<p>5. Main rotor blades:</p> <p>a. Wash main rotor blades.</p> <p>b. Main rotor blades for condition, damage, and security.</p> <p style="text-align: center;">NOTE</p> <p>Waxing is not required for blades 412-015-300-109 and subsequent or for any blade finished with polyurethane paint.</p> <p>c. Apply a coat of wax to main rotor blades.</p>		
Chapter 62	<p>6. Main rotor hub:</p> <p>a. Inspect hub assembly for condition, corrosion, and security, paying particular attention to the integrity of sealing.</p> <p>b. Inspect pitch horns for condition, security, and corrosion and cracks in areas surrounding torque transfer pin holes. No cracks permitted.</p> <p>c. Inspect pivot bearings, spindle bearings, and damper set for elastomeric bearing delamination, elastomer degradation, shim cracks, crazing, cracking, or sheeting.</p> <p>d. Inspect damper bearing bumper pads for deterioration or deformation due to contact with yoke.</p> <p>e. Functionally check arm and bearing (pendulum) assemblies. Apply a minimum of 5 pounds (22.24 N) of axial force to each arm and bearing assembly. Cycle arm and bearing through full travel.</p>		

SCHEDULED INSPECTIONS

5-12. 25 HOUR/30 DAY INSPECTION — PART B (CONT)

DATA REFERENCE	INSPECTION TASK DESCRIPTION	INITIAL MECH OTHER	
Chapter 62	<p>f. Apply force away from center of yoke. Arm and bearing assembly should cycle free and smooth. Roughness and binding are not acceptable.</p> <p>g. Functionally check droop restraint system. Check for engagement of restraint arms in lower detent of cam window. Relieve load on each blade and verify lower clevis moves freely through cam window envelope. Binding and roughness in inboard clevis is not acceptable.</p> <p>7. Main rotor controls:</p> <p>a. Visually inspect swashplate and support assembly, and collective lever for condition and security.</p> <p>b. Visually inspect hub and sleeve assembly for condition and security.</p> <p style="text-align: center;">NOTE</p> <p>Use swashplate link and drive link bearings — workaid (Chapter 62) to assist with determining condition of main rotor control bearings.</p> <p>c. Visually inspect drive hub and rephasing levers for bearing looseness and security of attachment.</p> <p>d. Visually inspect pitch links for condition, security, and bearing looseness.</p> <p>8. Every fourth 25 Hour/30 Day Inspection:</p> <p style="text-align: center;">NOTE</p> <p>Disconnect pitch link upper rod ends from the pitch horns to determine main rotor control bearing wear.</p> <p>a. Inspect swashplate and support assembly for condition and security with special attention to gimbal ring attachment lugs.</p>		

SCHEDULED INSPECTIONS

5-12. 25 HOUR/30 DAY INSPECTION — PART B (CONT)

DATA REFERENCE	INSPECTION TASK DESCRIPTION	INITIAL MECH OTHER	
Chapter 63	<p style="text-align: center;">NOTE</p> <p>The presence of black oxide powder will require investigation to determine the cause.</p> <p>b. Inspect gimbal ring bearings, liners, and attaching hardware for excessive looseness and wear. Gimbal ring bearing and attaching bolt axial or radial looseness shall not exceed 0.005 inch (0.13 mm) with no binding allowed.</p> <p>c. Inspect trunnion bearings and attaching hardware for excessive looseness and wear. Trunnion bearings shall not exceed 0.020 inch (0.51 mm) axial looseness.</p> <p>d. Inspect drive hub and rephasing levers for wear and bearing looseness.</p> <p>e. Drive links' spherical bearings shall not exceed 0.007 inch (0.18 mm) radial or 0.015 inch (0.38 mm) axial looseness.</p> <p>f. Swashplate link non-elastomeric bearing looseness shall not exceed 0.015 inch (0.38 mm) axial.</p> <p>g. Collective lever trunnion bearing shall not exceed 0.020 inch (0.51 mm) axial looseness.</p> <p>h. Pitch link's non-elastomeric bearing looseness shall not exceed 0.007 inch (0.18 mm) radial or 0.015 inch (0.38 mm) axial.</p> <p>9. Main rotor mast:</p> <p>a. Inspect mast assembly for security, corrosion, and mechanical damage.</p> <p>b. Inspect for evidence of oil leaks at mast bearing cap.</p>		

SCHEDULED INSPECTIONS

5-12. 25 HOUR/30 DAY INSPECTION — PART B (CONT)

DATA REFERENCE	INSPECTION TASK DESCRIPTION	INITIAL MECH OTHER	
Chapter 63	<p>10. Engine-to-transmission (main) driveshaft:</p> <p>a. Main driveshaft for corrosion, condition, and security.</p> <div data-bbox="761 632 979 705" style="border: 1px solid black; padding: 5px; text-align: center; margin: 10px 0;"> <p>WARNING</p> </div> <p>CAUSE OF ANY DISCOLORATION SHALL BE DETERMINED AND CORRECTED PRIOR TO NEXT FLIGHT.</p> <p>b. Main driveshaft forward and aft couplings, boots, seals (and surrounding area), for grease leakage, damage corrosion and evidence of overheat as indicated by TEMP-PLATES or coupling discoloration. A change in color of any yellow bordered TEMP-PLATE, from white/off-white to black, will indicate a possible overheat condition and /or component degradation (step c). If one or more of the red bordered TEMP-PLATE dots change from white/off-white to black, an overheat condition is present and may require replacement of both outer and inner couplings.</p> <p>c. Overheat TEMP-PLATES for condition and security. TEMP-PLATES must not show evidence of overtemperature indication, deterioration, debonding, or excessive discoloration of the epoxy overcoating.</p>		

SCHEDULED INSPECTIONS

5-13. 300 HOUR/12 MONTH INSPECTION — PART B

DATA REFERENCE	INSPECTION TASK DESCRIPTION	INITIAL	
		MECH	OTHER
	<p>DATE: _____ W.O. _____</p> <p>FACILITY: _____</p> <p>HELICOPTER S/N: _____</p> <p>REGISTRY NO.: _____</p> <p>TOTAL TIME: _____</p> <p>SIGNATURE: _____</p> <p style="text-align: center;">NOTE</p> <p>For helicopters on the Part B inspection program, accomplish the following checks each 300 hours of flight operation or 12 calendar months, whichever occurs first.</p> <p><u>GENERAL</u></p> <p>Each listed inspection item or maintenance function is to be performed in accordance with the chapter specified.</p> <p><u>PRELIMINARY REQUIREMENTS</u></p> <ol style="list-style-type: none"> 1. All work accomplished during inspection shall be recorded in helicopter maintenance records. 2. Remove all panels, fairings, and cowlings required to satisfactorily carry out the inspection. <p><u>AFTER COMPLETION OF INSPECTION</u></p> <ol style="list-style-type: none"> 1. Reinstall all panels, fairings, and cowlings removed during inspection. 2. Carry out a ground run and leak check prior to releasing the helicopter back to service. 		

SCHEDULED INSPECTIONS

5-13. 300 HOUR/12 MONTH INSPECTION — PART B (CONT)

DATA REFERENCE	INSPECTION TASK DESCRIPTION	INITIAL	
		MECH	OTHER
Chapter 53	<p><u>FUSELAGE — CABIN</u></p> <p>1. Forward fuselage:</p> <ul style="list-style-type: none"> a. Cabin exterior structure for corrosion and damage. b. Cabin interior structure for corrosion and damage. c. Ensure all drain holes are open. d. All compartments for evidence of water entrapment and corrosion. 		
Chapter 52	<p>2. Doors and windows:</p> <ul style="list-style-type: none"> a. Crew doors structure for corrosion, damage, distortion, and positive locking mechanisms. Seals for tears and separations. b. Crew door emergency jettison mechanism for condition and security. Perform operational check. c. Passenger door structure for corrosion, damage, distortion, and positive locking mechanisms. d. Nose, electrical, and equipment compartment access doors for corrosion, damage, distortion, and positive locking mechanisms. e. Passenger door window retainers and fillers for damage. Seals for adherence, tears, separations, and deterioration. f. If installed, inspect heated windshield for condition and proper installation. 		
Chapter 67	<p>3. Collective flight control actuator:</p> <ul style="list-style-type: none"> a. Universal bearings for looseness. b. Input lever bearings and bolts for wear and looseness. 		

SCHEDULED INSPECTIONS

5-13. 300 HOUR/12 MONTH INSPECTION — PART B (CONT)

DATA REFERENCE	INSPECTION TASK DESCRIPTION	INITIAL	
		MECH	OTHER
BHT-ALL-SPM	<p>c. Fasteners attaching cylinder lower supports to structure for looseness.</p> <p>d. Cylinder lower bearings for looseness.</p> <p>e. Actuator assembly for damage and leakage.</p> <p>f. Cylinder extension tube for condition and security.</p> <p>g. Actuator linkage, balance spring, and bracket for wear and security.</p> <p>h. Clean exposed area of actuator piston with hydraulic fluid and a clean lint-free cloth.</p> <p>i. Check hydraulic cylinder piston rod for evidence of excessive wear and scoring. Wear of the piston rod indicates cylinder assembly is incorrectly aligned to lower support and requires adjustment.</p> <p>j. Remove bolts attaching actuator to lower supports. Check cylinder alignment to lower support. Rod end bearing side loads are not permitted. Install bolts.</p> <p>k. Torque check nuts attaching actuator cylinder to upper supports.</p> <p>l. Upper cylinder housing mounting bracket cavity for corrosion. Cavity drain hole for obstruction. Reapply corrosion preventive compound (C-104) as required. Dust boot for condition.</p>		
Chapter 67	<p>4. Collective control tubes:</p> <p>a. Control tubes between collective jackshaft and collective control actuator pilot valve input lever for corrosion, wear, and damage.</p> <p>b. Control tube bellcrank, supports, and attaching hardware for corrosion, wear, and damage.</p>		

SCHEDULED INSPECTIONS

5-13. 300 HOUR/12 MONTH INSPECTION — PART B (CONT)

DATA REFERENCE	INSPECTION TASK DESCRIPTION	INITIAL	
		MECH	OTHER
Chapter 67	<p>5. Cyclic flight control actuators:</p> <ul style="list-style-type: none"> a. Universal bearings for looseness. b. Input lever bearings and bolts for wear and looseness. c. Fasteners attaching cylinder lower supports to structure for looseness. d. Cylinder lower bearings for looseness. e. Actuator assembly for damage and leakage. f. Cylinder extension tube for condition and security. g. Actuator linkage for wear and security. h. Clean exposed area of actuator piston with hydraulic fluid and a clean lint-free cloth. i. Check hydraulic cylinder piston rod for evidence of excessive wear and scoring. Wear of the piston rod indicates cylinder assembly is incorrectly aligned to lower support and requires adjustment. j. Remove bolts attaching actuator to lower supports. Check cylinder alignment to lower support. Rod end bearing side loads are not permitted. Install bolts. k. Torque check nuts attaching actuator cylinder to upper supports. 		
BHT-ALL-SPM	<ul style="list-style-type: none"> l. Upper cylinder housing mounting bracket cavity for corrosion. Cavity drain hole for obstruction. Re-apply corrosion preventive compound (C-104) as required. Dust boot for condition. 		

SCHEDULED INSPECTIONS

5-13. 300 HOUR/12 MONTH INSPECTION — PART B (CONT)

DATA REFERENCE	INSPECTION TASK DESCRIPTION	INITIAL	
		MECH	OTHER
Chapter 67	<p>6. Cyclic control tubes:</p> <p>a. Control tubes between cyclic jackshaft and cyclic control actuator pilot valve input lever for corrosion, wear, and damage.</p> <p>b. Control tube bellcranks, mixing levers, supports, and attaching hardware for corrosion, wear, and damage.</p>		
Chapter 63	<p>7. Transmission:</p> <p>a. All transmission chip detectors for debris.</p> <p>b. Clean all transmission chip detectors.</p> <p>c. Test all transmission chip detector electrical circuits.</p> <p>d. Transmission internal oil filter or full flow oil debris monitor for debris.</p> <p>e. Clean transmission internal oil filter or full flow oil debris monitor.</p> <p>f. Move pylon fore and aft, using mast as lever. Check friction dampers for freedom of movement and smooth operation.</p> <p>g. Mounts for damage and security.</p> <p>h. Lift link and attachments for corrosion, damage, and security. Bearings for looseness.</p> <p>i. Mast torque sensor (if installed) installation for condition and security.</p>		
BHT-412-CR&O	<p>j. Torque check: top case to ring gear case nuts, ring gear case to main case nuts and main case to support case nuts 230 to 250 inch-pounds (25.99 to 28.25 Nm). Re-torque as required.</p>		

SCHEDULED INSPECTIONS

5-13. 300 HOUR/12 MONTH INSPECTION — PART B (CONT)

DATA REFERENCE	INSPECTION TASK DESCRIPTION	INITIAL	
		MECH	OTHER
Chapter 32	<p>8. Landing gear assembly:</p> <p style="padding-left: 40px;">a. Landing gear skid shoes for excessive wear, cracks, damage, corrosion, and security of attachment.</p> <p style="padding-left: 40px;">b. Aft cross tube support beam for cracks, damage, corrosion, and security of attachment.</p> <p style="padding-left: 40px;">c. Retighten cross tube to skid tube saddle bolts.</p> <p style="padding-left: 40px;">d. Torque forward and aft cross tube support fittings U-bolts to 80 to 100 inch-pounds (9.04 to 11.29 Nm).</p> <p style="padding-left: 40px;">e. Torque check ground handling wheel attachment eyebolts on skid tubes 40 to 58 foot-pounds (54 to 79 Nm). Eyebolts that rotate prior to reaching 40 foot-pounds (54 Nm) shall be removed and inspected for evidence of bending. No bending is permitted.</p>		
BHT-412-SI-58	<p style="padding-left: 40px;">f. If gross weight towing kit provisions are installed, inspect fitting assembly for condition and security. Torque check attachment bolts 160 to 190 inch-pounds (18.1 to 21.4 Nm). If bolts are found loose, inspect for condition.</p>		
Chapter 53	<p>9. Underside of fuselage:</p> <p style="padding-left: 40px;">a. Fuselage structure for damage, corrosion, and working rivets.</p> <p style="padding-left: 40px;">b. Exterior finish for condition and cleanliness.</p> <p style="padding-left: 40px;">c. Evidence of excessive fluid leakage.</p> <p style="padding-left: 40px;">d. Structure around landing gear for condition.</p> <p style="padding-left: 40px;">e. Forward crosstube support structure for working fasteners, cracks, corrosion, and excessive wear.</p> <p style="padding-left: 40px;">f. Aft crosstube support structure for working fasteners, cracks, corrosion, and excessive wear.</p>		

SCHEDULED INSPECTIONS

5-13. 300 HOUR/12 MONTH INSPECTION — PART B (CONT)

DATA REFERENCE	INSPECTION TASK DESCRIPTION	INITIAL MECH OTHER	
<p>Chapter 71</p> <p>Chapter 71</p> <p>Chapter 71</p> <p>Chapter 71</p>	<p><u>FUSELAGE AFT OF CABIN LEFT AND RIGHT SIDE</u></p> <p style="text-align: center;">NOTE</p> <p>Refer to the applicable Pratt & Whitney Canada Engine Maintenance Manual for engine inspection requirements.</p> <p>1. No. 1 (left) engine power section:</p> <p style="padding-left: 20px;">a. Chip detectors for debris.</p> <p style="padding-left: 20px;">b. Clean chip detectors.</p> <p style="padding-left: 20px;">c. Test chip detector electrical circuits.</p> <p>2. No. 2 (right) engine power section:</p> <p style="padding-left: 20px;">a. Chip detectors for debris.</p> <p style="padding-left: 20px;">b. Clean chip detectors.</p> <p style="padding-left: 20px;">c. Test chip detector electrical circuits.</p> <p>3. Reduction (combining) gearbox:</p> <p style="padding-left: 20px;">a. Chip detector for debris.</p> <p style="padding-left: 20px;">b. Clean chip detector.</p> <p style="padding-left: 20px;">c. Test chip detector electrical circuits.</p> <p>4. Engine electrical connections:</p> <p style="padding-left: 20px;">a. Power section 1 ignition leads for corrosion, chafing, and security.</p> <p style="padding-left: 20px;">b. Power section 2 ignition leads for corrosion, chafing, and security.</p>		



SCHEDULED INSPECTIONS

5-13. 300 HOUR/12 MONTH INSPECTION — PART B (CONT)

DATA REFERENCE	INSPECTION TASK DESCRIPTION	INITIAL	
		MECH	OTHER
Chapter 71	<p>5. Starter generator:</p> <p>a. Power section 1 starter generator brushes for allowable wear.</p> <p>b. Power section 2 starter generator brushes for allowable wear.</p> <p>c. Power section 1 starter generator cooling ducts for obstruction, kinking, and security.</p> <p>d. Power section 2 starter generator cooling ducts for obstruction, kinking, and security.</p> <p style="text-align: center;">NOTE</p> <p>If applicable, refer to BHT-412-SI-87 for installation of adjustable seals or refer to Chapter 71 for seal adjustment.</p>		
Chapter 71 ASB 412-10-140	6. Inspect the left side and right side engine air inlet cowlings for gaps between the lower surface of the cowling firewall and the mating horizontal engine firewall.		
Chapter 76	<p>7. Engine fuel and power controls:</p> <p>a. Engine control linkages for looseness, lost motion, chafing, damage, and security of attachment.</p> <p>b. Bellcranks, mounts, and jackshafts for looseness, damage, and security of attachment.</p> <p>c. Check controls for smooth movement throughout full range of travel.</p> <p>d. Perform engine fuel control check (not applicable to PT6T-9 engine).</p>		
BHT-412-FM			
Chapter 26	<p>8. Engine fire detection systems for condition and security.</p> <p style="text-align: center;"><u>TAILBOOM</u></p>		
Chapter 53	1. Tailboom structure:		



SCHEDULED INSPECTIONS

5-13. 300 HOUR/12 MONTH INSPECTION — PART B (CONT)

DATA REFERENCE	INSPECTION TASK DESCRIPTION	INITIAL	
		MECH	OTHER
ASB 412-90-49	<p>a. Tailboom exterior structure for corrosion and damage.</p> <p>b. Tailboom interior structure for corrosion and damage.</p> <p>c. Inspect tailboom joints, splices, longerons, attach fittings, and attaching hardware for corrosion, damage, and cracks.</p> <p>d. Remove plug button at BS 99.00.</p> <p style="text-align: center;">NOTE</p> <p>Paint fissures are common in the splice area, cracks will be evident by black powder emanating from cracked area, corrosion will leave evidence of white powder.</p> <p>e. Using a borescope or other suitable means, inspect inside of longeron paying particular attention to cracking and/or corrosion in area of splice.</p> <p>f. Report any cracks to Product Support Engineering.</p> <p>g. Install plug button with sealant (C-308).</p> <p>h. Ensure all drain holes are open.</p> <p>i. Vertical fin spar caps forward side and web from upper tailboom skin to approximately 4.0 inches (102 mm) below upper tailboom skin as follows: remove aft tailboom access door. Face aft and use bright light and small mirror to inspect area for cracks, especially near rivet holes.</p>		
BHT-ALL-SPM	<p style="text-align: center;">NOTE</p> <p>If necessary, clean area with cloth dampened with MEK (C-309) or equivalent. Ventilate area to prevent breathing fumes.</p>		
Chapter 67	<p>2. Antitorque controls:</p> <p>a. Tail rotor control tubes between tail rotor pedals and tail rotor gearbox for corrosion, wear, and damage.</p>		



SCHEDULED INSPECTIONS

5-13. 300 HOUR/12 MONTH INSPECTION — PART B (CONT)

DATA REFERENCE	INSPECTION TASK DESCRIPTION	INITIAL	
		MECH	OTHER
ASB 412-15-166	<p>b. Control tube bellcranks, supports, and attaching hardware for corrosion, security, wear, and damage.</p> <p>c. Tail rotor hydraulic actuator for leaks and security of attachment, damage, corrosion, and bearings and linkages for looseness.</p> <p>d. Disconnect both ends of control tube 212-001-055-101 from bellcranks 212-001-705-001 and 212-001-759-101.</p> <p>(1) Without removing control tube 212-001-055-101, visually inspect control tube for cracks. No cracks permitted.</p> <p>(2) On bellcranks 212-001-705-001 and 212-001-759-101, inspect bearings DAS-14A1-512 for freedom of movement, bearings shall move freely in all directions and rotate freely. If a defective bearing is found, replace defective bearing in accordance with BHT-ALL-SPM.</p>		
Chapter 67	<p>3. Aerodynamically actuated elevator:</p> <p>a. Elevator control tube between forward support bracket and elevator horn for corrosion, wear, and damage.</p> <p>b. Control tube support and attaching hardware for security, corrosion, wear, and damage.</p> <p>c. Elevators and support structure for loose or missing rivets and cracks in the skin.</p> <p>d. Trailing edge tabs and tip caps for condition and security.</p> <p>e. Functionally check operation of tube as follows:</p> <div style="text-align: center;"> <p>CAUTION</p> </div> <p>DO NOT RELEASE ELEVATOR AND ALLOW THE SPRING TO DRIVE ELEVATOR BACK TO ORIGINAL POSITION.</p>		

SCHEDULED INSPECTIONS

5-13. 300 HOUR/12 MONTH INSPECTION — PART B (CONT)

DATA REFERENCE	INSPECTION TASK DESCRIPTION	INITIAL	
		MECH	OTHER
	<p>(1) Move elevator to extreme nose down position and while holding allow elevator to slowly return to original position. Failure to return to original position, binding and/or lock-up are not acceptable.</p> <p>(2) If any of these conditions exist, replace tube.</p> <p>f. Remove elevator control tube and measure spring breakout force for 90 to 100 pounds (400.32 to 444.80 N). Install elevator control tube.</p> <p>g. Functionally check elevator rigging for proper setting and travel.</p> <p>h. Inspect and measure elevator trailing edge tab for 16° ±1/4° angle down from upper surface of elevator.</p>		
Chapter 52	4. Baggage compartment door for corrosion, damage, distortion, and positive locking mechanism.		
Chapter 26	5. Baggage compartment smoke detector for condition and security.		
Chapter 96	6. Inspect wire bundles and clamping for chafing, condition, and security.		
	NOTE		
	Step 7 pertains to helicopters S/N 33001 through 33213 and S/N 36001 through 36019 not modified by 412-570-001-103 or Pre BHT-412-SI-74 (412SP to 412HP Upgrade).		
Chapter 65	7. Tail rotor driveshaft: <p>a. Hanger assemblies for cracks at mounting ears, corrosion, and security of attachment.</p> <p>b. Hanger supports for condition and security of attachment.</p> <p>c. Driveshaft sections and attaching hardware for condition and security.</p>		

SCHEDULED INSPECTIONS

5-13. 300 HOUR/12 MONTH INSPECTION — PART B (CONT)

DATA REFERENCE	INSPECTION TASK DESCRIPTION	INITIAL	
		MECH	OTHER
Chapter 65	<p>d. Coupling clamps for cracks in or near bolt lugs. Clamps for proper position.</p> <p style="text-align: center;">NOTE</p> <p>Step 8 pertains to helicopters S/N 36020 through 36999, S/N 37002 through 37999, S/N 38001 through 38999, S/N 39101 through 39999, and helicopters modified by 412-570-001-103 or Post BHT-412-SI-74 (412SP to 412HP Upgrade).</p> <p>8. Tail rotor driveshaft:</p> <p>a. Hanger assemblies for cracks at mounting ears, corrosion, and security of attachment.</p> <p>b. Hanger supports for condition and security of attachment.</p> <p>c. Driveshaft sections and attaching hardware for condition and security.</p> <p>d. Disc pack couplings and attaching hardware for condition and security.</p> <p style="text-align: center;">NOTE</p> <p>Step 9 and step 10 do not pertain to helicopters S/ N 37002 through 37999, S/N 38001 through 38999, and S/N 39101 through 39999.</p>		
Chapter 65	<p>9. Intermediate gearbox:</p> <p>a. Chip detector for debris.</p> <p>b. Clean chip detector.</p> <p>c. Functionally test chip detector electrical circuit.</p>		
Chapter 12	<p>d. Service gearbox as required.</p>		

SCHEDULED INSPECTIONS

5-13. 300 HOUR/12 MONTH INSPECTION — PART B (CONT)

DATA REFERENCE	INSPECTION TASK DESCRIPTION	INITIAL	
		MECH	OTHER
Chapter 65	<p>10. Tail rotor gearbox:</p> <ul style="list-style-type: none"> a. Chip detector for debris. b. Clean chip detector. c. Functionally test chip detector electrical circuit. d. Service gearbox as required. 		
Chapter 64	<p>11. Tail rotor hub and blade assembly:</p> <ul style="list-style-type: none"> a. Dynamically balance tail rotor. b. Torque check nuts on tail rotor blade retention bolts. c. Torque check tail rotor retaining nut. <p><u>CABIN ROOF</u></p>		
Chapter 18			
Chapter 52 Chapter 53	<p>1. Cabin roof structure:</p> <ul style="list-style-type: none"> a. Cabin roof structure, cowlings and fairings for damage, delamination, and general condition. b. Cabin roof and cowling/fairing mounted antennas for condition and security. 		
Chapter 62	<p>2. Main rotor hub and blade assembly:</p> <ul style="list-style-type: none"> a. Main rotor blades upper and lower surfaces for condition of bond lines and doublers. Leading edge for erosion. Blade surfaces for corrosion, cracks, damage, and voids. b. Main rotor hub assembly for corrosion and damage. c. Blade retention bolts for condition and security. d. Torque check eight main rotor yoke assembly through bolt nuts to 70 to 80 foot-pounds (95 to 108 Nm). 		

SCHEDULED INSPECTIONS

5-13. 300 HOUR/12 MONTH INSPECTION — PART B (CONT)

DATA REFERENCE	INSPECTION TASK DESCRIPTION	INITIAL	
		MECH	OTHER
Chapter 62	<p>e. Ensure bolts EWB0420 are installed (16 places) for simple pendulum absorber bracket. Torque check bolts. Apply 29 to 33 foot-pounds (39 to 45 Nm) in increasing torque direction.</p> <p>3. Main rotor controls:</p> <p>a. Torque check swashplate link elastomeric rod end bearings (as applicable) attachment bolts 165 to 200 inch-pounds (18.65 to 22.59 Nm).</p> <p>b. Torque check swashplate outer ring through bolts to 165 to 175 inch-pounds (18.65 to 19.77 Nm).</p> <p>c. Torque check four hub and sleeve to rephasing lever attachment bolts to 24 to 34 foot-pounds (33 to 46 Nm) for 1/2 inch (13 mm) bolts or to 160 to 200 inch-pounds (18.08 to 22.59 Nm) for 3/8 inch bolts (if installed).</p> <p>d. Torque check four drive link to rephasing lever attachment bolts to 165 to 200 inch-pounds (18.65 to 22.59 Nm).</p> <p>e. Torque check pitch link elastomeric rod end bearings (as applicable) attachment bolts to 165 to 200 inch-pounds (18.65 to 22.59 Nm).</p> <p>f. Torque check swashplate support to mast plate bolts AN5H-6A to 130 to 140 inch-pounds (14.69 to 15.81 Nm).</p>		
Chapter 96	<p>4. Emergency bus interconnect circuit breaker and diodes:</p> <p style="text-align: center;">NOTE</p> <p>Helicopters S/N 33001 through 33107, except those modified for CAA, remove screw, spacer, and washer installed in the emergency load switch guard.</p> <p>a. Inspect EMERG BUS INTC circuit breaker for wear. Operate circuit breaker manually and check by feel. Worn or loose circuit breaker is not acceptable. Close circuit breaker.</p>		

SCHEDULED INSPECTIONS

5-13. 300 HOUR/12 MONTH INSPECTION — PART B (CONT)

DATA REFERENCE	INSPECTION TASK DESCRIPTION	INITIAL MECH OTHER	
Chapter 96	<p>b. Place all switches in OFF or NORM position and close all circuit breakers.</p> <p>c. Connect battery.</p> <p>d. Place BATTERY BUS 1 switch and BATTERY BUS 2 switch in the ON position. Position INV 1 and INV 2 switches in the ON position. Caution panel INVERTER 1 and INVERTER 2 segments should not be illuminated.</p> <p>e. Check emergency bus power by pressing the FIRE EXT PRESS TO TEST button momentarily. Observe both FIRE PULL handle warning lights illuminate.</p> <p>f. Position emergency bus switch to EMERG LOAD position. Check emergency bus power by pressing the FIRE EXT PRESS TO TEST button momentarily. Observe both FIRE PULL handles illuminate. Verify INVERTER 1 and INVERTER 2 segments are illuminated on the caution panel.</p> <p style="text-align: center;">NOTE</p> <p>S/N 33108 through 33213 and 36001 through 36999 — Check INVERTER 1 light segment on the caution panel is not illuminated and INVERTER 2 segment is illuminated.</p> <p>g. Position BATTERY BUS 1 and BATTERY BUS 2 switches off. Check emergency bus power by pressing FIRE EXT PRESS TO TEST button momentarily. Observe FIRE PULL handles illuminate.</p> <p>h. Position INVERTER 1 and INVERTER 2 switches OFF. Position emergency bus switch to NORMAL. Disconnect battery.</p> <p>i. Install screw, spacer, and washer in the emergency load switch guard if removed.</p> <p>5. Perform functional check of power diodes.</p>		

SCHEDULED INSPECTIONS

5-14. 600 HOUR/12 MONTH INSPECTION — PART B

DATA REFERENCE	INSPECTION TASK DESCRIPTION	INITIAL MECH OTHER	
	<p>DATE: _____ W.O. _____</p> <p>FACILITY: _____</p> <p>HELICOPTER S/N: _____</p> <p>REGISTRY NO.: _____</p> <p>TOTAL TIME: _____</p> <p>SIGNATURE: _____</p> <p style="text-align: center;">NOTE</p> <p>For helicopters on the Part B inspection program, accomplish the following checks each 600 hours of flight operation or 12 calendar months, whichever occurs first.</p> <p><u>GENERAL</u></p> <p>Each listed inspection item or maintenance function is to be performed in accordance with the BHT-412-MM chapter specified.</p> <p><u>PRELIMINARY REQUIREMENTS</u></p> <ol style="list-style-type: none"> 1. All work accomplished during inspection shall be recorded in helicopter maintenance records. 2. Remove all fuselage and tailboom access panels, removable floor panels, fairings, and cowlings. 3. Ensure all applicable Special Inspections, Alert Service Bulletins, and Airworthiness Directives have been accomplished. 		

SCHEDULED INSPECTIONS

5-14. 600 HOUR/12 MONTH INSPECTION — PART B (CONT)

DATA REFERENCE	INSPECTION TASK DESCRIPTION	INITIAL	
		MECH	OTHER
	<p><u>AFTER COMPLETION OF INSPECTION</u></p> <p>1. Reinstall all panels, fairings, and cowlings removed during inspection.</p> <p>2. Carry out a ground run and leak check prior to releasing the helicopter back to service.</p> <p><u>FUSELAGE</u></p>		
Chapter 25	<p>1. Emergency and safety equipment:</p> <p style="padding-left: 40px;">a. Emergency and safety equipment for inspection due dates.</p> <p style="padding-left: 40px;">b. Contents of first aid kit for missing or over age items.</p>		
Chapter 26	<p>2. Perform weight check of cockpit and cabin portable fire extinguishers.</p>		
Chapter 52	<p>3. Perform operational check of crew doors emergency release mechanisms.</p>		
Chapter 21 Chapter 96	<p>4. Bleed air heating and ventilation/defog system components:</p> <p style="padding-left: 40px;">a. Perform functional check of bleed air heating system and components.</p> <p style="padding-left: 40px;">b. Perform functional check of defog blower.</p>		
Chapter 95	<p>5. Instruments: (required at 12 months calendar time only)</p> <p style="padding-left: 40px;">a. Calibrate pilot, copilot compass systems, and standby magnetic compass.</p> <p style="padding-left: 40px;">b. Drain pitot-static system of any accumulated moisture.</p> <p style="padding-left: 40px;">c. Test pitot-static system for leaks.</p>		
Chapter 96	<p>6. Perform functional check of battery temperature sensor caution light system.</p>		

SCHEDULED INSPECTIONS

5-14. 600 HOUR/12 MONTH INSPECTION — PART B (CONT)

DATA REFERENCE	INSPECTION TASK DESCRIPTION	INITIAL	
		MECH	OTHER
Chapter 67	<p>7. Collective flights controls:</p> <ul style="list-style-type: none"> a. Inspect flight control systems bellcrank and control tubes for damage, chafing, corrosion, and security of attachment. b. Inspect friction shoes and liners for condition. c. Check collective lever friction adjuster for operation. d. Check for proper collective minimum friction. e. Check collective flight controls for smooth movement throughout full range of travel. <p>8. Cyclic flight controls:</p> <ul style="list-style-type: none"> a. Inspect flight control systems bellcrank and control tubes for damage, chafing, corrosion, and security of attachment. b. Check cyclic stick friction adjuster for proper operation. c. Check for proper cyclic minimum friction. d. Check cyclic flight controls for smooth movement throughout full range of travel. <p>9. Anti-torque flight controls:</p> <ul style="list-style-type: none"> a. Flight control systems bellcrank and control tubes for damage, chafing, corrosion, and security of attachment. b. Check anti-torque friction adjuster for proper friction. c. Check anti-torque flight controls for smooth movement throughout full range of travel. 		



SCHEDULED INSPECTIONS

5-14. 600 HOUR/12 MONTH INSPECTION — PART B (CONT)

DATA REFERENCE	INSPECTION TASK DESCRIPTION	INITIAL	
		MECH	OTHER
Chapter 76 Pratt & Whitney Canada PT6T-3 Series Maintenance Manual	<p>10. Engine: Perform maximum N_G topping check.</p> <p style="text-align: center;">NOTE</p> <p>Maximum N_G topping check is not applicable to Pratt & Whitney PT6T-9 engine.</p>		
Chapter 76	<p>11. Engine controls:</p> <p style="padding-left: 40px;">a. Check collective lever throttle friction adjusters for proper operation.</p>		
Chapter 28 Chapter 71	<p>12. Inspect all exposed fuel lines and attachments for leakage, damage, and security.</p>		
Chapter 29	<p>13. Hydraulic system:</p> <p style="text-align: center;">NOTE</p> <p>Hydraulic filter elements 205-076-034-003 are non-cleanable. It is recommended they be replaced every 600 hours or 12 months. Filter elements 205-076-034-007 are cleanable. The 212-076-006-007 assembly must have -007 element only. The -003 and -007 elements are interchangeable on the assembly 212-076-006-105; intermixing of different element types is not permitted.</p> <p style="padding-left: 40px;">a. Remove and inspect hydraulic filter elements.</p> <p style="padding-left: 40px;">b. Discard or clean filter elements as applicable.</p> <p style="padding-left: 40px;">c. Install hydraulic filter elements.</p>		
Chapter 63	<p style="padding-left: 40px;">d. Install 0 to 500 PSI (0 to 3447 kPa) gauge in quick disconnect at rotor brake caliper. Slowly pull rotor brake handle through travel. Cylinder should generate 240 to 260 PSI (1655 to 1793 kPa) at any handle velocity and shall maintain 150 PSI (1034 kPa) minimum in over center position for 3 minutes. Adjust as necessary.</p>		

SCHEDULED INSPECTIONS

5-14. 600 HOUR/12 MONTH INSPECTION — PART B (CONT)

DATA REFERENCE	INSPECTION TASK DESCRIPTION	INITIAL	
		MECH	OTHER
Chapter 53	<p>e. Inspect brake linings for wear (minimum thickness 0.150 inch (3.81 mm)).</p> <p>14. Fuselage cabin structure:</p> <p>a. Fuselage structure for corrosion and damage to finish and sealant. Pay particular attention to edges of joints and seams and around fastener heads.</p> <p>b. Ensure all drain holes are open.</p> <p>c. Engine compartment floor and service deck, FS 155.06 to 241.22, for damage, delamination, and corrosion.</p> <p>d. Fuselage bonded panels for damage and delamination.</p> <p style="text-align: center;">NOTE</p> <p>To adequately inspect the following, it will be necessary to remove the auxiliary fuel tanks, if installed.</p> <p>e. Pylon wall for damage, working fasteners, cracks, delamination, and corrosion.</p>		
Chapter 96	<p>15. Electrical system:</p> <p>a. Check inverters for security of mounting and connections.</p> <p>b. Check generator control units for damage and security of mounting and terminals.</p> <p>c. Inspect all exposed wire bundles, bundle supports, and connectors for damage, corrosion, and security. Pay particular attention to engine deck connectors and harnesses.</p> <p>d. Inspect relays and main bus area for security of mounting and connections.</p> <p>e. Inspect bus insulation for damage and condition.</p>		

SCHEDULED INSPECTIONS

5-14. 600 HOUR/12 MONTH INSPECTION — PART B (CONT)

DATA REFERENCE	INSPECTION TASK DESCRIPTION	INITIAL	
		MECH	OTHER
Chapter 4 Chapter 26 Chapter 96	<p>16. Fire extinguishing system:</p> <p>a. Functionally check voltage of engine fire extinguishing circuits.</p> <p>b. Replace engine fire extinguisher container firing cartridges in accordance with specified service life.</p>		
ASB 412-12-152	<p>c. Visually inspect the loop clamp installed on modified discharge tubes 212-060-921-001FM and -002FM for condition and security until Part III of referenced ASB is accomplished.</p>		
Chapter 28	<p>17. Remove four access doors, located just forward of the aft crosstube, from the underside of the fuselage. Inspect fuel lines for evidence of leakage, damage, and security.</p>		
Chapter 62	<p>18. Swashplate and support assembly — hub and sleeve assembly:</p> <p>a. Disconnect drive and swashplate links from swashplate outer ring.</p> <p>b. Disconnect pitch links from main rotor hub pitch horns.</p> <p>c. Disconnect the collective pitch drive plate set.</p> <p>d. Check swashplate duplex bearing and collective sleeve hub bearing set for roughness and ease of rotation.</p> <p>e. Reconnect the collective pitch drive plate set.</p> <p style="text-align: center;">NOTE</p> <p>It is not necessary to check the shim thickness if the original collective pitch drive plate set is being reinstalled.</p> <p>f. Purge lubricate bearings.</p> <p>g. Reconnect drive and swashplate links and tubes.</p>		

SCHEDULED INSPECTIONS

5-14. 600 HOUR/12 MONTH INSPECTION — PART B (CONT)

DATA REFERENCE	INSPECTION TASK DESCRIPTION	INITIAL	
		MECH	OTHER
Chapter 53	<p style="text-align: center;">NOTE</p> <p>The following step is to be performed every 12 months.</p> <p>19. Inspect all fuel system, oil system, and hydraulic system filler caps for proper functioning and sealing. Make sure the sealing O-rings within the filler caps are in good condition. Repair or replace the filler caps or replace sealing O-rings as required.</p> <p><u>TAILBOOM</u></p> <p>1. Tailboom structure for corrosion and damage to finish and sealant. Pay particular attention to edges of joints and seams and around fastener heads.</p> <p style="text-align: center;">NOTE</p> <p>Step 2 and step 3 pertain to helicopters modified with the BLR FastFin™ system kit 412-705-040-101.</p> <p>For helicopters equipped with the Dual Tailboom Strakes and FastFin™ system Supplemental Type Certificate (STC), refer to the applicable BLR Aerospace documents for inspection criteria.</p>		
Chapter 26	<p>2. Inspect upper and lower tail fairings for visible damage to the exterior skin and cracks at the attachment points. If paint is missing locally or has scratches, inspect the fairing for delamination and voids with a tap hammer. Inspect fairings for loose or missing attaching hardware.</p>		
Chapter 67	<p>3. Inspect upper and lower strakes for visible damage, deformation, cracks at the attachment points, and loose or missing rivets.</p> <p>4. Functionally check baggage compartment smoke detector.</p> <p>5. Aerodynamically actuated elevator:</p> <p style="padding-left: 20px;">a. Remove left and right elevators.</p> <p style="padding-left: 20px;">b. Clean elevator spars and inspect for corrosion.</p>		

SCHEDULED INSPECTIONS

5-14. 600 HOUR/12 MONTH INSPECTION — PART B (CONT)

DATA REFERENCE	INSPECTION TASK DESCRIPTION	INITIAL	
		MECH	OTHER
	<p>c. Clean internal bore of elevator horn and inspect for corrosion.</p> <p>d. With elevator control removed, attach a spring scale to hole in arm of horn where control tube is normally installed. Pull scale at right angle to arm, verify friction is 26 to 32 pounds (115.65 to 142.34 N). If friction is not within limits, adjust shim thickness.</p> <p>e. Install left and right elevator.</p>		

SCHEDULED INSPECTIONS

5-15. 5000 HOUR/5 YEAR INSPECTION — PART B

DATA REFERENCE	INSPECTION TASK DESCRIPTION	INITIAL MECH OTHER	
	<p>DATE: _____ W.O. _____</p> <p>FACILITY: _____</p> <p>HELICOPTER S/N: _____</p> <p>REGISTRY NO.: _____</p> <p>TOTAL TIME: _____</p> <p>SIGNATURE: _____</p> <p style="text-align: center;">NOTE</p> <p>For helicopters on the Part B inspection program, accomplish the following checks each 5000 hours flight time or 60 months, whichever occurs first.</p> <p>This inspection is meant to be a full visual inspection of the airframe primarily for environmental damage and corrosion.</p> <p><u>GENERAL</u></p> <p>Each listed inspection item or maintenance function is to be performed in accordance with the BHT-412-MM chapter specified or the BHT-412-CR&O.</p> <p><u>PRELIMINARY REQUIREMENTS</u></p> <p>1. All work accomplished during this inspection shall be recorded in the helicopter maintenance records.</p> <p>2. Remove all panels, interior coverings, fairings, and cowlings required to satisfactorily carry out the inspection.</p>		

SCHEDULED INSPECTIONS

5-15. 5000 HOUR/5 YEAR INSPECTION — PART B (CONT)

DATA REFERENCE	INSPECTION TASK DESCRIPTION	INITIAL	
		MECH	OTHER
	<p>3. Remove the following items:</p> <ul style="list-style-type: none"> a. Main battery. b. Electrical and avionics equipment from the nose area, as required, to allow a full visual inspection of the nose area to be performed. c. Main rotor transmission. d. Intermediate gearbox. e. Tail rotor gearbox. f. Tailboom (to allow a full inspection of the aft fuselage bulkhead and forward tailboom bulkhead). g. Landing gear assembly (to allow a complete inspection of the landing gear attachment points and support structure). <p>4. In addition to the 5000 Hour/5 Year Inspection — Part B items, do the following:</p> <ul style="list-style-type: none"> a. Complete 25 Hour/30 Day Inspection — Part B. b. Complete 300 Hour/12 Month Inspection — Part B. c. Complete 600 Hour/12 Month Inspection — Part B. <p><u>AFTER COMPLETION OF INSPECTION</u></p> <p>1. Install the following items:</p> <ul style="list-style-type: none"> a. Main battery. b. Electrical and avionics equipment on the nose area. c. Main rotor transmission. d. Intermediate gearbox. e. Tail rotor gearbox. 		

SCHEDULED INSPECTIONS

5-15. 5000 HOUR/5 YEAR INSPECTION — PART B (CONT)

DATA REFERENCE	INSPECTION TASK DESCRIPTION	INITIAL	
		MECH	OTHER
Chapter 53	<p>f. Tailboom.</p> <p>g. Landing gear assembly.</p> <p>2. Install all panels, interior coverings, fairings, and cowlings removed during inspection.</p> <p>3. Do a ground run and leak check before you return the helicopter to service.</p> <p><u>FORWARD FUSELAGE</u></p> <p>1. Nose panels in area of pitot tube attachment, areas inside and outside for disbonding and cracking.</p> <p>2. Pitot tubes attachment for looseness.</p> <p>3. Nose shelves for damage, corrosion, and disbonding.</p> <p>4. Nose shelf attachment locations for damage, corrosion, and cracking.</p> <p>5. Right and left BL 14.00 main beams, forward of STA 23.00 for damage, corrosion, and cracking.</p> <p>6. Instrument panel attachment structure for damage, corrosion, and cracking, primarily in the door frame attachment area.</p> <p>7. Instrument panel glareshield for chafing and cracking.</p> <p>8. Crew door hinge attachment structure for damage and cracks.</p> <p>9. Outboard cabin post (1, Figure 5-4), cabin roof longeron (2), and windshield frame (5) upper corner area for damage and cracks.</p> <p>10. Striker plates (3 and 4) attachment areas for damage and cracks.</p> <p>11. Striker plates (3 and 4) for excessive wear, damage, and corrosion.</p>		

SCHEDULED INSPECTIONS

5-15. 5000 HOUR/5 YEAR INSPECTION — PART B (CONT)

DATA REFERENCE	INSPECTION TASK DESCRIPTION	INITIAL	
		MECH	OTHER
	<p>12. Cabin floor area under crew doors for chafing and damage.</p> <p>13. Crew door hinges for wear, damage, corrosion, and security of attachment.</p> <p>14. Crew doors for proper fit and operation.</p> <p>15. Crew seat rails for excessive wear and damage.</p> <p>16. Center and outboard bulkhead, below WL 22.00 at FS 23.00, for cracks, deformation, and corrosion along structure joints.</p> <p>17. Collective and cyclic control jackshafts support intercostals for cracks and corrosion.</p> <p>18. Cyclic support for corrosion and cracks.</p> <p>19. Collective, cyclic, and anti-torque control system bellcranks, levers, and support brackets for corrosion, cracks, and indication of wear at attaching points.</p> <p>20. Crew seat support beams, at BL 14.00 and 30.00 between FS 23.00 and 74.30, for cracks and corrosion.</p> <p>21. Forward crosstube attachment points and support structure at FS 63.33 and 74.30 for damage, corrosion, and cracks.</p> <p>22. Aft crosstube attachment points and support structure at FS 155.06 and 166.00 for damage, corrosion, and cracks.</p> <p>23. Crew and passenger cabin floor, FS 23.00 to 155.06, for corrosion and damage. Floor bonded panels for voids. Seat fasteners and cargo tie-down rings for condition. Area around pilot and copilot ICS foot switches for cracks.</p> <p style="text-align: center;">NOTE</p> <p style="text-align: center;">In the following step, removal of the fuel cells is not required unless there is evidence of fuel leakage or damage to the fuel cells or structure is suspected.</p>		

SCHEDULED INSPECTIONS

5-15. 5000 HOUR/5 YEAR INSPECTION — PART B (CONT)

DATA REFERENCE	INSPECTION TASK DESCRIPTION	INITIAL MECH OTHER	
	<p>24. All structure under floor panels and in forward fuel cell cavities including caps, angles, transverse bulkheads and bonded panels between FS 74.30 and 155.06 for damage, corrosion, cracks, and voids.</p> <p style="text-align: center;">NOTE</p> <p>In the following step, removal of the fuel cells is not required unless there is evidence of fuel leakage or damage to the fuel cells or structure is suspected. Structure that is hidden by the fuel cells only needs to be inspected if the fuel cells are removed for some reason or structural damage is suspected.</p> <p>25. All structure under floor panels and in aft fuel cell cavities including caps, angles, and panels between FS 155.06 and 200.00 for damage, corrosion, cracks, and voids.</p> <p>26. Bottom skin, FS 23.00 to 243.937, for damage. Joints for corrosion. Access panels and covers for condition and attachment.</p> <p>27. Main transmission compartment interior, FS 129.00 to 166.00 and WL 7.44 to 76.00, for corrosion. Bulkheads and main beam panels for damage and corrosion. Attaching supports and brackets for condition and security.</p> <p>28. Fluid lines in transmission compartment for evidence of leaks, condition, wear, and chafing. Clamps for condition (fluid contamination and swelling), and security of attachment.</p> <p>29. Lift beam fitting for condition and working rivets, lift link attachment bolt hole bores for excessive wear, and bushings for looseness.</p> <p>30. Pylon (transmission) support structure for wear and cracks. Pay particular attention to right and left horizontal supports, forward vertical supports, and aft vertical webs.</p> <p>31. Aft cabin bulkheads, FS 166.00, for damage, upper aft flange for cracks, and bulkhead panel for damage and disbonding.</p>		



SCHEDULED INSPECTIONS

5-15. 5000 HOUR/5 YEAR INSPECTION — PART B (CONT)

DATA REFERENCE	INSPECTION TASK DESCRIPTION	INITIAL	
		MECH	OTHER
	<p>32. Electrical/avionics compartment, FS 166.00 to 243.937, doors for condition and security. Door frames for cracks and corrosion. Compartment interior for condition and joints for corrosion. Skin for damage and cracks.</p> <p>33. Oil cooler compartment, FS 166.00 to 243.937, doors for condition and security. Main beam panels and bulkheads for condition and corrosion.</p> <p>34. Engine deck below the reduction gearbox, FS 211.00 to 238.00 for damage, cracks, and corrosion.</p> <p>35. Firewalls, FS 155.06 to 241.22, for damage, cracks, security of attachment, seals for condition, and seal attachment angles for cracks.</p> <p>36. Cabin roof, FS 35.00 to 166.00 above WL 68.00, BL 50.00 left and right side, for damaged skin and joints for corrosion, bonded panels for disbonding and corrosion. Structure above overhead console (circuit breaker panels) for cracks and corrosion.</p> <p>37. Cargo door tracks for wear, cracks, and corrosion.</p> <p>38. Engine and transmission cowlings and fairings for evidence of chafing, cracks, corrosion, and seals for condition.</p> <p>39. Bulkhead, FS 241.22, for damage, corrosion, and cracks. Tailboom attachment fittings for damage, cracks, and loose fasteners. Tailboom attachment bolt holes for damage and corrosion.</p> <p>40. Discard the upper left-hand attachment bolts. Carry out a detailed visual inspection of the remaining three attachment bolts for mechanical or corrosion damage. Any evidence of corrosion is cause for rejection.</p> <p>41. Apply a light coat of grease (C-561) or grease (C-172) on the shanks of the bolts only. Both threads are to remain dry.</p> <p>42. Install tailboom after completion of inspection with a new upper left-hand bolt and serviceable bolts at the three other locations.</p>		



SCHEDULED INSPECTIONS

5-15. 5000 HOUR/5 YEAR INSPECTION — PART B (CONT)

DATA REFERENCE	INSPECTION TASK DESCRIPTION	INITIAL	
		MECH	OTHER
Chapter 53	<p><u>TAILBOOM</u></p> <ol style="list-style-type: none"> 1. Bulkhead, BS 17.42, for corrosion and cracks. Fuselage attachment bolt holes for damage and corrosion. Barrel nuts for damage and corrosion. 2. Tailboom and fin driveshaft covers for condition and attachment. 3. Tailboom and fin external skin for damage, corrosion, and cracks. 4. Tailboom access panels and covers for condition and attachment. Tail rotor driveshaft cover hinges for wear. 5. Tailboom baggage compartment door for condition, attachment, and door handle operation. 6. Tailboom baggage compartment interior for damage, panels for disbonding, and corrosion. Longerons above roof panel for corrosion and cracks. Longerons below floor panel for corrosion and cracks. 7. Tailboom interior bulkheads and stringers for cracks and corrosion. 8. Intermediate gearbox mount pad for damage, cracks, fretting, and corrosion. 9. Tail rotor gearbox support fitting assembly for damage, cracks, fretting, and corrosion. Pay particular attention to mounting holes and lugs. 10. Tailboom exterior bonded panels adjacent to baggage compartment for damage, delamination, and corrosion. 11. With a borescope or equivalent, inspect interior structure of vertical fin for cracks, corrosion, fretting, and damage. 12. Control tube fairleads (grommets and guides) for wear and security of attachment. 		



SCHEDULED INSPECTIONS

5-15. 5000 HOUR/5 YEAR INSPECTION — PART B (CONT)

DATA REFERENCE	INSPECTION TASK DESCRIPTION	INITIAL	
		MECH	OTHER
	Deleted		



Figure 5-3. Deleted

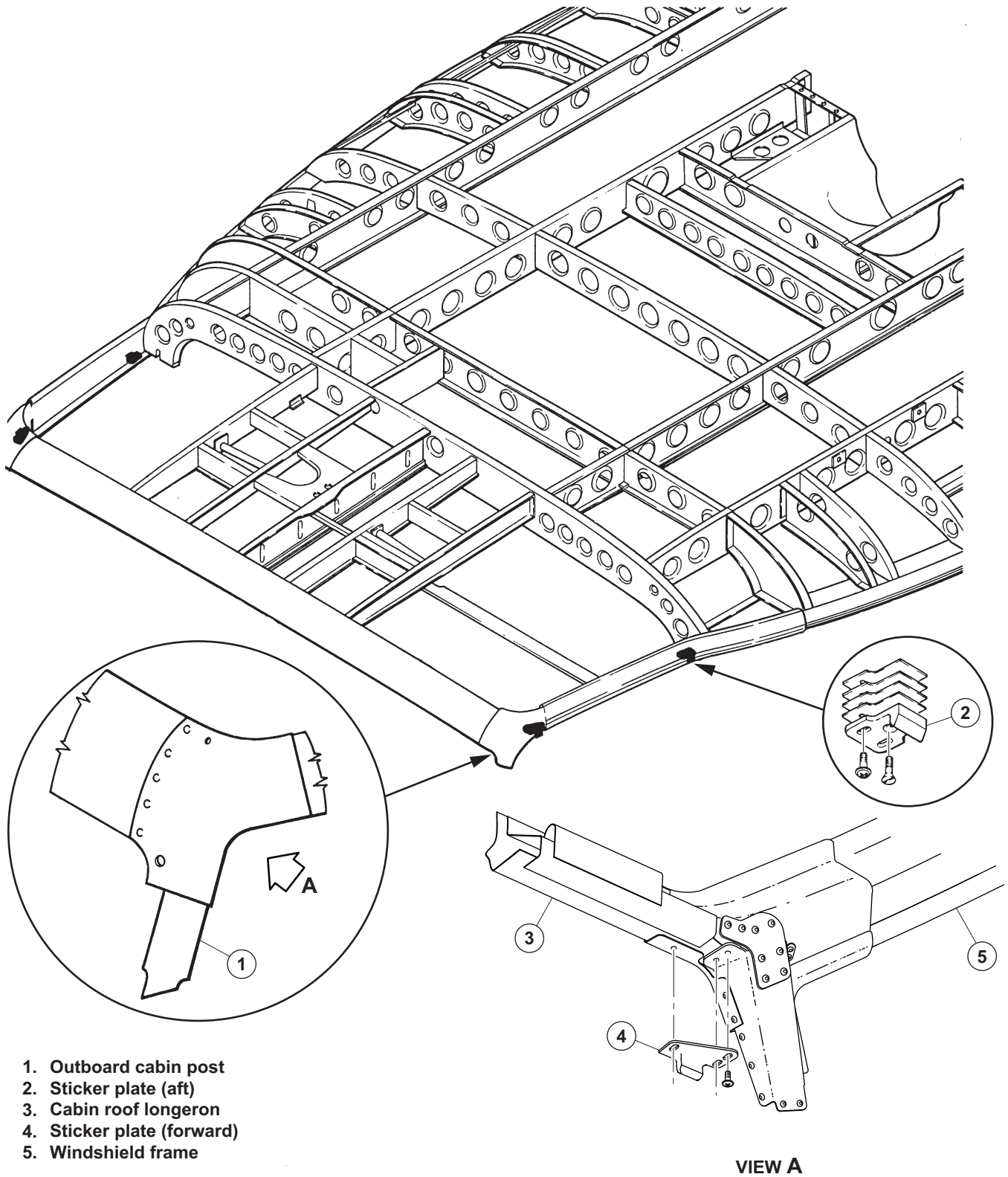

412_MM_05_0004+

Figure 5-4. Cabin Frame Inspection — Part B



SPECIAL INSPECTIONS

5-16. SPECIAL INSPECTION

Perform applicable special inspection of helicopter:

- Daily or each 10 hours, whichever occurs first until 250 hours.
- Between 1 and 5 flight hours after expandable blade bolt installation.
- Between 1 and 5 flight hours after main rotor hub installation.
- Between 5 and 10 hours of flight after each installation.
- Each 25 hours for the next four inspections.
- Each 25 hours of tail rotor operation.
- 50 hours after installation of components.
- 100 hours after installation of tailboom.
- Each 100 hours of collective lever operation.
- Each 150 hours of starter generator 200SG119Q operation.
- Each 300 hours or 6 months of expandable blade bolt operation.
- Each 600 hours of tail rotor driveshaft operation or 12 months, whichever occurs first.
- Each 600 hours of main driveshaft operation or 12 months, whichever occurs first.
- Each 1000 hours of component operation.
- Each 12 months or 2500 landings of aft high crosstube operation.
- Each 24 months of control bolt operation.
- Each 24 months of main rotor mast operation.
- Each 2500 hours of main rotor hub assembly operation.
- Each 2500 hours of main rotor blade operation.
- Each 2500 or 3000 hours of main rotor mast (412-040-366-109 and subsequent) operation.
- Each 2500 hours of tail rotor drive system operation.
- Each 3000 hours of main rotor mast (412-040-366-103, -105) operation.
- Each 3000 hours of transmission (412-040-002) operation.
- Each 3000 hours of transmission (412-040-004) operation.
- 3600 hours total airframe time and each 300 hours or 12 months, whichever occurs first thereafter.

Use the following time frame criteria when accomplishing the required maintenance manual torque checks after installation of components.

For additional information, refer to the BHT-ALL-SPM. If any confusion exists, or a clarification is desired, contact Product Support Engineering.

NOTE

Torque check is the term used when the specified torque or standard torque plus tare torque is applied to a fastener, in a tightening direction. The specified or standard torque plus tare torque would have to be previously recorded. However, if the specified or standard torque and tare were not recorded, use the minimum specified or standard torque, plus the tare torque listed in the BHT-ALL-SPM, Chapter 2.

Looseness may occur until components seat themselves and fasteners require tightening. This is not cause for disassembly, however the fastener must be torque checked again at the same scheduled interval set for the first torque check until the assembly is completely seated.

MANUAL SPECIFIES	SUGGESTED TIME FRAME TO ACCOMPLISH
100 hours	90 to 110 hours
50 hours	40 to 60 hours
25 hours	20 to 30 hours
10 hours	5 to 15 hours

SPECIAL INSPECTIONS

5-17. DAILY/10 HOUR INSPECTION, WHICHEVER OCCURS FIRST UNTIL 250 HOURS

DATA REFERENCE	INSPECTION TASK DESCRIPTION	INITIAL	
		MECH	OTHER
ASB 412-89-42	<p>DATE: _____ W.O. _____</p> <p>FACILITY: _____</p> <p>HELICOPTER S/N: _____</p> <p>REGISTRY NO.: _____</p> <p>TOTAL TIME: _____</p> <p>SIGNATURE: _____</p> <p style="text-align: center;">NOTE</p> <p>Accomplish daily or each 10 hours, whichever occurs first until 250 hours, on transmissions with affected gears having 50 hours or more.</p> <p><u>SPIRAL BEVEL GEAR (204-040-701-103)</u></p> <p>Affected helicopter S/N 33001 through 33138, 33150 through 33160, 33168 through 33175, 33177, 33178, 33179, 33181, 33182, 33185, 33186, and 33192.</p>		

SPECIAL INSPECTIONS

5-17. DAILY/10 HOUR INSPECTION, WHICHEVER OCCURS FIRST UNTIL 250 HOURS (CONT)

DATA REFERENCE	INSPECTION TASK DESCRIPTION	INITIAL MECH OTHER	
	<p>Spare (uninstalled) spiral bevel gears 04-040-701-103, affected serial numbers:</p> <p>A-3819, A-3821, A-3825, A-3826, A-3829, A-3833, A-3836, A-3834, A-3838, A-3840, A-3847, A-3848, A-3850, A-3855, A-3856, A-3857, A-3858, A-3861, A-3878, A-3880, A-3885, A-3886, A-3889, A-3891, A-3892, A-3893, A-3895, A-3896, A-3897, A-3899, A-3901, A-3911, A-3915, A-3916, A-3919, A-3920, A-4008, A-4014, A-4017, A-4019, A-4020, A-4021, A-4027, A-4029, A-4068, A-4069, A-4071, A-4075, A-4077, A-4079, A-4080, A-4081, A-4083, A-4084, A-4085, A-4087, A-4089, A-4090, A-4091, A-4092, A-4093, A-4094, A-4095, A-4096, A-4097, A-4098, A-4107, A-4108, A-4109, A-4147, A-4184, A-4187, A-4188, A-4191, A-4192, A-4193, A-4213, A-4233, A-4235, A-4236, A-4241, A-4243, A-4244, A-4245, A-4254, A-4266, A-4267, A-4274, A-4275, A-4280, A-4282, A-4288, A-4289, A-4290, A-4303, A-4319, A-4320, A-4325, A-4327, A-4328, A-4329, A-4332, A-4333, A-4334, A-4335, A-4336, A-4337, A-4358, A-4366, A-4368, A-4369, A-4370, A-4371, A-4372, A-4374, A-4376, A-4377, A-4378, A-4379, A-4380, A-4383, A-4385, A-4386, A-4387, A-4394, A-4395, A-4397, A-4400, A-4401, A-4403, A-4411, A-4417, A-4418, A-4428.</p> <p style="text-align: center;">NOTE</p> <p style="text-align: center;">Spiral bevel gears with the suffix R after the serial number are acceptable for service.</p> <p>Transmissions/helicopters delivered with an affected serial numbered spiral bevel gear 204-040-701-103</p> <p>Bevel Gear: A-3843, A-3863, A-3870, A-3876, A-3898, A-3900, A-4026, A-4037, A-4229, A-4231</p> <p>Transmission: A-114, A-122, A-124, A-125, A-127, A-128, A-129, A-132, A-133, A-140</p> <p>Model 412: 33175, 33177, 33178, 33179, 33181, 33182, 33185, 33186, SPARE, 33192</p>		

SPECIAL INSPECTIONS

5-17. DAILY/10 HOUR INSPECTION, WHICHEVER OCCURS FIRST UNTIL 250 HOURS (CONT)

DATA REFERENCE	INSPECTION TASK DESCRIPTION	INITIAL	
		MECH	OTHER
Chapter 63 BHT-412-CR&O	<p>1. Remove and inspect transmission internal sump filter for metal contamination. If metal contamination is evident, notify Product Support Engineering of spiral bevel gear serial number, hours, and type contamination.</p> <p>2. Every 50 hours (until 250 hours), visually inspect spiral bevel gear.</p> <p style="padding-left: 40px;">a. Remove quill pad cover (204-040-174-001) or rotor brake quill (if installed) from transmission.</p> <p style="padding-left: 40px;">b. Utilizing the port opening in the main gear case and a bright light and mirror, inspect all 62 teeth in spiral bevel gear 204-040-701-103. Carefully inspect each tooth for evidence of chipping or loss of material (Figure 5-11).</p> <p style="padding-left: 40px;">c. Remove and replace any gear not meeting inspection requirements set forth in step b. Notify Product Support Engineering of serial number and total time of any gear replaced.</p> <p style="padding-left: 40px;">d. Install quill pad cover (or rotor brake quill).</p> <p>3. Return spare (uninstalled) affected serial numbered spiral bevel gears to Bell Helicopter Textron for inspection and re-identification.</p>		

SPECIAL INSPECTIONS

5-18. BETWEEN 1 AND 5 FLIGHT HOURS AFTER MAIN ROTOR HUB INSTALLATION

DATA REFERENCE	INSPECTION TASK DESCRIPTION	INITIAL MECH OTHER	
Chapter 62	<p>DATE: _____ W.O. _____</p> <p>FACILITY: _____</p> <p>HELICOPTER S/N: _____</p> <p>REGISTRY NO.: _____</p> <p>TOTAL TIME: _____</p> <p>SIGNATURE: _____</p> <p style="text-align: center;">NOTE</p> <p style="text-align: center;">Accomplish between 1 and 5 hours of flight after installation of main rotor hub.</p> <p><u>MAIN ROTOR HUB</u></p> <p>1. Torque check eight main rotor hub/yoke through bolt nuts to 70 to 80 foot-pounds (95 to 108 Nm).</p> <div style="text-align: center;">  <p>CAUTION</p> </div> <p style="text-align: center;">SPECIAL TORQUE SEQUENCE REQUIRED FOR FOLLOWING STEPS.</p> <p>2. Torque check eight main rotor hub cap bolt assemblies to 250 to 260 inch-pounds (28.25 to 29.37 Nm).</p> <p>3. Torque check lower cone bolts to 125 to 135 inch-pounds (14.13 to 15.25 Nm).</p>		

SPECIAL INSPECTIONS

5-19. BETWEEN 1 AND 25 FLIGHT HOURS AFTER EXPANDABLE BLADE BOLT INSTALLATION

DATA REFERENCE	INSPECTION TASK DESCRIPTION	INITIAL MECH OTHER	
Chapter 62	<p>DATE: _____ W.O. _____</p> <p>FACILITY: _____</p> <p>HELICOPTER S/N: _____</p> <p>REGISTRY NO.: _____</p> <p>TOTAL TIME: _____</p> <p>SIGNATURE: _____</p> <p style="text-align: center;">NOTE</p> <p>Verify expandable blade bolt handle (1, Figure 5-7) force at initial installation and again in 1 to 25 flight hours after installation.</p> <p><u>EXPANDABLE BLADE BOLT (412-010-137-103)</u></p> <ol style="list-style-type: none"> 1. Remove safety lock pin from lower end of expandable blade bolt (1). 2. Raise bolt handle (2) to reduce the diameter of the bolt ring segments. 3. Push down on bolt handle (2). Verify that force required to push handle down is between 50 and 75 pounds (222 to 334 N). Refer to Chapter 62 for expandable blade bolt handle tension adjustment. 4. If adjustment is required, do an additional handle force check in 1 to 25 flight hours. In two consecutive inspections if the handle force of an individual bolt is more than the permitted limits 50 and 75 pounds (222 to 334 N) notify Product Support Engineering. 		



SPECIAL INSPECTIONS

5-20. BETWEEN 5 AND 10 HOURS OF FLIGHT AFTER EACH INSTALLATION

DATA REFERENCE	INSPECTION TASK DESCRIPTION	INITIAL	
		MECH	OTHER
	<p>DATE: _____ W.O. _____</p> <p>FACILITY: _____</p> <p>HELICOPTER S/N: _____</p> <p>REGISTRY NO.: _____</p> <p>TOTAL TIME: _____</p> <p>SIGNATURE: _____</p> <p style="text-align: center;">NOTE</p> <p style="text-align: center;">Accomplish between 5 and 10 hours of flight after each installation.</p>		
Chapter 64	<p><u>TAIL ROTOR HUB AND BLADE ASSEMBLY</u></p> <p>1. Torque check tail rotor hub retaining nut to 900 inch-pounds (101.68 Nm).</p> <p>2. Torque check tail rotor blade retaining nuts to 500 to 550 inch-pounds (57 to 62 Nm) when tail rotor blades 212-010-750 are installed, or to 540 to 640 inch-pounds (61 to 73 Nm) when tail rotor blades 412-016-100 are installed.</p>		
Chapter 65	<p><u>TAIL ROTOR GEARBOX</u></p> <p>Torque check tail rotor gearbox retaining nuts to 200 to 235 inch-pounds (22.60 to 26.55 Nm). Using a 0.005 inch (0.13 mm) or less feeler gauge, verify no gap exists between gearbox input quill shim and gearbox case shim.</p>		
Chapter 65	<p><u>INTERMEDIATE GEARBOX</u></p> <p>Torque check intermediate gearbox retaining bolts to 50 to 70 inch-pounds (5.65 to 7.90 Nm).</p>		

SPECIAL INSPECTIONS

5-21. EACH 25 HOURS FOR THE NEXT FOUR INSPECTIONS

DATA REFERENCE	INSPECTION TASK DESCRIPTION	INITIAL MECH OTHER	
<p>ASB 412-95-84 Revision C</p>	<p>DATE: _____ W.O. _____</p> <p>FACILITY: _____</p> <p>HELICOPTER S/N: _____</p> <p>REGISTRY NO.: _____</p> <p>TOTAL TIME: _____</p> <p>SIGNATURE: _____</p> <p style="text-align: center;">NOTE</p> <p>Accomplish visual inspection of witness marks (only applicable to hanger bearing 204-040-623-003) each 25 flight hours for the next four inspections after installation or initial inspection of hanger bearings.</p> <p><u>TAIL ROTOR HANGER BEARINGS WITNESS MARKS</u></p> <ol style="list-style-type: none"> 1. Perform helicopter run-up for 5 minutes. Shut down helicopter and inspect tail rotor hanger bearings for movement of the dust shields, identified by breakage of the witness marks. Remove any bearings from service that display dust shield movement. 2. Hanger bearings not displaying movement at the run-up may remain in service, but must be inspected for dust shield movement at each of the next four mandatory 25 hour inspections, or any time the bearing is inspected between any of the 25 hour inspections. Bearings that do not display grease shield movement after the fourth 25 hour inspection may remain in service with no further inspection required. Record accomplishment of inspection in the helicopter log book. 3. Remove any hanger bearing from service whose witness marks indicates that grease shield has moved. 		

SPECIAL INSPECTIONS

5-22. EACH 25 HOURS OF TAIL ROTOR OPERATION

DATA REFERENCE	INSPECTION TASK DESCRIPTION	INITIAL	
		MECH	OTHER
Chapter 64	<p>DATE: _____ W.O. _____</p> <p>FACILITY: _____</p> <p>HELICOPTER S/N: _____</p> <p>REGISTRY NO.: _____</p> <p>TOTAL TIME: _____</p> <p>SIGNATURE: _____</p> <p style="text-align: center;">NOTE</p> <p>Accomplish inspection each 25 hours of flight operation.</p> <p><u>TAIL ROTOR STATIC STOP (212-011-713)</u></p> <p>Tail rotor static stop 212-011-713 for straightness across the outboard surface. If yielding has occurred, replace the tail rotor yoke and static stop. If any doubt exists as to the serviceability of these components, contact Product Support Engineering.</p>		
Chapter 64 ASB 412-13-155	<p><u>TAIL ROTOR BLADE (212-010-750-ALL ONLY)</u></p> <p style="text-align: center;">NOTE</p> <p>Removal of the tail rotor blades is not required for this inspection.</p> <ol style="list-style-type: none"> Clean each tail rotor blade by hand using mild soap and cheesecloth (C-486) in a spanwise direction; dry thoroughly. Carry out a detailed visual inspection of both sides of the entire blade with a 3X magnifying glass and a bright light. Inspect the tail rotor blade skin, leading edge spar, doublers, grip plates, and trailing edge for cracks, corrosion, nicks, dents, and scratches. Refer to Chapter 64 for damage limits. 		

SPECIAL INSPECTIONS

5-22. EACH 25 HOURS OF TAIL ROTOR OPERATION (CONT)

DATA REFERENCE	INSPECTION TASK DESCRIPTION	INITIAL	
		MECH	OTHER
	<p>3. Carry out a further detailed visual inspection, with a 10X magnifying glass, of the shaded area shown in Figure 5-5, between stations 20.00 and 35.00 of both sides of the blade, with a bright light.</p> <p>4. If any blistering, peeling, flaking, bubbling, or cracked paint is detected, remove the paint from the affected area by sanding in a spanwise direction only, with an abrasive cloth or paper (C-406) 240 grit or finer, and a final sanding with an abrasive cloth or paper (C-406) 400 grit or finer. After paint removal, visually inspect the affected area for damage with a 10X magnifying glass. Damage beyond the limits in Chapter 64 requires the blade be removed from service.</p> <p>5. Only superficial corrosion that can be removed with aluminum wool or very fine grade abrasive pad (C-407) is permissible. Corrosion on the spar 0.003 inch (0.08 mm) deep or less is acceptable when polished out. Replace any blade that has corrosion on the spar greater than 0.003 inch (0.08 mm).</p> <p>6. If a nick, scratch, or dent is found, visually inspect for crack using a 10X magnifying glass, or higher, and measure the depth of the damage. (A digital optical micrometer is one tool that can be used for this measurement.)</p> <p>7. Repair damage and/or corrosion found on tail rotor blades in accordance with Chapter 64.</p> <p>8. Replace any blade that has a crack. No cracks are permitted.</p> <p>9. If paint was removed during the previous steps, carry out paint touch-up/refinishing.</p>		

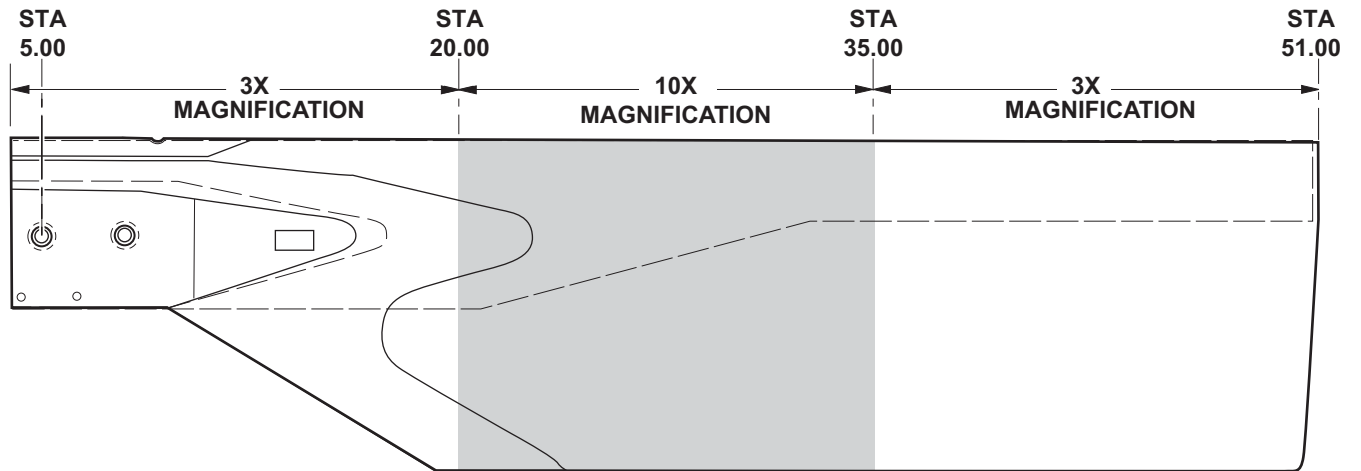

Figure 5-5. Tail Rotor Blade — Special Inspection

412_MM_05_0003

SPECIAL INSPECTIONS

5-23. 50 HOURS AFTER INSTALLATION OF COMPONENTS

DATA REFERENCE	INSPECTION TASK DESCRIPTION	INITIAL MECH OTHER	
<p>Chapter 53</p> <p>Chapter 63</p>	<p>DATE: _____ W.O. _____</p> <p>FACILITY: _____</p> <p>HELICOPTER S/N: _____</p> <p>REGISTRY NO.: _____</p> <p>TOTAL TIME: _____</p> <p>SIGNATURE: _____</p> <p style="text-align: center;">NOTE</p> <p style="text-align: center;">Accomplish 50 flight hours after each installation of components.</p> <p><u>TAILBOOM</u></p> <p>Torque check anti-torque bellcrank support (212-001-706-001, -101) attachment nuts to 75 to 95 inch-pounds (8.47 to 10.73 Nm).</p> <p><u>ROTOR BRAKE</u></p> <p>1. Torque check brake assembly (caliper) attachment bolts to 80 to 100 inch-pounds (9.04 to 11.29 Nm).</p> <p>2. Torque check brake disc attachment bolts to 50 to 70 inch-pounds (5.65 to 7.90 Nm).</p>		



SPECIAL INSPECTIONS

5-24. 100 HOURS AFTER INSTALLATION OF TAILBOOM

DATA REFERENCE	INSPECTION TASK DESCRIPTION	INITIAL	
		MECH	OTHER
Chapter 53	<p>DATE: _____ W.O. _____</p> <p>FACILITY: _____</p> <p>HELICOPTER S/N: _____</p> <p>REGISTRY NO.: _____</p> <p>TOTAL TIME: _____</p> <p>SIGNATURE: _____</p> <p style="text-align: center;">NOTE</p> <p>Accomplish 100 hours after each installation of tailboom.</p> <p><u>TAILBOOM</u></p> <p>Do a torque check of the tailboom attachment bolts.</p>		



SPECIAL INSPECTIONS

5-24A. EACH 100 HOURS TAILBOOM ATTACHMENT INSPECTION

DATA REFERENCE	INSPECTION TASK DESCRIPTION	INITIAL	
		MECH	OTHER
Chapter 4 ASB 412-00-100	DATE: _____ W.O. _____ FACILITY: _____ HELICOPTER S/N: _____ REGISTRY NO.: _____ TOTAL TIME: _____ SIGNATURE: _____ <p style="text-align: center;">NOTE</p> <p style="text-align: center;">Accomplish every 100 hours of helicopter operation.</p> <p style="text-align: center;">This inspection is mandated by Chapter 4 (Airworthiness Limitations Schedule), no extensions are permitted.</p> <p><u>FUSELAGE/TAILBOOM ATTACHMENT</u></p> <p>1. Inspect fuselage and tailboom attachment components and hardware for cracks with 10X magnifying glass. Pay particular attention to interface between forward end of tailboom attachment fitting and cap angle, and main beam web area below cap angle (Figure 5-10).</p>		



SPECIAL INSPECTIONS

5-24B. EACH 100 HOURS TAILBOOM VERTICAL FIN SPAR CAP INSPECTION

DATA REFERENCE	INSPECTION TASK DESCRIPTION	INITIAL MECH OTHER	
	<p>DATE: _____ W.O. _____</p> <p>FACILITY: _____</p> <p>HELICOPTER S/N: _____</p> <p>REGISTRY NO.: _____</p> <p>TOTAL TIME: _____</p> <p>SIGNATURE: _____</p> <p style="text-align: center;">NOTE</p> <p>Accomplish every 100 hours of helicopter operation. Applicable to tailboom vertical left hand fin spar cap 212-030-447-117.</p> <p><u>TAILBOOM VERTICAL LEFT HAND FIN SPAR CAP</u> <u>212-030-447-117</u></p> <ol style="list-style-type: none"> 1. Gain access to the spar cap angle by removing the 42-degree gearbox cover and opening the vertical fin driveshaft cover. 2. Clean exposed surfaces of spar cap to facilitate inspection. 3. Inspect both flanges of the left hand spar cap, between F.S. 50 and F.S. 71 using a 10x magnifying glass and a bright light, for cracks, loose rivets and other damage (Figure 5-5A). 4. Inspect the exterior of the fin skin in the area in contact with the spar cap for cracks, loose rivets and/or distortion. 5. If no cracks or other damage is found, close the driveshaft cover and reinstall the 42-degree gearbox cover. 6. If a crack or other damage is found, contact Product Support Engineering before further flight: <p style="text-align: center;">Bell Product Support Engineering Tel: 1-450-437-2862 / 1-800-363-8023 / productsupport@bellflight.com</p>		

Chapter 53
ASB 412-20-180

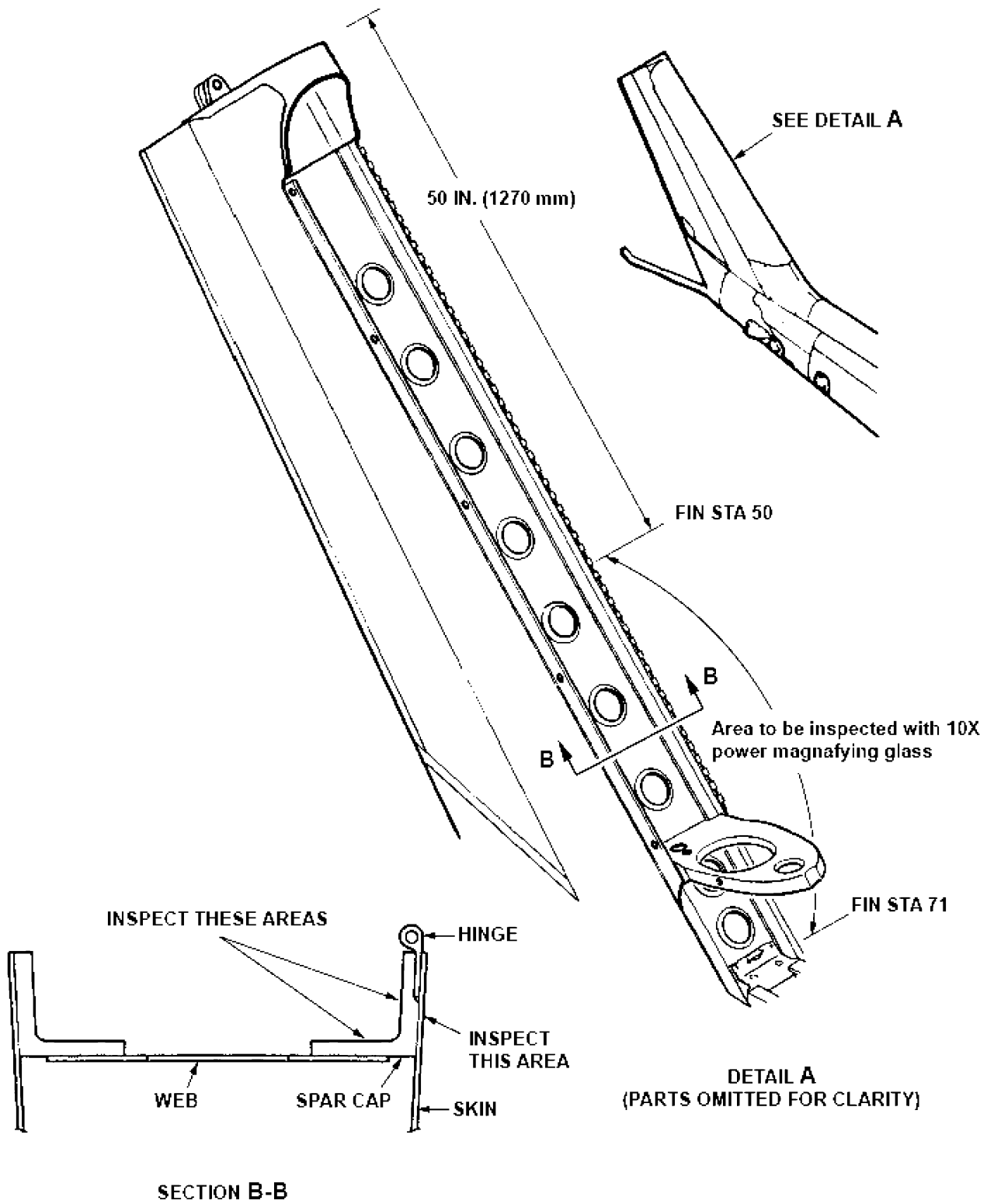

412_MM_05_006

Figure 5-5A. Vertical Fin Spar Cap – Special Inspection

SPECIAL INSPECTIONS

5-25. EACH 100 HOURS OF COLLECTIVE LEVER OPERATION

DATA REFERENCE	INSPECTION TASK DESCRIPTION	INITIAL	
		MECH	OTHER
ASB 412-11-148	<p>DATE: _____ W.O. _____</p> <p>FACILITY: _____</p> <p>HELICOPTER S/N: _____</p> <p>REGISTRY NO.: _____</p> <p>TOTAL TIME: _____</p> <p>SIGNATURE: _____</p> <p style="text-align: center;">NOTE</p> <p>Accomplish each 100 hours of collective lever 412-010-408-101 and -105 operation.</p> <p><u>COLLECTIVE LEVER 412-010-408-101/-105</u></p> <ol style="list-style-type: none"> 1. Prepare helicopter for maintenance. <ol style="list-style-type: none"> a. Gain access to the collective lever. 2. Use cleaning compound (C-318) or equivalent to thoroughly clean the collective lever in preparation for inspection. 3. Use a strong light source and a 10X magnifying glass to inspect the collective lever in the area shown in Figure 5-6. Due to difficult access, it is acceptable to inspect the lower side of the affected area with a strong light source and a mirror only. 4. Look for evidence of cracks in the paint. 5. If a crack is suspected, remove the collective lever from the swashplate assembly (Chapter 62). <ol style="list-style-type: none"> a. Perform a fluorescent penetrant inspection with local paint and primer removed in the suspected area (BHT-ALL-SPM, Chapter 6) 		

SPECIAL INSPECTIONS

5-25. EACH 100 HOURS OF COLLECTIVE LEVER OPERATION (CONT)

DATA REFERENCE	INSPECTION TASK DESCRIPTION	INITIAL	
		MECH	OTHER
	<p>6. If a crack is found, replace the collective lever with a serviceable part and contact Product Support Engineering to report the defect.</p> <p>7. If no cracks are found, refinish as required per the BHT-412-CR&O Manual.</p>		

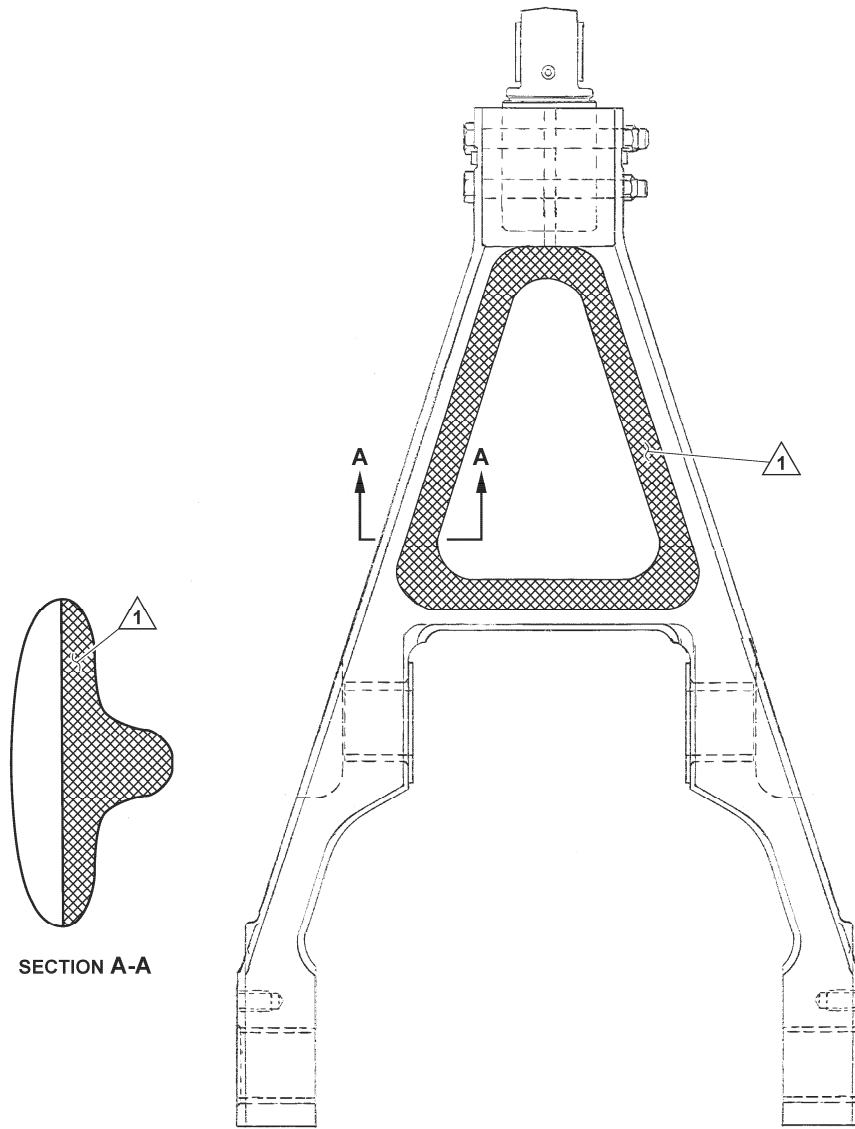

NOTE

 Area to be inspected with a 10X power magnifying glass. Due to difficult access, it is acceptable to inspect the lower side of the affected area with a strong light source and a mirror only.

11539_001

Figure 5-6. Collective Lever — Special Inspection

SPECIAL INSPECTIONS

5-26. EACH 150 HOURS OF STARTER GENERATOR (200SG119Q) OPERATION

DATA REFERENCE	INSPECTION TASK DESCRIPTION	INITIAL	
		MECH	OTHER
Chapter 71 TM106 – Aircraft Parts Corp. Overhaul Instructions with Illustrated Parts Breakdown	<p>DATE: _____ W.O. _____</p> <p>FACILITY: _____</p> <p>HELICOPTER S/N: _____</p> <p>REGISTRY NO.: _____</p> <p>TOTAL TIME: _____</p> <p>SIGNATURE: _____</p> <p style="text-align: center;">NOTE</p> <p>Accomplish each 150 hours of starter generator 200SG119Q operation or more frequently if conditions warrant.</p> <p>Part number 200SG119Q refers to the starter generator without the QAD kit consisting of the mounting flange and ring clamp.</p> <p>This special inspection is not applicable to starter generator 209-060-221-001.</p> <ol style="list-style-type: none"> 1. Remove starter generator 200SG119Q. 2. Inspect starter generator brushes for wear. 3. If brushes are worn beyond allowable limits, refer to vendor manual and replace in accordance with manufacturer's instructions. 4. Install starter generator. 		

SPECIAL INSPECTIONS

5-27. EACH 300 HOURS OR 6 MONTHS OF EXPANDABLE BLADE BOLT OPERATION

DATA REFERENCE	INSPECTION TASK DESCRIPTION	INITIAL	
		MECH	OTHER
ASB 412-09-137	<p>DATE: _____ W.O. _____</p> <p>FACILITY: _____</p> <p>HELICOPTER S/N: _____</p> <p>REGISTRY NO.: _____</p> <p>TOTAL TIME: _____</p> <p>SIGNATURE: _____</p> <p style="text-align: center;">NOTE</p> <p style="text-align: center;">Accomplish each 300 hours or 6 months of main rotor expandable blade bolt operation.</p> <p><u>EXPANDABLE BLADE BOLT (412-010-137-103)</u></p> <div style="text-align: center;">  <p>CAUTION</p> </div> <p>EXPANDABLE BOLT HANDLE SHALL NOT BE CLOSED WHEN THE BOLT IS NOT INSTALLED UNLESS THE TENSIONING NUT HAS BEEN LOOSENED. FAILURE TO FOLLOW THIS CAUTION COULD RESULT IN DAMAGING THE BOLT RING SEGMENTS.</p>		
Chapter 62	<p>1. Remove the main rotor expandable blade bolts (if installed) from the main rotor hub assembly.</p>		

SPECIAL INSPECTIONS

5-27. EACH 300 HOURS OR 6 MONTHS OF EXPANDABLE BLADE BOLT OPERATION (CONT)

DATA REFERENCE	INSPECTION TASK DESCRIPTION	INITIAL MECH OTHER	
BHT-412-CR&O	<div style="text-align: center; border: 2px dashed black; padding: 5px; width: fit-content; margin: 0 auto;"> <p>CAUTION</p> </div> <p>PAY PARTICULAR ATTENTION NOT TO DISTURB THE RING SEGMENT ORDER AND ORIENTATION DURING THE DISASSEMBLY AND ASSEMBLY OF THE EXPANDABLE BOLT.</p> <ol style="list-style-type: none"> 2. Clean the expandable blade bolt (1, Figure 5-7) with a clean cloth moistened with aliphatic naphtha (C-305) or isopropyl alcohol (C-385) and wipe dry with a clean rag. 3. Make sure the nut (4) is facing up before you disassemble the expandable blade bolt (1). 4. Remove the nut (4) from the core pin (5) with the expandable blade bolt handle (2) in the open (as removed) position. <p style="text-align: center;">NOTE</p> <p>For the blade bolt segment removal/installation workaid fabrication instructions, refer to the BHT-412-CR&O, Chapter 62.</p> <ol style="list-style-type: none"> 5. Attach the blade bolt segment removal/installation workaid to the threaded end of the core pin (5) until firmly seated (finger tight only). 6. Hold or secure the bolt handle (2) and, while holding the segments (3), invert the expandable bolt assembly to allow the segments to slide freely from the core pin (5) to the blade bolt segment removal/installation workaid. 7. With aliphatic naphtha (C-305) or isopropyl alcohol (C-385), clean the segments (3) and the core pin (5) without removing them from the blade bolt segment removal/installation workaid. Separate the segments to remove all dirt and debris. 8. Thoroughly dry the segments (3) and the core pin (5) with clean compressed air. 		

SPECIAL INSPECTIONS

5-27. EACH 300 HOURS OR 6 MONTHS OF EXPANDABLE BLADE BOLT OPERATION (CONT)

DATA REFERENCE	INSPECTION TASK DESCRIPTION	INITIAL	
		MECH	OTHER
Chapter 62	<p>9. Visually inspect the segments (3) and the expandable blade bolt (1) for cracks, fretting, corrosion, or mechanical damage. Refer to the BHT-412-CR&O, Chapter 62 for damage limits.</p> <p style="text-align: center;">NOTE</p> <p>Any bolts with damage beyond the limits of the BHT-412-CR&O, Chapter 62 must be removed from service.</p> <p>Repairable damage of the expandable blade bolt is limited to blending/polishing with 240-grit abrasive cloth or paper (C-423) followed by 320 and 400-grit abrasive cloth or paper (C-423).</p> <p>Apply solid film lubricant (C-021) to repaired areas and areas of burnished or missing solid film lubricant.</p> <p>10. Apply a thin continuous layer of grease (C-561) to the core pin (5) and the segments (3) both internally and externally on all surfaces.</p> <p>11. To begin reassembly, hold the end of the blade bolt segment removal/installation workaid and bolt handle (2). Invert the expandable blade bolt assembly to allow segments (3) to slide freely from the blade bolt segment removal/installation workaid back onto the core pin (5). Make sure the segments seat correctly against each other.</p> <p>12. Remove the blade bolt segment removal/installation workaid and install the nut (4) on the core pin (5).</p> <p>13. Install the main rotor expandable blade bolts (1) in the main rotor hub assembly.</p>		

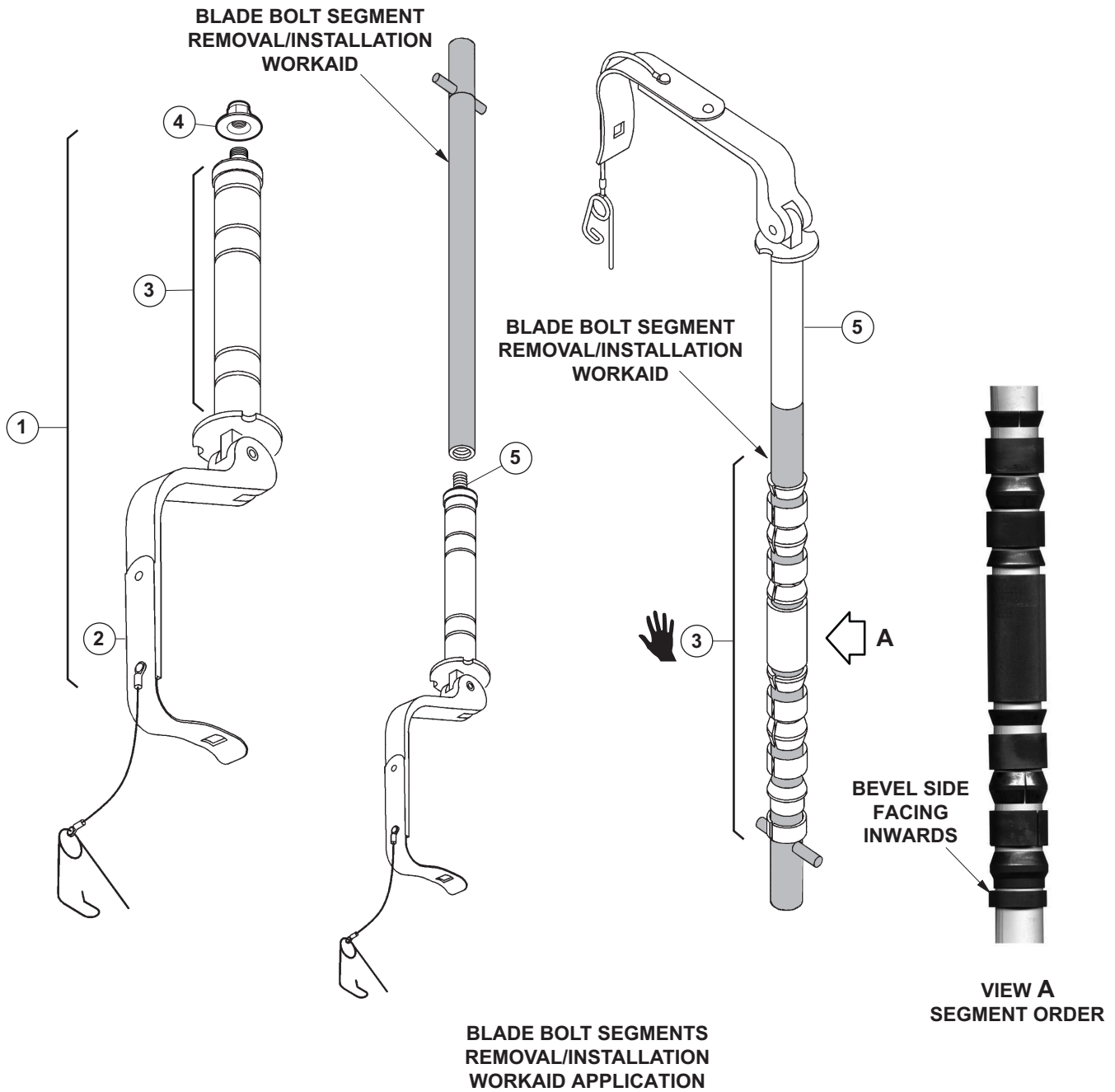

- 1. Expandable blade bolt
- 2. Bolt handle
- 3. Segments
- 4. Nut
- 5. Core pin



GREASE (C-561)

412_MM_05_0005

Figure 5-7. Expandable Blade Bolt — Special Inspection

SPECIAL INSPECTIONS

5-28. EACH 600 HOURS OF TAIL ROTOR DRIVESHAFT OPERATION OR 12 MONTHS

DATA REFERENCE	INSPECTION TASK DESCRIPTION	INITIAL	
		MECH	OTHER
Chapter 65	<p>DATE: _____ W.O. _____</p> <p>FACILITY: _____</p> <p>HELICOPTER S/N: _____</p> <p>REGISTRY NO.: _____</p> <p>TOTAL TIME: _____</p> <p>SIGNATURE: _____</p> <p style="text-align: center;">NOTE</p> <p>Accomplish each 600 hours of tail rotor driveshaft operation or 12 months, whichever occurs first (no Non Destructive Inspection (NDI) required).</p> <p><u>TAIL ROTOR DRIVESHAFT FLEXIBLE COUPLINGS</u></p> <p style="text-align: center;">NOTE</p> <p>Applicable to S/N 33001 through 33213 and 36001 through 36019 not modified by 412-570-001-103 or Pre BHT-412-SI-74 (412SP to 412HP Upgrade).</p> <p>1. Remove tail rotor driveshaft assemblies.</p> <p>2. Remove four tail rotor hanger assemblies 212-040-600-ALL.</p> <p style="text-align: center;">NOTE</p> <p>Disassemble flexible couplings only to the extent necessary to remove old grease and repack.</p>		
	BHT-412-CR&O, Chapter 65	<p>3. Clean, visually inspect, and repack tail rotor hanger assembly flexible couplings.</p> <p>4. Install four tail rotor hanger assemblies 212-040-600-ALL.</p>	

SPECIAL INSPECTIONS

5-28. EACH 600 HOURS OF TAIL ROTOR DRIVESHAFT OPERATION OR 12 MONTHS (CONT)

DATA REFERENCE	INSPECTION TASK DESCRIPTION	INITIAL	
		MECH	OTHER
Chapter 65	<p>5. Clean, visually inspect, and repack intermediate gearbox flexible couplings.</p> <p>6. Clean, visually inspect, and repack tail rotor gearbox flexible coupling.</p> <p>7. Clean, visually inspect, and repack transmission tail rotor driveshaft flexible coupling.</p> <p>8. Install tail rotor hanger assemblies.</p> <p>9. Install tail rotor driveshaft assemblies.</p> <p><u>TAIL ROTOR DRIVESHAFT FLEXIBLE COUPLINGS</u></p> <p style="text-align: center;">NOTE</p> <p style="text-align: center;">Applicable to S/N 36020 through 36999, S/N 37002 through 37999, S/N 38001 through 38999, S/N 39101 through 39999, and helicopters modified by 412-570-001-103 or Post BHT-412-SI-74 (412SP to 412HP Upgrade).</p>		
Chapter 65 BHT-412-CR&O	<p>1. Remove tail rotor coupling assembly 412-040-601-101 from transmission.</p> <p>2. Remove tail rotor coupling assembly 412-040-601-105/-107 from hanger support assembly.</p> <p style="text-align: center;">NOTE</p> <p style="text-align: center;">Disassemble flexible couplings only to the extent necessary to remove old grease and repack.</p> <p>3. Clean, visually inspect, and repack removed tail rotor coupling assemblies.</p> <p>4. Install tail rotor coupling assembly 412-040-601-101 on transmission.</p> <p>5. Install tail rotor coupling assembly 412-040-601-105/-107 on hanger support assembly.</p>		

SPECIAL INSPECTIONS

5-28. EACH 600 HOURS OF TAIL ROTOR DRIVESHAFT OPERATION OR 12 MONTHS (CONT)

DATA REFERENCE	INSPECTION TASK DESCRIPTION	INITIAL	
		MECH	OTHER
	<p>6. Remove tail rotor driveshaft assembly between intermediate gearbox and tail rotor gearbox.</p> <p style="text-align: center;">NOTE</p> <p style="text-align: center;">Disassemble flexible coupling only to the extent necessary to remove old grease and repack.</p> <p>7. Clean, visually inspect, and repack intermediate gearbox flexible coupling.</p> <p>8. Install tail rotor driveshaft assembly.</p>		

SPECIAL INSPECTIONS

5-29. EACH 600 HOURS OF MAIN DRIVESHAFT OPERATION OR 12 MONTHS

DATA REFERENCE	INSPECTION TASK DESCRIPTION	INITIAL	
		MECH	OTHER
Chapter 63 BHT-412-CR&O	<p>DATE: _____ W.O. _____</p> <p>FACILITY: _____</p> <p>HELICOPTER S/N: _____</p> <p>REGISTRY NO.: _____</p> <p>TOTAL TIME: _____</p> <p>SIGNATURE: _____</p> <p style="text-align: center;">NOTE</p> <p>Accomplish each 600 hours of main driveshaft operation or 12 months, whichever occurs first (no Non Destructive Inspection (NDI) required).</p> <p><u>MAIN DRIVESHAFT 212-040-005-003/-007/-103, AND 412-040-005-101/-103</u></p> <p>1. Remove main driveshaft.</p>		
	<p style="text-align: center;">NOTE</p> <p>Only disassemble driveshaft to the extent necessary to remove old grease and repack.</p> <p>2. Clean, visually inspect, and repack flexible couplings.</p> <p>3. Install main driveshaft.</p>		

SPECIAL INSPECTIONS

5-29. EACH 600 HOURS OF MAIN DRIVESHAFT OPERATION OR 12 MONTHS (CONT)

DATA REFERENCE	INSPECTION TASK DESCRIPTION	INITIAL	
		MECH	OTHER
Chapter 18	<p style="text-align: center;">NOTE</p> <p>Balancing of main driveshaft is required on helicopters S/N 36020 through 36999, S/N 37002 through 37999, S/N 38001 through 38999, S/N 39101 through 39999, and helicopters modified by 412-570-001-103 or Post BHT-412-SI-74 (412SP to 412HP Upgrade) anytime driveshaft is removed and reinstalled. Prior serial number helicopters, balancing of driveshaft is optional.</p> <p>4. Balance driveshaft to below 0.2 IPS.</p>		



SPECIAL INSPECTIONS

5-29A. EACH 600 HOURS OR 12 MONTHS INSPECTION OF MAGNETIC BRAKE ASSEMBLY

DATA REFERENCE	INSPECTION TASK DESCRIPTION	INITIAL MECH OTHER	
ASB 412-17-173	<p>DATE: _____ W.O. _____</p> <p>FACILITY: _____</p> <p>HELICOPTER S/N: _____</p> <p>REGISTRY NO.: _____</p> <p>TOTAL TIME: _____</p> <p>SIGNATURE: _____</p> <p style="text-align: center;">NOTE</p> <p>Accomplish the following inspection each 600 hours or 12 months, whichever occurs first.</p> <p>The following inspection is not applicable for the helicopter serial numbers 36026, 36052 and 36053 equipped with EFIS and 4-Axis AFCS Kits, 36087 through 36999 equipped with EFIS and 4-Axis AFCS kits (412-705-009, 412-705-051 and 412-705-024) and 37002 and subsequent equipped with 4-Axis AFCS kit (412-705-042).</p> <p><u>MAGNETIC BRAKE ASSEMBLY 204-001-376-003</u></p> <ol style="list-style-type: none"> 1. Perform a detailed visual inspection of the magnetic brake assembly in accordance with ASB 412-17-173. 2. If the mechanical damage exceeds the limitation, contact Product Support Engineering. 		

SPECIAL INSPECTIONS

5-30. EACH 1000 HOURS OF COMPONENT OPERATION

DATA REFERENCE	INSPECTION TASK DESCRIPTION	INITIAL	
		MECH	OTHER
Chapter 29 TB 412-17-240	<p>DATE: _____ W.O. _____</p> <p>FACILITY: _____</p> <p>HELICOPTER S/N: _____</p> <p>REGISTRY NO.: _____</p> <p>TOTAL TIME: _____</p> <p>SIGNATURE: _____</p> <p style="text-align: center;">NOTE</p> <p>Accomplish each 1000 hours of component operation.</p> <p><u>HYDRAULIC ACCUMULATORS</u></p> <p style="text-align: center;">NOTE</p> <p>The following inspection is not required if the intent of the TB 412-17-240 is accomplished.</p> <p style="text-align: center;">NOTE</p> <p>The following procedure only applies to helicopters S/N 33001 through 33213 and 36001 through 36627.</p>		
	BHT-412-CR&O		
Chapter 29	<ol style="list-style-type: none"> 5. Install hydraulic accumulators. 		

SPECIAL INSPECTIONS

5-30. EACH 1000 HOURS OF COMPONENT OPERATION (CONT)

DATA REFERENCE	INSPECTION TASK DESCRIPTION	INITIAL	
		MECH	OTHER
Chapter 79	<u>OIL COOLER BLOWERS</u>		
BHT-412-CR&O	<ol style="list-style-type: none"> 1. Remove oil cooler blowers. 2. Disassemble, clean, and visually inspect for corrosion and damage. 3. Replace bearings and any other unserviceable parts. 4. Reassemble oil cooler blowers. 5. Install oil cooler blowers. 		

SPECIAL INSPECTIONS

5-31. EACH 12 MONTHS OR 2500 LANDINGS OF AFT HIGH CROSSTUBE OPERATION

DATA REFERENCE	INSPECTION TASK DESCRIPTION	INITIAL MECH OTHER	
<p>Chapter 32 ASB 412-09-135</p>	<p>DATE: _____ W.O. _____</p> <p>FACILITY: _____</p> <p>HELICOPTER S/N: _____</p> <p>REGISTRY NO.: _____</p> <p>TOTAL TIME: _____</p> <p>SIGNATURE: _____</p> <p style="text-align: center;">NOTE</p> <p style="text-align: center;">Accomplish each 12 Months or 2500 landings, whichever occurs first.</p> <p style="text-align: center;"><u>HIGH AFT CROSSTUBE ASSEMBLIES (412-050-011-ALL AND 412-050-045-ALL) DEFLECTION CHECK</u></p> <p>1. Hoist or jack the helicopter until the weight is removed from the landing gear assembly.</p> <div style="text-align: center;">  <p>CAUTION</p> </div> <p style="text-align: center;">ENSURE HELICOPTER IS STABILIZED ON JACKS BEFORE PROCEEDING TO ACQUIRING MEASUREMENTS.</p>		
<p>Chapter 32</p>	<p>2. Confirm aft crosstube is within deflections limits in accordance with Chapter 32.</p> <p>3. Replace aft crosstubes that exceed the required dimensional tolerances.</p>		

SPECIAL INSPECTIONS

5-31. EACH 12 MONTHS OR 2500 LANDINGS OF AFT HIGH CROSSTUBE OPERATION (CONT)

DATA REFERENCE	INSPECTION TASK DESCRIPTION	INITIAL	
		MECH	OTHER
<p>BHT-ALL-SPM</p> <p>Chapter 32 ASB 412-09-135</p>	<p><u>HIGH AFT CROSSTUBE ASSEMBLIES (412-050-011-ALL AND 412-050-045-ALL) FLUORESCENT PENETRANT INSPECTION</u></p> <p style="text-align: center;">NOTE</p> <p>The Fluorescent Penetrant Inspection shall be accomplished by persons meeting the personnel qualification and certification requirements of BHT-ALL-SPM (Chapter 6). Bell Helicopter trained Level 1 Special individuals are qualified to perform this inspection.</p> <ol style="list-style-type: none"> 1. Remove the landing gear assembly. 2. Remove the aft crosstube from the landing gear assembly. 3. Remove the support beam assembly from the high aft crosstube assembly. 4. Remove the hardware retaining the left and right clamp assemblies (1, Figure 5-8) on the crosstube. <div style="text-align: center;">  <p>CAUTION</p> </div> <p>CROSSTUBE TEMPERATURE NOT TO EXCEED 200°F (93.3°C). EXCESSIVE HEAT WILL DAMAGE CROSSTUBE.</p> <ol style="list-style-type: none"> 5. Use a heat gun to soften sealant bonding the clamp assembly (1) to the aft crosstube (3). 6. Separate the clamp assembly (1) from the aft crosstube (3) and abrasion strip (2). <p style="text-align: center;">NOTE</p> <p>Removal of the abrasion strips (2) from the aft crosstube (3) is not necessary to accomplish the Fluorescent Penetrant Inspection.</p>		



SPECIAL INSPECTIONS

5-31. EACH 12 MONTHS OR 2500 LANDINGS OF AFT HIGH CROSSTUBE OPERATION (CONT)

DATA REFERENCE	INSPECTION TASK DESCRIPTION	INITIAL	
		MECH	OTHER
Chapter 32	<p>7. Inspect the abrasion strips (2) for de-bonding. If de-bonding is found refer to Chapter 32 for repair instructions.</p> <p style="text-align: center;">NOTE</p> <p>Complete edge sealing is required to prevent contamination of the bond between the crosstube and upper and lower supports (4 and 6).</p> <p>8. Inspect the sealant bead around the periphery of the upper and lower supports (4 and 6) for condition. If the sealant bead has been damaged, investigate further.</p>		
Chapter 32	<p>9. Inspect crosstube lower support (6) and abrasion strip (5) for signs of looseness or debonding. If looseness or debonding is found, refer to Chapter 32 for repair instructions.</p> <p style="text-align: center;">NOTE</p> <p>The upper support (4) on the aft crosstube (3) is bonded with structural adhesive and is not designed to be removed.</p>		
Chapter 32	<p>10. Inspect the upper support (4) for signs of looseness or debonding. If looseness or debonding is found refer to Chapter 32 for repair instructions.</p> <div style="text-align: center;">  <p>CAUTION</p> </div> <p>PROTECT ABRASION STRIPS AND UPPER AND LOWER SUPPORTS FROM PAINT REMOVER CONTAMINATION.</p> <p>11. Prepare the aft crosstube for the inspection by removing the paint on the crosstube in the area indicated in Figure 5-8 with the exception of the abrasion strip areas and the upper and lower supports.</p>		
BHT-ALL-SPM	<p>12. Apply paint remover (C-436) to the crosstube with a brush following manufacturer's directions and the BHT-ALL-SPM.</p>		

SPECIAL INSPECTIONS

5-31. EACH 12 MONTHS OR 2500 LANDINGS OF AFT HIGH CROSSTUBE OPERATION (CONT)

DATA REFERENCE	INSPECTION TASK DESCRIPTION	INITIAL	
		MECH	OTHER
BHT-ALL-SPM	<div style="text-align: center;">  <p>CAUTION</p> </div> <p>A PLASTIC SCRAPER OR ABRASIVE PAD C-407 MAY BE USED TO GENTLY ASSIST PAINT REMOVAL. USE THE PLASTIC SCRAPER OR ABRASIVE PAD IN A LONGITUDINAL DIRECTION ONLY, ENSURING NOT TO ABRABE THE CROSSTUBE METAL SURFACE.</p> <p>13. Reapply paint remover as required to completely remove paint and primer.</p> <p>14. Using potable water rinse the crosstube surface until clean and dry thoroughly.</p> <p>15. Ensure the crosstube is free of paint and primer residue and bare metal is clearly visible in the required area.</p> <p>16. If the fluorescent penetrant inspection is not going to be accomplished immediately then protect the crosstube by applying corrosion preventive compound (C-125). Wrap exposed area in barrier material (C-427) and secure with tape (C-410).</p>		
BHT-ALL-SPM	<div style="text-align: center;">  <p>CAUTION</p> </div> <p>USE CARE TO PREVENT CONTAMINATION OF THE ABRASION STRIPS AND UPPER AND LOWER SUPPORTS FROM THE FLUORESCENT PENETRANT CHEMICALS.</p>		
	<p style="text-align: center;">NOTE</p> <p>The crosstube Fluorescent Penetrant Inspection can be accomplished by any person meeting the personnel Qualification/Certification Requirements of the BHT-ALL-SPM, Chapter 6. A Bell Helicopter trained Level 1 Special individual is qualified.</p>		

SPECIAL INSPECTIONS

5-31. EACH 12 MONTHS OR 2500 LANDINGS OF AFT HIGH CROSSTUBE OPERATION (CONT)

DATA REFERENCE	INSPECTION TASK DESCRIPTION	INITIAL	
		MECH	OTHER
BHT-ALL-SPM Chapter 32 Chapter 32 BHT-ALL-SPM	<p>17. Inspect the aft crosstube (3, Figure 5-8) with the exception of the areas under the abrasion strips (2 and 5) and upper support (4) as follows:</p> <p style="text-align: center;">NOTE</p> <p>All penetrant inspection materials utilized shall be compatible, and shall meet requirements of SAE AMS 2644. The use of visible dye systems is prohibited.</p> <p>a. Use fluorescent penetrant inspection method per ASTM E1417, Type 1 Method B, C, or D using a penetrant sensitivity level of 2 or 3 (BHT-ALL-SPM, Chapter 6).</p> <p>b. Inspect crosstube for damage per limits specified in the Chapter 32 to determine allowable damage and cleanup.</p> <p>c. No cracks are permitted.</p> <p>d. Repair all damage in accordance with Chapter 32.</p> <p>18. Apply epoxy primer coating (C-246) to areas where paint has been removed for inspection as per the BHT-ALL-SPM.</p> <div style="text-align: center;">  <p>CAUTION</p> </div> <p>DO NOT SAND CROSSTUBE IN A CIRCUMFERENTIAL DIRECTION. SAND CROSSTUBE IN A LONGITUDINAL DIRECTION ONLY.</p> <p>19. Taking care not to expose bare material, lightly abrade the primer on the crosstube and abrasion strip where the clamp assembly (1) is installed.</p>		

SPECIAL INSPECTIONS

5-31. EACH 12 MONTHS OR 2500 LANDINGS OF AFT HIGH CROSSTUBE OPERATION (CONT)

DATA REFERENCE	INSPECTION TASK DESCRIPTION	INITIAL	
		MECH	OTHER
	<div style="border: 2px dashed black; padding: 5px; width: fit-content; margin: 0 auto;"> <p>CAUTION</p> </div> <p>CONFIRM BAND CLAMP ASSEMBLY POSITIONING PRIOR TO INSTALLATION. DO NOT POSITION BAND CLAMP OVERLAP AT CENTER OF RETENTION CAP RUBBER BUMPER. OVER-ROTATION OF THE CLAMP ASSEMBLY COULD RESULT IN DAMAGE TO THE AIRFRAME FROM THE CLAMP "T" BOLTS.</p> <p>20. Remove protective backing film (to expose adhesive film) from clamp assembly (1).</p> <p>21. Install clamp assembly (1) using sealant (C-308) as per Chapter 32. Ensure complete sealant coverage of the inner clamp surface, avoiding air pockets.</p> <p>22. Torque clamp assembly (1) nuts 50 to 70 inch-pounds (5.6 to 7.9 Nm).</p> <p style="text-align: center;">NOTE</p> <p style="text-align: center;">The "T" bolt should have approximately 0.5 inch (13 mm) of threads visible after installation.</p> <p>23. If required, trim the "T" bolts on the clamp assembly (1) to provide adequate clearance with fuselage tunnel; deburr as required. Apply epoxy primer coating (C-246) and paint bare metal on "T" bolt for corrosion protection.</p> <p>24. Repaint crosstube (BHT-ALL-SPM, Chapter 4).</p> <p>25. Install the support beam assembly onto the aft crosstube.</p> <p>26. Install the aft crosstube onto the landing gear assembly.</p> <p>27. Install the landing gear assembly.</p>		
BHT-ALL-SPM and Chapter 32			
BHT-ALL-SPM			
BHT-ALL-SPM Chapter 32			

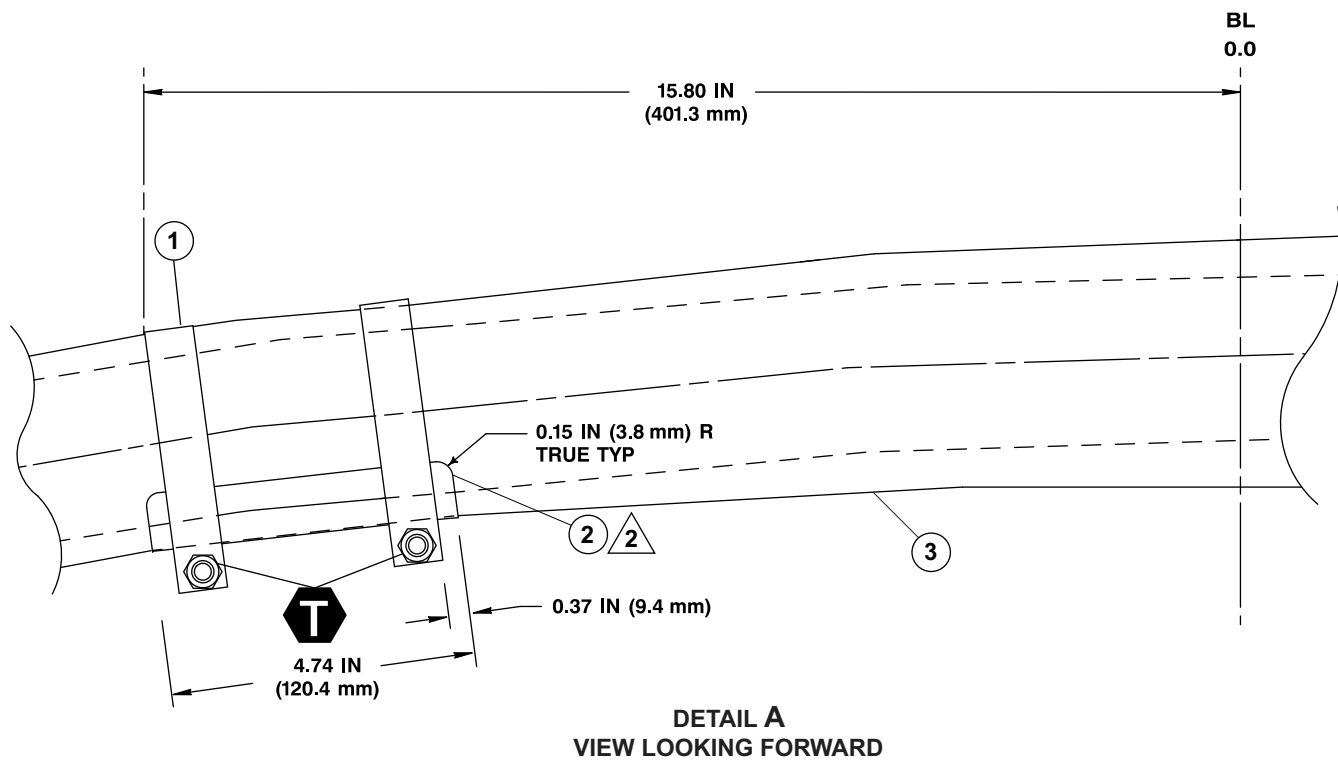
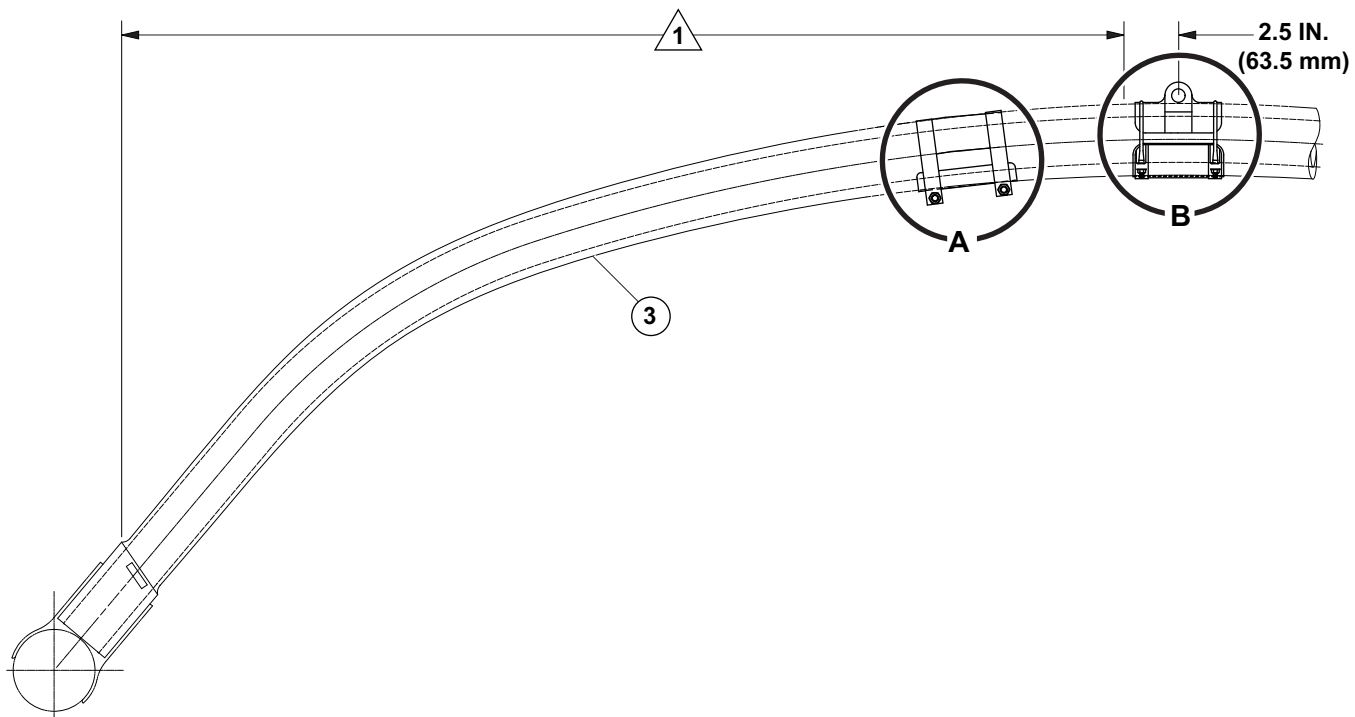
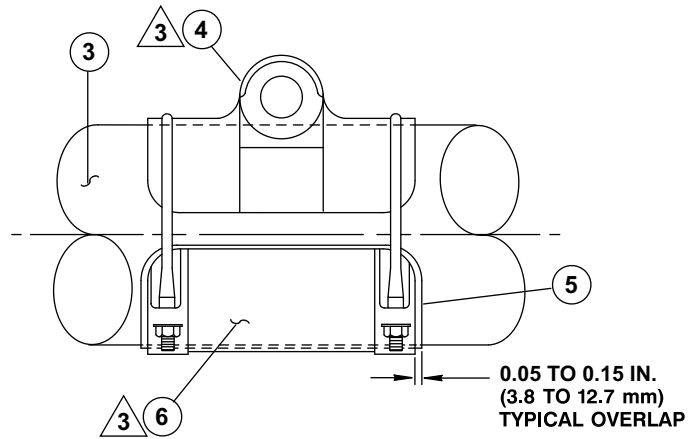

Figure 5-8. Aft High Crosstube — Special Inspection (Sheet 1 of 2)

412_MM_05_0002a



DETAIL B
VIEW LOOKING FORWARD

1. Clamp assembly
2. Abrasion strip
3. Aft crosstube
4. Upper support
5. Larson L101 abrasion strip
6. Lower support

T 50 TO 70 IN-LBS
(5.6 TO 7.9 Nm)

NOTES

- 1 Remove paint/primer from the aft crosstube (3) on the left and right-hand sides.
- 2 Protect abrasion strip (if installed) during paint removal process.
- 3 Protect upper and lower supports (4 and 6) during paint removal process.

412_MM_05_0002b

Figure 5-8. Aft High Crosstube — Special Inspection (Sheet 2 of 2)

SPECIAL INSPECTIONS

5-32. EACH 24 MONTHS OF CONTROL BOLT OPERATION

DATA REFERENCE	INSPECTION TASK DESCRIPTION	INITIAL											
		MECH	OTHER										
Chapter 29 Chapter 62 Chapter 63 Chapter 67	<p>DATE: _____ W.O. _____</p> <p>FACILITY: _____</p> <p>HELICOPTER S/N: _____</p> <p>REGISTRY NO.: _____</p> <p>TOTAL TIME: _____</p> <p>SIGNATURE: _____</p> <p style="text-align: center;">NOTE</p> <p>Accomplish each 24 months of control bolt operation.</p> <p style="text-align: center;"><u>FLIGHT CONTROL SYSTEM BOLTS</u></p> <p style="text-align: center;">NOTE</p> <p>Refer to Chapter 4 for retirement life of flight control bolts.</p> <p>1. Remove the following flight control bolts:</p> <table border="1" style="width: 100%; border-collapse: collapse;"> <thead> <tr> <th style="width: 50%;">BOLT PART NUMBER</th> <th style="width: 50%;">LOCATION</th> </tr> </thead> <tbody> <tr> <td>20-057-5-24D</td> <td>Swashplate inner ring to L/H and R/H cyclic boost (2)</td> </tr> <tr> <td>20-057-5-24D</td> <td>Collective lever to collective boost (1)</td> </tr> <tr> <td>20-057-5-24D</td> <td>Boost tube to universal (3)</td> </tr> <tr> <td>20-057-5-24D</td> <td>Universal to boost tube (3)</td> </tr> </tbody> </table>	BOLT PART NUMBER	LOCATION	20-057-5-24D	Swashplate inner ring to L/H and R/H cyclic boost (2)	20-057-5-24D	Collective lever to collective boost (1)	20-057-5-24D	Boost tube to universal (3)	20-057-5-24D	Universal to boost tube (3)		
	BOLT PART NUMBER	LOCATION											
20-057-5-24D	Swashplate inner ring to L/H and R/H cyclic boost (2)												
20-057-5-24D	Collective lever to collective boost (1)												
20-057-5-24D	Boost tube to universal (3)												
20-057-5-24D	Universal to boost tube (3)												

SPECIAL INSPECTIONS

5-32. EACH 24 MONTHS OF CONTROL BOLT OPERATION (CONT)

DATA REFERENCE	INSPECTION TASK DESCRIPTION	INITIAL		
		MECH	OTHER	
BHT-ALL-SPM	20-057-5-28D	Pitch horn to pitch link (4) \triangle_2		
	20-057-6-36D (or 20-057-6-52D)	Pitch link to rephasing lever (4)		
	20-057-6-36D	Drive Link to rephasing lever (4) \triangle_1		
	20-057-6-36D (or 20-057-6-38D)	Swashplate link to rotating ring (2) \triangle_1		
	20-057-6-52D	Swashplate link to rephasing lever (2) \triangle_1		
	20-057-8-84D	Rephasing lever to hub (4)		
	20-057-8-92D	Collective lever to swashplate support (1)		
	212-001-323-001	Hydraulic cylinder to lower support (3)		
	<p>2. Clean bolts with cloth dampened with MEK (C-309) or equivalent.</p> <p>3. Inspect bolts for thread damage, shank wear, and corrosion. Replace any bolt that has damaged threads, detectable shank wear, or exhibits corrosion pitting.</p> <p>4. Apply corrosion preventive compound (C-104) to bolt shanks only and install. Do not apply to the bolt threads.</p> <p>5. Operations in extreme environmental conditions, that erode hard film corrosion preventive compound (C-101), may warrant periodic touch-up of control bolts external surfaces. Prior to touch-up, visually check exposed surfaces of hardware for evidence of corrosion and fretting. Remove, clean, and inspect bolts as conditions warrant.</p> <p>6. After bolts have been installed and nuts torqued and lockwired, coat bolt heads and nuts with corrosion preventive compound (C-101).</p>			

SPECIAL INSPECTIONS

5-32. EACH 24 MONTHS OF CONTROL BOLT OPERATION (CONT)

DATA REFERENCE	INSPECTION TASK DESCRIPTION	INITIAL	
		MECH	OTHER
TB 412-86-52	<p>NOTES:</p> <p><u>1</u> If dual drive links were not installed (S/N 33001 through 33107), the following quantities apply:</p> <ul style="list-style-type: none"> a. Drive link to rephasing lever (2) 20-057-36D b. Swashplate link to rephasing lever (3), 20-057-6-38D c. Swashplate link to rotating ring (3) 20-057-6-36D. <p><u>2</u> As per ASB 412-98-92, bolt 20-057-5-25D is replaced by 20-057-5-28D.</p>		



SPECIAL INSPECTIONS

5-33. EACH 24 MONTHS OF MAIN ROTOR MAST OPERATION

DATA REFERENCES	INSPECTION TASK DESCRIPTION	INITIAL	
		MECH	OTHER
<p>Chapter 62</p> <p>BHT-412-CR&O Chapter 63</p> <p>Chapter 62</p>	<p>DATE: _____ W.O. _____</p> <p>FACILITY: _____</p> <p>HELICOPTER S/N: _____</p> <p>REGISTRY NO.: _____</p> <p>TOTAL TIME: _____</p> <p>SIGNATURE: _____</p> <p style="text-align: center;">NOTE</p> <p>Accomplish every 24 months of main rotor mast operation when operating in a non-corrosive environment. If helicopter is operated in a corrosive environment, it is recommended this inspection be accomplished every 12 months.</p> <p><u>MAIN ROTOR MAST ASSEMBLY (412-040-366-SERIES AND 412-040-368-SERIES)</u></p> <ol style="list-style-type: none"> 1. Remove main rotor hub assembly. 2. Clean then visually inspect main rotor mast upper splines for corrosion. 3. Install main rotor hub assembly. 		

SPECIAL INSPECTIONS

5-34. EACH 2500 HOURS OF MAIN ROTOR HUB ASSEMBLY OPERATION

DATA REFERENCE	INSPECTION TASK DESCRIPTION	INITIAL	
		MECH	OTHER
Chapter 62 BHT-412-CR&O	<p>DATE: _____ W.O. _____</p> <p>FACILITY: _____</p> <p>HELICOPTER S/N: _____</p> <p>REGISTRY NO.: _____</p> <p>TOTAL TIME: _____</p> <p>SIGNATURE: _____</p> <p style="text-align: center;">NOTE</p> <p>Accomplish each 2500 hours of main rotor hub operation.</p> <p><u>MAIN ROTOR HUB ASSEMBLY (412-010-100-SERIES) AND 412-010-502-SERIES</u></p> <p>1. Disassemble main rotor hub. Visually inspect eight drive pins 412-010-166.</p> <p style="text-align: center;">NOTE</p> <p>Pitch horn to spindle attachment bolts do not need to be removed unless there is evidence of looseness or external corrosion on the bolt head.</p>		
TB 412-92-112	<p style="text-align: center;">NOTE</p> <p>Some yoke assemblies 412-010-101-123, -127 were delivered with oversized bushings.</p> <p>3. Visually inspect all elastomeric bearings for condition, deterioration, and separation.</p>		

SPECIAL INSPECTIONS

5-35. EACH 2500 HOURS OF MAIN ROTOR BLADE OPERATION

DATA REFERENCE	INSPECTION TASK DESCRIPTION	INITIAL MECH OTHER	
<p>Chapter 62</p> <p>BHT-412-CR&O</p>	<p>DATE: _____ W.O. _____</p> <p>FACILITY: _____</p> <p>HELICOPTER S/N: _____</p> <p>REGISTRY NO.: _____</p> <p>TOTAL TIME: _____</p> <p>SIGNATURE: _____</p> <p style="text-align: center;">NOTE</p> <p style="text-align: center;">Accomplish every 2500 hours of main rotor blade operation.</p> <p style="text-align: center;"><u>MAIN ROTOR BLADES (412-015-200/-300 SERIES)</u></p> <ol style="list-style-type: none"> 1. Remove each main rotor blade. 2. Inspect for condition in accordance with main rotor blade normal inspection criteria. 		



SPECIAL INSPECTIONS



5-36. EACH 2500 OR 3000 HOURS OR 5 YEARS OF MAIN ROTOR MAST (412-040-366-109 AND SUBSEQUENT) OPERATION

DATA REFERENCE	INSPECTION TASK DESCRIPTION	INITIAL	
		MECH	OTHER
	<p>DATE: _____ W.O. _____</p> <p>FACILITY: _____</p> <p>HELICOPTER S/N: _____</p> <p>REGISTRY NO.: _____</p> <p>TOTAL TIME: _____</p> <p>SIGNATURE: _____</p> <p style="text-align: center;">NOTE</p> <p>Accomplish each 2500 hours or 5 years of main rotor mast (412-040-366-109 and subsequent) operation on helicopters S/N 36020 through 36670 and helicopters modified by 412-570-001-103 or Post BHT-412-SI-74 (412SP to 412HP Upgrade).</p> <p style="text-align: center;">NOTE</p> <p>Accomplish each 3000 hours or 5 years of main rotor mast (412-040-366-109 and subsequent) operation if the intent of TB 412-14-231 has been complied with on helicopters S/N 36020 through 36670 and helicopters modified by 412-570-001-103 or Post BHT-412-SI-74 (412SP to 412HP Upgrade).</p> <p style="text-align: center;">NOTE</p> <p>Accomplish each 3000 hours or 5 years of main rotor mast (412-040-366-129 and subsequent) operation on helicopters S/N 36671 through 36999 and S/N 37002 through 37999.</p>		



SPECIAL INSPECTIONS

5-36. EACH 2500 OR 3000 HOURS OR 5 YEARS OF MAIN ROTOR MAST (412-040-366-109 AND SUBSEQUENT) OPERATION (CONT)

DATA REFERENCE	INSPECTION TASK DESCRIPTION	INITIAL MECH OTHER	
<p>Chapter 63 BHT-412-CR&O</p>	<p><u>MAIN ROTOR MAST (412-040-366-109, AND SUBSEQUENT)</u></p> <div style="text-align: center;">  <p>CAUTION</p> </div> <p>REMOVE MONOPOLE SENSOR BEFORE REMOVING MAST.</p> <p style="text-align: center;">NOTE</p> <p>Prior to removing mast assembly from transmission, check chip detector located in top case for evidence of debris. Presence of ferrous foreign material on chip detector will require additional inspection to determine origin.</p> <p>The 412-040-366-109 (Pre TB 412-01-179) mast is not field serviceable and must be returned to BHTI for the following inspections. The mast assembly must be returned with torquemeter tube, plug, and lower torquemeter rotor in place. Also note the number of the monopole sensor 412-375-004-105 or -107 used with the mast.</p> <ol style="list-style-type: none"> 1. Remove main rotor mast assembly from transmission. <div style="text-align: center;">  <p>CAUTION</p> </div> <p>DO NOT STAND OR LAY MAST HORIZONTALLY WITH MAST BEARING RETAINING PLATE SUPPORTING WEIGHT OF MAST.</p> <ol style="list-style-type: none"> 2. Place main rotor mast assembly in horizontal position on padded support, such as V blocks. 3. Remove lock ring, mast bearing retaining plate, and shim. 4. Visually inspect seal for signs of overheating, cracking, wear, or damage. 		



SPECIAL INSPECTIONS

5-36. EACH 2500 OR 3000 HOURS OR 5 YEARS OF MAIN ROTOR MAST (412-040-366-109 AND SUBSEQUENT) OPERATION (CONT)

DATA REFERENCE	INSPECTION TASK DESCRIPTION	INITIAL	
		MECH	OTHER
	<p>5. Check mast bearing for smooth rolling and freedom from binding.</p> <p>6. Visually examine lower mast bearing inner race for scratches, dents, corrosion, pitting, spalling, roller skidding, or scoring.</p> <p>7. Visually examine splines on mast for dents, wear, or damage.</p> <div style="text-align: center;">  <p>CAUTION</p> </div> <p>USE CARE IN REMOVING AND INSTALLING TORQUEMETER TUBE ASSEMBLY IN MAST TO PREVENT DAMAGE TO CADMIUM PLATING OF MAST INNER DIAMETER AND TO AVOID DAMAGE TO SPLINE TEETH AT THE LOWER END OF THE TORQUE TUBE.</p> <p>8. Remove torquemeter tube assembly and plug at upper end of mast from the mast inside diameter.</p> <div style="text-align: center;"> <p>NOTE</p> <p>Mark an index on the torque multiplier wrench to determine if the upper mast bearing nut rotation occurs.</p> </div> <p>9. Check the torque on the upper mast bearing nut 412-040-104-101 or 412-040-104-103 by applying torque in increasing torque direction. Do not torque more than 1400 foot-pounds (1898 Nm) for -101 nut or 900 foot-pounds (1220 Nm) for -103 nut.</p> <p>10. If rotation is evidenced at torque less than the values above, remove the nut and mast bearing. Examine bearing inside diameter and mast journal for evidence of rotation and/or fretting. Visually examine the inside diameter and outside diameter of the mast for evidence of corrosion and/or mechanical damage. Pay attention for corrosion at the journal, the annular groove and the (bearing nut) threads above the bearing. Record that the reason for the disassembly was low nut torque. Replace any discrepant parts.</p>		



SPECIAL INSPECTIONS

5-36. EACH 2500 OR 3000 HOURS OR 5 YEARS OF MAIN ROTOR MAST (412-040-366-109 AND SUBSEQUENT) OPERATION (CONT)

DATA REFERENCE	INSPECTION TASK DESCRIPTION	INITIAL	
		MECH	OTHER
	<p style="text-align: center;">NOTE</p> <p>Step 11 is applicable to Post-TB 412-14-231 mast assembly and step 12 is applicable to Pre-TB 412-14-231 mast assembly only.</p> <p>11. For Post-TB 412-14-231 mast configuration, if there was no evidence of nut rotation at step 10, visually examine the inside diameter and outside diameter of the mast for evidence of corrosion and/or mechanical damage. Continue with step 13.</p> <p>12. For Pre-TB 412-14-231 mast configuration, if there was no evidence of nut rotation at step 10, remove the nut and inspect for corrosion and/or mechanical damage. It is not necessary to remove the mast bearing. Visually examine the inside diameter and outside diameter of the mast for evidence of corrosion and/or mechanical damage. Pay attention for corrosion on the journal above the bearing, the visible portions of the bearing, the annular groove and the (bearing nut) threads above the bearing. Replace any discrepant parts.</p> <p>13. Assemble main rotor mast assembly.</p> <p>14. Install torquemeter tube assembly and plug.</p> <p style="padding-left: 20px;">a. For mast assemblies 412-040-366-109, Bell Helicopter will align the spline teeth in the torquemeter tube assembly relative to those in the lower torquemeter rotor. The alignment procedure used for the spline teeth depends on the serial number of the mast assembly and the part number of the monopole sensor used with the mast assembly.</p> <p style="padding-left: 20px;">b. For mast assemblies 412-040-366-111 and subsequent, align the spline teeth in the torquemeter tube assembly relative to the spline teeth in the lower torquemeter rotor using tool 412-240-028-101.</p> <p>15. Install main rotor mast assembly.</p>		

SPECIAL INSPECTIONS

5-37. EACH 2500 HOURS OF TAIL ROTOR DRIVE SYSTEM OPERATION

DATA REFERENCE	INSPECTION TASK DESCRIPTION	INITIAL	
		MECH	OTHER
Chapter 65	<p>DATE: _____ W.O. _____</p> <p>FACILITY: _____</p> <p>HELICOPTER S/N: _____</p> <p>REGISTRY NO.: _____</p> <p>TOTAL TIME: _____</p> <p>SIGNATURE: _____</p> <p style="text-align: center;">NOTE</p> <p>Accomplish each 2500 hours of tail rotor drive system operation on helicopters S/N 36020 through 36999, S/N 37002 through 37999, S/N 38001 through 38999, S/N 39101 through 39999, and helicopters modified by 412-570-001-103 or Post BHT-412-SI-74 (412SP to 412HP Upgrade).</p> <p><u>TAIL ROTOR DRIVESHAFT</u></p> <p>1. Check torque of nuts at laminated disc couplings by applying torque. Do not exceed 280 inch-pounds (31.64 Nm). If nut rotates under torque, inspect attachment hardware, driveshafts, disc packs, couplings, and adapters, as applicable, for serviceability. Replace as required.</p> <p>2. Visually examine laminated disc assemblies for separation, deflection, distortion, cracks, missing sections, and correct installation of bolts and washers.</p>		

SPECIAL INSPECTIONS

5-37. EACH 2500 HOURS OF TAIL ROTOR DRIVE SYSTEM OPERATION (CONT)

DATA REFERENCE	INSPECTION TASK DESCRIPTION	INITIAL MECH OTHER	
	<p>a. Visually examine exterior surface and TEMP-PLATE overtemperature indicators of outer coupling for discoloration and evidence of overheating. A change in color of TEMP-PLATES (from white to black) indicates a possible overheat condition and/or component degradation. The cause of TEMP-PLATES and/or exterior surface discoloration shall be determined and corrected prior to continued operation.</p> <p style="text-align: center;">NOTE</p> <p>Refer to BHT-412-CR&O for disassembly, cleaning, assembly, inspection procedures, and wear and damage limits.</p> <p>b. Remove retaining ring, end plate, and packing. Remove retaining ring, retainer, and packing.</p> <p>c. Check torque of bolt 204-040-612 by applying torque. Do not exceed 100 foot-pounds (136 Nm). If bolt turns under torque, inspect for serviceability after removal. Replace as required. After torque verification, remove bolt 204-040-612.</p> <p>d. Remove outer coupling and inner crown tooth coupling.</p> <p>e. Remove inner coupling from outer coupling. Remove retainer 214-040-633/427-044-121, seal 214-040-812/412-340-004, and housing 214-040-634/427-044-113 from female coupling as an assembly. Using an arbor press, ensure retainer 214-040-633/427-044-121 is fully seated in housing 214-040-634/427-044-113.</p> <p>f. Remove all old grease from inner outer coupling teeth using clean, lint-free cloth. Clean teeth thoroughly.</p> <p>g. Visually inspect internal spline teeth of male coupling and mating spline of gear for evidence of fretting and/or corrosion. Visually inspect teeth of inner and outer coupling for evidence of wear, pitting, dings, or chipped teeth.</p> <p>h. Inspect seal 214-040-812/412-340-004, in place for distortion, cuts, tears, and deterioration.</p> <p>i. Visually examine wear sleeve of male coupling for evidence of wear and/or overheating.</p>		

SPECIAL INSPECTIONS

5-37. EACH 2500 HOURS OF TAIL ROTOR DRIVE SYSTEM OPERATION (CONT)

DATA REFERENCE	INSPECTION TASK DESCRIPTION	INITIAL	
		MECH	OTHER
BHT-412-CR&O Chapter 65	<p>j. Inspect seal housing for damage that could cause leakage of lubricant.</p> <p>k. Inspect end plate for damage that could cause leakage of lubricant.</p> <p>3. Assemble and lubricate intermediate gearbox output quill coupling.</p> <p><u>HANGER ASSEMBLIES</u></p> <p>1. Visually examine exterior surfaces of hanger assembly and adjacent area surfaces for evidence of grease leakage.</p>		
BHT-412-CR&O	<p>NOTE</p> <p>Refer to the BHT-412-CR&O for disassembly, cleaning, assembly, inspection procedures, and wear and damage limits.</p> <p>2. Clean external surfaces of hanger assembly.</p> <p>3. Visually inspect hanger assembly as follows:</p> <p>a. Inspect hanger for evidence of wear, dents, enlarged mounting slots, fretting, or corrosion.</p>		
	<p>WARNING</p> <p>CAUSE OF ANY DISCOLORATION SHALL BE DETERMINED AND CORRECTED PRIOR TO NEXT FLIGHT.</p> <p>b. Inspect hanger exterior surfaces for discoloration and overheat condition. A change in color indicates a possible overheat condition and/or component degradation. The cause of exterior surface discoloration shall be determined and corrected prior to continued operation.</p>		

SPECIAL INSPECTIONS

5-37. EACH 2500 HOURS OF TAIL ROTOR DRIVE SYSTEM OPERATION (CONT)

DATA REFERENCE	INSPECTION TASK DESCRIPTION	INITIAL	
		MECH	OTHER
Chapter 65	<p>c. Inspect shaft and flange for evidence of wear, nicks, dents, enlarged holes, and cracks.</p> <p>d. Inspect bearing for grease leakage.</p> <p>e. Inspect bearing in hanger for smoothness of rotation and binding by manually rotating bearing.</p> <p>4. Lubricate hanger assembly.</p> <p><u>COUPLING ASSEMBLY (412-040-601-101/-109)</u></p> <p>1. Visually examine exterior surfaces of coupling assembly and adjacent area surfaces for evidence of grease leakage.</p> <p>2. Remove coupling assembly 412-040-601-101/-109 from helicopter.</p>		
BHT-412-CR&O	<p style="text-align: center;">NOTE</p> <p>Refer to the BHT-412-CR&O for disassembly, cleaning assembly, inspection procedures, and wear and damage limits.</p> <p>3. Clean external surfaces of coupling assembly.</p> <p>4. Visually inspect coupling assembly, as follows:</p> <div style="text-align: center; border: 1px solid black; padding: 5px; width: fit-content; margin: 10px auto;"> <p>WARNING</p> </div> <p>CAUSE OF ANY DISCOLORATION SHALL BE DETERMINED AND CORRECTED PRIOR TO NEXT FLIGHT.</p> <p>a. Inspect coupling TEMP-PLATE overtemperature indicator and exterior surfaces for discoloration and overheat condition. A change in color of TEMP-PLATES (from white to black) indicates a possible overheat condition and possible component degradation. The cause of indicator or exterior surface discoloration shall be determined and corrected prior to continued operation.</p>		

SPECIAL INSPECTIONS

5-37. EACH 2500 HOURS OF TAIL ROTOR DRIVE SYSTEM OPERATION (CONT)

DATA REFERENCE	INSPECTION TASK DESCRIPTION	INITIAL	
		MECH	OTHER
BHT-412-CR&O	<p>b. Inspect flange and outer coupling for nicks, dents, enlarged holes, and cracks.</p> <p>5. Disassemble coupling assembly for internal inspection as follows:</p> <p>a. While holding end plate against spring, remove retaining ring. Remove end plate and spring. Visually examine end plate, spring, and retaining ring for evidence of wear and/or corrosion.</p> <p>b. Remove cotter pin. Check torque on nut by applying torque. Do not exceed 50 inch-pounds (5.65 Nm). If nut rotates under torque, inspect attachment hardware for serviceability. Replace as required.</p> <p>c. Remove bolt, nut, and plates. Visually examine faying surfaces of plates for evidence of wear and/or corrosion. Remove inner and outer couplings and sleeve from shaft.</p> <p>d. Remove inner coupling from outer coupling. Remove retaining ring. Remove retainer, seal, and housing from female coupling as an assembly. Using an arbor press, ensure retainer is fully seated in housing.</p> <p>e. Remove sleeve from inner coupling and inspect for evidence of wear and/or corrosion.</p> <p>f. Remove all old grease from inner and outer coupling teeth using a clean, lint-free cloth. Clean teeth thoroughly.</p> <p>g. Visually inspect splines of shaft and inner coupling for evidence of fretting, wear, and/or corrosion. Visually inspect mating surfaces of male coupling and sleeve for evidence of wear and/or corrosion. Visually inspect teeth of inner and outer couplings for evidence of wear, pitting, dings, dents, or chipped teeth.</p> <p>h. Inspect seal 214-040-812/412-340-004, in place for distortion, cuts, tears, and deterioration.</p> <p>i. Inspect seal housing for damage that could cause leakage of lubricant.</p>		

SPECIAL INSPECTIONS

5-37. EACH 2500 HOURS OF TAIL ROTOR DRIVE SYSTEM OPERATION (CONT)

DATA REFERENCE	INSPECTION TASK DESCRIPTION	INITIAL	
		MECH	OTHER
BHT-412-CR&O	<p>j. Inspect end plate for damage that could cause leakage of lubricant.</p> <p>6. Assemble and lubricate coupling assembly.</p> <p>7. Replace TEMP-PLATE overtemperature indicators if discolored or damaged.</p>		
Chapter 65	<p>8. Install coupling assembly on helicopter.</p> <p><u>COUPLING ASSEMBLY (412-040-601-105/-107/-111)</u></p>		
Chapter 65 BHT-412-CR&O	<p>1. Visually examine exterior surfaces of coupling assembly and adjacent area surfaces for evidence of grease leakage.</p> <p>2. Remove coupling assembly from helicopter.</p> <p style="text-align: center;">NOTE</p> <p style="text-align: center;">Refer to the BHT-412-CR&O for disassembly, cleaning, assembly, inspection procedures, and wear and damage limits.</p>		
BHT-412-CR&O	<p>3. Clean external surfaces of coupling assembly.</p>		
BHT-412-CR&O	<p>4. Visually inspect coupling assembly as follows:</p> <p style="padding-left: 20px;">a. Inspect hanger for evidence of wear, dents, enlarged mounting slots, fretting, or corrosion.</p> <div style="text-align: center; margin: 10px 0;"> <div style="border: 1px solid black; padding: 2px 5px; display: inline-block;">WARNING</div> </div> <p style="text-align: center;">CAUSE OF ANY DISCOLORATION SHALL BE DETERMINED AND CORRECTED PRIOR TO NEXT FLIGHT.</p>		

SPECIAL INSPECTIONS

5-37. EACH 2500 HOURS OF TAIL ROTOR DRIVE SYSTEM OPERATION (CONT)

DATA REFERENCE	INSPECTION TASK DESCRIPTION	INITIAL	
		MECH	OTHER
BHT-412-CR&O	<p>b. Inspect hanger and outer coupling TEMP-PLATES overtemperature indicators and exterior surfaces for discoloration and overheat condition. A change in color of TEMP-PLATES (from white to black) indicates a possible overheat condition and/or possible component degradation. The cause of discoloration shall be determined and corrected prior to continued operation.</p> <p>c. Inspect shaft and outer coupling for nicks, dents, enlarged holes, and cracks.</p> <p>d. Inspect bearing for grease leakage and dislocation of bearing seals.</p> <p>e. Inspect bearing in hanger for smoothness of rotation and binding by manually rotating bearing.</p> <p>5. Disassemble coupling assembly for internal inspection as follows:</p> <p>a. While holding end plate against spring, remove retaining ring. Remove end plate and spring. Visually examine end plate spring and retaining ring for evidence of wear and/or corrosion.</p> <p>b. Remove cotter pin. Check torque on nut by applying torque. Do not exceed 50 inch-pounds (5.65 Nm). If nut rotates under torque, inspect attachment hardware for serviceability. Replace as required.</p> <p>c. Remove bolt, nut, and plates. Visually examine faying surfaces of plates for evidence of wear and/or corrosion. Remove inner and outer couplings and sleeve from shaft.</p> <p>d. Remove inner coupling from outer coupling. Remove retaining ring. Remove retainer, seal, and housing from female coupling as an assembly. Using an arbor press, ensure retainer is fully seated in housing.</p> <p>e. Remove sleeve from inner coupling and inspect for evidence of wear and/or corrosion.</p>		

SPECIAL INSPECTIONS

5-37. EACH 2500 HOURS OF TAIL ROTOR DRIVE SYSTEM OPERATION (CONT)

DATA REFERENCE	INSPECTION TASK DESCRIPTION	INITIAL MECH OTHER	
<p>BHT-412-CR&O</p> <p>Chapter 65</p>	<div style="text-align: center; border: 2px dashed black; padding: 5px; width: fit-content; margin: 0 auto;"> <p>CAUTION</p> </div> <p>DO NOT USE SOLVENT TO CLEAN COUPLING TEETH. SOLVENT MAY LEAVE A RESIDUE, WHICH PREVENTS LUBRICANTS FROM ADHERING TO COUPLING.</p> <p>f. Remove all old grease from inner and outer coupling teeth using a clean, lint-free cloth. Clean teeth thoroughly.</p> <p>g. Visually inspect splines of shaft and inner coupling for evidence of fretting, wear, and/or corrosion. Visually inspect mating surfaces of male coupling and sleeve for evidence of wear and/or corrosion. Visually inspect teeth of inner and outer coupling for evidence of wear, pitting, dents, or chipped teeth.</p> <p>h. Inspect end plate for damage that could cause leakage of lubricant.</p> <p>i. Inspect seal, in place, for distortions, cuts, tears, and deterioration.</p> <p>j. Inspect seal housing for damage that could cause leakage of lubricant.</p> <p>6. Assemble and lubricate bearing and coupling assembly.</p> <p>7. Replace TEMP-PLATE overtemperature indicators if discolored or damaged.</p> <p>8. Install assembly on helicopter.</p>		

SPECIAL INSPECTIONS

5-37. EACH 2500 HOURS OF TAIL ROTOR DRIVE SYSTEM OPERATION (CONT)

DATA REFERENCE	INSPECTION TASK DESCRIPTION	INITIAL	
		MECH	OTHER
Chapter 65 BHT-412-CR&O	<p><u>TAIL ROTOR GEARBOX</u></p> <p style="text-align: center;">NOTE</p> <p>Refer to the BHT-412-CR&O for disassembly, cleaning, assembly, inspection procedures, and wear and damage limits.</p>		
	<ol style="list-style-type: none"> 1. Visually inspect exterior surface of gearbox and adjacent area for evidence of leaking, seepage, corrosion, and damage. 2. Remove input quill adapter spring lock and retainer. Check torque of bolt using increasing torque. Do not exceed 80 foot-pounds (108 Nm). If bolt turns under torque, inspect for serviceability. 3. Install input quill adapter retainer and spring lock. 		



SPECIAL INSPECTIONS

5-38. EACH 3000 HOURS OR 5 YEARS OF MAIN ROTOR MAST (412-040-366-103 AND -105) OPERATION

DATA REFERENCE	INSPECTION TASK DESCRIPTION	INITIAL MECH OTHER	
<p>Chapter 63 BHT-412-CR&O</p>	<p>DATE: _____ W.O. _____</p> <p>FACILITY: _____</p> <p>HELICOPTER S/N: _____</p> <p>REGISTRY NO.: _____</p> <p>TOTAL TIME: _____</p> <p>SIGNATURE: _____</p> <p style="text-align: center;">NOTE</p> <p>Accomplish each 3000 hours or 5 years of main rotor mast (412-040-366-103 and -105) operation on helicopters S/N 33001 through 33213 and S/N 36001 through 36019 not modified by 412-570-001-103 or BHT-412-SI-74 (412SP to 412HP Upgrade).</p> <p><u>MAIN ROTOR MAST (412-040-366-103 AND 412-040-366-105)</u></p> <p style="text-align: center;">NOTE</p> <p>Prior to removing mast assembly from transmission, check chip detector, located in top case, for evidence of debris. Presence of ferrous foreign material on chip detector will require additional inspection to determine origin.</p> <p>1. Remove main rotor mast assembly from transmission.</p>		



SPECIAL INSPECTIONS

5-38. EACH 3000 HOURS OR 5 YEARS OF MAIN ROTOR MAST (412-040-366-103 AND -105) OPERATION (CONT)

DATA REFERENCE	INSPECTION TASK DESCRIPTION	INITIAL MECH OTHER	
	<div style="text-align: center; border: 2px dashed black; padding: 5px; margin-bottom: 10px;"> CAUTION </div> <p style="text-align: center;">DO NOT STAND OR LAY MAST HORIZONTALLY WITH MAST BEARING RETAINING PLATE SUPPORTING WEIGHT OF MAST.</p> <ol style="list-style-type: none"> 2. Place main rotor mast assembly in horizontal position on padded support, such as V blocks. 3. Remove lock ring, mast bearing retaining plate, and shim. 4. Visually inspect seal for signs of overheating, cracking, wear, or damage. 5. Check mast bearing for smooth rolling and freedom from binding. 6. Visually examine lower mast bearing inner race for scratches, dents, corrosion, pitting, spalling, roller skidding, or scoring. 7. Visually examine splines on mast for dents, wear, or damage. <p style="text-align: center;">NOTE</p> <p style="text-align: center;">Mark an index on the torque multiplier wrench to determine if the upper mast bearing nut rotation occurs.</p> <ol style="list-style-type: none"> 8. Check the torque on the upper mast bearing nut 412-040-104-101 or 412-040-104-103 by applying torque in increasing torque direction. Do not torque more than 1400 foot-pounds (1898 Nm) for -101 nut or 900 foot-pounds (1220 Nm) for -103 nut. 		



SPECIAL INSPECTIONS

5-38. EACH 3000 HOURS OR 5 YEARS OF MAIN ROTOR MAST (412-040-366-103 AND -105) OPERATION (CONT)

DATA REFERENCE	INSPECTION TASK DESCRIPTION	INITIAL	
		MECH	OTHER
	<p>9. If rotation is evidenced at torque less than the values above, remove the nut and mast bearing. Examine bearing inside diameter and mast journal for evidence of rotation and/or fretting. Visually examine the inside diameter and outside diameter of the mast for evidence of corrosion and/or mechanical damage. Pay attention for corrosion at the journal, the annular groove and the (bearing nut) threads above the bearing. Record that the reason for the disassembly was low nut torque. Replace any discrepant parts.</p> <p style="text-align: center;">NOTE</p> <p style="text-align: center;">Step 10 is applicable to Post-TB 412-14-231 mast assembly and step 11 is applicable to Pre-TB 412-14-231 mast assembly only.</p> <p>10. For Post-TB 412-14-231 mast configuration, if there was no evidence of nut rotation at step 9, visually examine the inside diameter and outside diameter of the mast for evidence of corrosion and/or mechanical damage. Continue with step 12.</p> <p>11. For Pre-TB 412-14-231 mast configuration, if there was no evidence of nut rotation at step 9, remove the nut and inspect for corrosion and/or mechanical damage. It is not necessary to remove the mast bearing. Visually examine the inside diameter and outside diameter of the mast for evidence of corrosion and/or mechanical damage. Pay attention for corrosion on the journal above the bearing, the visible portions of the bearing, the annular groove and the (bearing nut) threads above the bearing. Replace any discrepant parts.</p> <p>12. Assemble main rotor mast assembly.</p>		

SPECIAL INSPECTIONS

5-39. EACH 3000 HOURS OF TRANSMISSION (412-040-002) OPERATION

DATA REFERENCE	INSPECTION TASK DESCRIPTION	INITIAL	
		MECH	OTHER
BHT-412-CR&O	<p>DATE: _____ W.O. _____</p> <p>FACILITY: _____</p> <p>HELICOPTER S/N: _____</p> <p>REGISTRY NO.: _____</p> <p>TOTAL TIME: _____</p> <p>SIGNATURE: _____</p> <p style="text-align: center;">NOTE</p> <p>Accomplish each 3000 hours of transmission 412-040-002 operation on helicopters S/N 33001 through 33213 and S/N 36001 through 36019 not modified by 412-570-001-103 or BHT-412-SI-74 (412SP to 412HP Upgrade).</p> <p><u>TRANSMISSION (412-040-002)</u></p> <ol style="list-style-type: none"> 1. Disassemble transmission sufficiently to remove main input driven gear quill. 2. Remove gear support case and debris collector to gain access to spiral bevel gear retaining bolts. <ol style="list-style-type: none"> a. Using torque wrench, torque check each of the 32 bevel gear retaining bolts for minimum torque of 300 inch-pounds (33.89 Nm). b. If torque value of any one retaining bolt is less than 300 inch-pounds (33.89 Nm), remove bevel gear and inspect mating surfaces of gear and shaft for fretting damage. 		

SPECIAL INSPECTIONS

5-39. EACH 3000 HOURS OF TRANSMISSION (412-040-002) OPERATION (CONT)

DATA REFERENCE	INSPECTION TASK DESCRIPTION	INITIAL	
		MECH	OTHER
	<p>c. The maximum acceptable depth of pitting is 0.0005 inch (0.013 mm). Depth may be measured by using a dial indicator with a needle pointed probe. Pitting of measurable depth is acceptable only in the area on gear or shaft surface outside of diameter of bolt holes. It is not acceptable within 0.10 inch (2.5 mm) of edge of a bolt hole. Damage in excess of these limits is cause for rejection of part.</p>		
BHT-412-CR&O	<p>3. Inspect upper flange surface and pilot diameter of ring gear and mating surfaces of top case fretting and wear.</p>		
BHT-412-CR&O	<p>4. Inspect lower flange surface and pilot diameter of ring gear and mating surfaces of bevel gear support case for fretting and wear.</p> <p>5. Visually check index marks on input pinion and inner race of bearing set for alignment. Inspection may be accomplished with input quill installed by viewing pinion shaft and bearing inner race between pinion teeth and main case.</p> <p style="text-align: center;">NOTE</p> <p>If index marks indicate rotational movement between pinion and inner race of bearing set, remove quill and bearing set, and inspect pinion bearing journal for signs of fretting and bearing inner race spinning. Visually inspect oil holes in input quill sleeve to ensure no foreign material is present. Inspect detail parts to determine cause for bearing inner race rotation and replace parts as required.</p>		
BHT-412-CR&O	<p>6. Inspect bevel gear and main input pinion for general condition and wear pattern.</p>		
BHT-412-CR&O	<p>7. Inspect planetary ring gear, sun gears, and planetary pinions for general condition and wear pattern. Inspect all parts of upper and lower planetary visually for excessive wear and damage. Dimensionally check parts showing evidence of wear or physical damage.</p> <p>8. Remove tail rotor drive quill to gain access to accessory drive and sump gears. Visually inspect accessory case input quill gear and tail rotor drive quill gear for general condition and wear pattern.</p>		

SPECIAL INSPECTIONS

5-39. EACH 3000 HOURS OF TRANSMISSION (412-040-002) OPERATION (CONT)

DATA REFERENCE	INSPECTION TASK DESCRIPTION	INITIAL MECH OTHER	
BHT-412-CR&O	<p>9. Inspect transmission support case lateral mounts as follows:</p> <ul style="list-style-type: none"> a. Remove screws and washers from transmission support case lateral mounts, top and bottom. b. Visually inspect screws for corrosion and thread damage. c. Visually inspect upper washers 204-040-236 and lower washers 204-040-736 for corrosion and/or pitting. d. Visually inspect installed bushings for corrosion and/or pitting. e. Visually inspect transmission support case lateral mount surfaces and threaded holes for mechanical and corrosion damage. <p>10. Perform magnetic particle inspection on lower planetary spider 204-040-785-003.</p> <div style="text-align: center;">  <p>CAUTION</p> </div> <p>USE OF ANY FORM OF LUBRICANT TO FACILITATE INSTALLATION OF GEAR ON SHAFT WILL RESULT IN TORQUE LOSS OF ATTACHMENT BOLTS AND SUBSEQUENT FRETTING DAMAGE.</p> <p style="text-align: center;">NOTE</p> <p>During assembly of spiral bevel gear to shaft, ensure mating surfaces are dry.</p> <p>11. Assemble transmission.</p>		



SPECIAL INSPECTIONS

5-40. EACH 3000 HOURS OF TRANSMISSION (412-040-004/412-040-007/412-040-802) OPERATION

DATA REFERENCE	INSPECTION TASK DESCRIPTION	INITIAL	
		MECH	OTHER
Chapter 63 BHT-412-CR&O	DATE: _____ W.O. _____ FACILITY: _____ HELICOPTER S/N: _____ REGISTRY NO.: _____ TOTAL TIME: _____ SIGNATURE: _____ <p style="text-align: center;">NOTE</p> <p>Accomplish each 3000 hours of transmission 412-040-004/412-040-007/412-040-802 operation on helicopters S/N 36020 through 36999, S/N 37002 through 37999, and helicopters modified by 412-570-001-103 or Post BHT-412-SI-74 (412SP to 412HP Upgrade).</p> <p><u>MAIN TRANSMISSION (412-040-004/412-040-007/412-040-802)</u></p>		
	<p style="text-align: center;">NOTE</p> <p>Refer to the BHT-412-CR&O for disassembly, cleaning, assembly, inspection procedures, wear, and damage limits.</p> <p>1. Visually examine exterior surfaces of rotor brake quill 412-040-123-103 for evidence of oil seeping and/or leaking. Visually examine area of shaft seal for evidence of seal leakage.</p> <p style="text-align: center;">NOTE</p> <p>Do not remove brake disc from drive flange. To facilitate removal of rotor brake quill from transmission, remove nut retaining drive flange and remove disc and flange as an assembly.</p> <p>2. Remove rotor brake quill from transmission. Refer to Component Overhaul Schedule.</p>		
BHT-412-CR&O			

SPECIAL INSPECTIONS

5-40. EACH 3000 HOURS OF TRANSMISSION (412-040-004/412-040-007/412-040-802) OPERATION (CONT)

DATA REFERENCE	INSPECTION TASK DESCRIPTION	INITIAL	
		MECH	OTHER
Chapter 63	<p>3. After input gear quill has been assembled into main case, install rotor brake quill in transmission.</p>		
Chapter 63 BHT-412-CR&O	<p>4. Visually inspect outside of transmission for evidence of corrosion, damage, and oil leaks (including leaking at seals at input, mast, tail rotor output, and accessory quills) before disassembling transmission.</p> <p>5. Drain and strain transmission lubricant. Bag any foreign material found and deliver with transmission for evaluation during this inspection.</p> <p>6. Remove mast chip detector from top case, planetary detector from main case, full flow detector from sump case, and chip detector from bottom of sump case. Visually inspect detectors for cut packings, burrs, bent tubes, and foreign material. Clean detectors as required with MEK (C-309).</p> <p>7. Any foreign material found on detectors or in lubricant shall be evaluated. Inspection may require additional investigation to identify course(s) of foreign material and initiate appropriate action.</p>		
BHT-412-CR&O	<p>8. Disassemble main transmission to accomplish the following:</p> <p style="padding-left: 40px;">a. Remove and inspect the following jet assemblies from transmission and check for evidence of clogging.</p> <p style="padding-left: 80px;">(1) 204-040-262 – Jet No. 2.</p> <p style="padding-left: 80px;">(2) 204-040-326 – Jet No. 3.</p> <p style="padding-left: 80px;">(3) 204-040-288 – Jet No. 5.</p> <p style="padding-left: 80px;">(4) 204-040-135 (2 each) — Jet located in ring gear case.</p> <p style="padding-left: 40px;">b. Remove top case. Inspect mast assembly mating surface, ring gear mating surface, and pilot diameters for fretting and wear.</p>		

SPECIAL INSPECTIONS

5-40. EACH 3000 HOURS OF TRANSMISSION (412-040-004/412-040-007/412-040-802) OPERATION (CONT)

DATA REFERENCE	INSPECTION TASK DESCRIPTION	INITIAL	
		MECH	OTHER
BHT-412-CR&O	<p>9. Planetary component removal:</p> <p>a. Remove upper planetary assembly 204-040-360 and adapter 412-040-107 as an assembly.</p> <p>b. Remove retaining ring M27426-1220C and adapter 412-040-107 from planetary assembly 204-040-360. Do not disassemble planetary assembly.</p> <p>c. Remove liner 204-040-337, bearing 204-040-135, and extension 412-040-109 as an assembly. Do not disassemble.</p> <p>d. Remove ring gear assembly 205-040-231.</p> <p>e. Remove upper sun gear 412-040-230, deflector 204-040-378, and retaining ring RR687L as an assembly.</p> <p>f. Remove lower planetary assembly 204-040-784. Do not disassemble.</p> <p>g. Remove liner 204-040-338, bearing 204-040-135, and liner 204-040-257 as an assembly. Do not disassemble.</p> <p>h. Remove lower sun gear 205-040-229.</p> <p>10. Planetary component inspection:</p> <p>a. Visually inspect all parts of planetary assembly for evidence of wear and/or damage.</p> <p>b. Visually inspect gear tooth contact patterns on the eight pinion assemblies in upper planetary assembly. It is normal for ring gear meshing side of planet pinions to have a double wear pattern. Check bearings for smoothness and freedom from binding by rotating pinion assemblies. Visually inspect all lockwire provisions.</p> <p>c. Visually inspect external and internal spline teeth of adapter 412-040-107 for excessive wear and general condition.</p> <p>d. Check planetary support liners and bearings 204-040-135 for smoothness and freedom of rotation by manually turning.</p>		

SPECIAL INSPECTIONS

5-40. EACH 3000 HOURS OF TRANSMISSION (412-040-004/412-040-007/412-040-802) OPERATION (CONT)

DATA REFERENCE	INSPECTION TASK DESCRIPTION	INITIAL MECH OTHER	
	<p>e. Visually inspect upper flange surface and upper pilot diameter and lower flange surface and lower pilot diameter of ring gear 205-040-231 for fretting and wear. Visually inspect upper and lower gear teeth contact patterns for evidence of pitting, scoring, wear, or damage.</p> <p>f. Visually inspect upper sun gear 412-040-230 teeth for wear, damage, and contact pattern.</p> <div style="text-align: center;">  <p>CAUTION</p> </div> <p>DO NOT USE SOLVENT TO CLEAN COUPLING TEETH. SOLVENT MAY LEAVE A RESIDUE, WHICH PREVENTS LUBRICANTS FROM ADHERING TO COUPLING.</p> <p>g. Visually inspect gear tooth contact pattern on the four pinion assemblies in lower planetary assembly. It is normal for ring gear meshing side of planet pinions to have a double wear pattern. Check bearings for smoothness and freedom from binding by rotating the four pinion assemblies. Visually inspect all lockwire provisions.</p> <p>h. Visually inspect lower sun gear 205-040-229 teeth for wear, damage, and contact pattern.</p> <p>11. Check backlash in three places approximately 120° apart between gear 412-040-701 and pinion 412-040-700 using backlash tool 412-240-006. Record backlash on inspection log.</p> <p>12. Visually inspect manifold assembly 204-040-393. Remove, clean, and inspect jet No. 7 for evidence of clogging.</p> <p>13. Remove quill assembly 412-040-362 from main case. Do not disassemble. Visually inspect mating flanges and pilot diameters for corrosion, fretting, and wear. Visually inspect all lockwire provisions. Check duplex bearing for smoothness and freedom of rotation by manually turning gear 412-040-701. Visually check index marks on gear and inner race of bearing set 205-040-245 for alignment.</p>		

SPECIAL INSPECTIONS

5-40. EACH 3000 HOURS OF TRANSMISSION (412-040-004/412-040-007/412-040-802) OPERATION (CONT)

DATA REFERENCE	INSPECTION TASK DESCRIPTION	INITIAL	
		MECH	OTHER
BHT-412-CR&O	<p>a. If the index marks indicate movement between gear and inner race of bearing set, remove gear 412-040-701, plate 204-040-357, shim 204-040-348, bearing set 205-040-245, and shim 204-040-350.</p> <p>b. Visually inspect inside diameter of bearing set 205-040-245 for signs of spinning. Visually inspect bearing journal on gear 412-040-701 for sign of fretting. Inspect detail components to determine cause for inner race rotation.</p> <p>14. Visually inspect drive and coast side of gear 412-040-701 teeth for wear, scoring, pitting, and contact pattern. Visually inspect upper and lower spline teeth for excessive wear and/or damage.</p> <p>15. Visually inspect roller bearing race on lower end of gear for evidence of skidding, scoring, pitting, or damage.</p> <p>16. Visually inspect splines on the upper and lower end of gear for damage and/or wear.</p> <p>17. Visually inspect drive and coast side of pinion 412-040-700 teeth for excessive wear, scoring, pitting, and contact pattern. Visually inspect vibro-etched index marks on pinion 412-040-700 and bearing set 214-040-118 for alignment. Inspection may be accomplished with input quill installed by viewing pinion shaft and bearing inner race between teeth and main case.</p> <p>a. If index marks indicate rotational movement between pinion and inner race of bearing set, quill 412-040-263 shall be removed from main case. Disassemble quill to remove pinion 412-040-700 and bearing set 214-040-118.</p> <p>b. Visually inspect pinion bearing journal for signs of fretting and bearing inner race spinning. Clean sleeve 412-040-137 with drycleaning solvent (C-304). Visually verify oil holes in sleeve are free of any foreign material. Inspect detail components to determine cause for inner race rotation.</p> <p>18. Visually inspect teeth of pinion 412-040-302 in quill assembly 204-040-379 for wear, scoring, pitting, and gear tooth contact pattern. Inspect internal spline of pinion for wear and general condition.</p>		

SPECIAL INSPECTIONS

5-40. EACH 3000 HOURS OF TRANSMISSION (412-040-004/412-040-007/412-040-802) OPERATION (CONT)

DATA REFERENCE	INSPECTION TASK DESCRIPTION	INITIAL	
		MECH	OTHER
BHT-412-CR&O	<p>19. Check bearing set 204-040-424 for smoothness and freedom from binding by rotating pinion 412-040-302 by hand.</p> <p>20. Remove main case assembly. Visually inspect upper and lower flanges and pilot diameters for evidence of fretting and wear.</p> <p>21. Visually inspect the rollers of bearing 204-040-271 for evidence of skidding, scoring, and end damage. Do not remove bearing from case.</p> <p>22. Visually inspect the rollers of 205-040-249 bearing for any damage. Do not remove from main case.</p> <p>23. Inspect 212-040-208 quill assembly:</p> <ul style="list-style-type: none"> a. Remove drive and sump assembly 212-040-365 from support case assembly 212-040-054. b. Remove adapter 212-040-206. Inspect both splines for evidence of damage and/or wear. c. Check installation of cotter pin six places. d. Visually inspect for proper installation of retainer. e. Visually inspect gear 212-040-201 teeth and pinion 212-040-202 teeth for evidence for wear, scoring, and pitting. f. Manually turn pinion and check bearings for smoothness of rotation and freedom from binding. 		
BHT-412-CR&O	<p>24. Inspect components in case assembly 212-040-054:</p> <ul style="list-style-type: none"> a. Visually inspect mating flange and pilot diameter of support case at main case joint for evidence of corrosion, fretting, and/or wear. b. Remove lift link fitting. c. Visually inspect lift link fitting pads for evidence of fretting and wear. d. Visually inspect bearing rollers for evidence of damage. 		

SPECIAL INSPECTIONS

5-40. EACH 3000 HOURS OF TRANSMISSION (412-040-004/412-040-007/412-040-802) OPERATION (CONT)

DATA REFERENCE	INSPECTION TASK DESCRIPTION	INITIAL	
		MECH	OTHER
BHT-412-CR&O	<p>e. Remove screws and washers from transmission support case lateral mounts, top and bottom.</p> <p>f. Visually inspect screws for corrosion and thread damage.</p> <p>g. Visually inspect upper washers 204-040-236 and lower washers 204-040-736 for corrosion and/or pitting.</p> <p>h. Visually inspect installed bushings for corrosion and/or pitting.</p> <p>i. Visually inspect transmission support case lateral mount surfaces and threaded holes for mechanical and corrosion damage.</p> <p>25. Inspect components in drive sump assembly 212-040-365:</p> <p>a. Inspect mating surface and pilot diameter for evidence of fretting and wear.</p> <p>b. Remove and inspect sump output quill assembly. Do not disassemble.</p> <p>c. Visually inspect pinion 212-040-151 teeth for evidence of wear, scoring, and pitting. Inspect tooth contact pattern.</p> <p>d. Check freedom from binding and smoothness of roll of bearings by rotating pinion gear by hand.</p> <p>e. Visually inspect tail rotor input gear teeth for evidence of wear, scoring, and pitting through the output quill bore. Inspect gear tooth contact pattern. Do not remove input quill.</p> <p>f. Check freedom from binding and smoothness of roll of bearings by rotating pinion by hand.</p> <p>g. Remove oil pump and visually examine spline for general condition. Rotate pump by hand and check for freedom of rotation.</p> <p>h. Remove accessory quill (hydraulic and tach drive). Visually examine pilot diameters and mating flanges for evidence of wear and/or corrosion.</p>		

SPECIAL INSPECTIONS

**5-40. EACH 3000 HOURS OF TRANSMISSION (412-040-004/412-040-007/412-040-802)
OPERATION (CONT)**

DATA REFERENCE	INSPECTION TASK DESCRIPTION	INITIAL	
		MECH	OTHER
BHT-412-CR&O	<p>i. Visually inspect hydraulic pump and tachometer drive gear for excessive wear, scoring, and pitting. Inspect tooth contact pattern.</p> <p>j. Check freedom from binding and smoothness of roll of bearings by manually rotating gear 212-040-149.</p> <p>k. Remove, inspect, and clean, chip detector 212-040-122 and screen assembly 204-040-237 for foreign material and No. 4 oil jet for evidence of clogging.</p> <p>l. Visually examine oil pump shaft, through pump bore in case, for general condition of lower spines.</p> <p>26. Assemble transmission.</p>		

SPECIAL INSPECTIONS

5-41. 3600 HOURS TOTAL AIRFRAME TIME AND EACH 300 HOURS/12 MONTHS INSPECTION

DATA REFERENCE	INSPECTION TASK DESCRIPTION	INITIAL MECH OTHER	
TB 412-88-66	<p>DATE: _____ W.O. _____</p> <p>FACILITY: _____</p> <p>HELICOPTER S/N: _____</p> <p>REGISTRY NO.: _____</p> <p>TOTAL TIME: _____</p> <p>SIGNATURE: _____</p> <p style="text-align: center;">NOTE</p> <p>For helicopters S/N 33001 through 33179 with main beam cap 205-030-186-005 installed, accomplish at 3600 hours total airframe time and each 300 hours or 12 months thereafter, whichever occurs first. If main beam cap 205-030-186-005 has been replaced, use replacement cap total time in lieu of helicopter total time.</p> <p>This inspection is not required if main beam cap 205-030-186-005 has been replaced with main beam cap 205-030-186-101.</p> <p><u>MAIN BEAM CAP</u></p> <p>Inspect main beam cap 205-030-186-005 as follows:</p> <ol style="list-style-type: none"> 1. Remove components as necessary to gain access to main beam cap between FS 164 and 168. 2. Clean exposed area of main beam cap. 3. Inspect cap for crack(s) using a bright light and a 3X magnifying glass. 4. Log inspection in helicopter log book. 5. Replace components that were removed to gain access. 		

SPECIAL INSPECTIONS

5-42. EACH 3000 HOURS OR 5 YEARS OF TRANSMISSION MOUNT ASSEMBLY (204-031-927) AND FRICTION DAMPER ASSEMBLY (204-031-920) OPERATION

DATA REFERENCE	INSPECTION TASK DESCRIPTION	INITIAL MECH OTHER	
	<p>DATE: _____ W.O. _____</p> <p>FACILITY: _____</p> <p>HELICOPTER S/N: _____</p> <p>REGISTRY NO.: _____</p> <p>TOTAL TIME: _____</p> <p>SIGNATURE: _____</p> <p style="text-align: center;">NOTE</p> <p>Accomplish each 3000 hours or 5 years of transmission mount assembly (204-031-927) and friction damper assembly (204-031-920) operation, whichever occurs first.</p> <p><u>TRANSMISSION MOUNT ASSEMBLY</u></p> <ol style="list-style-type: none"> 1. Remove mount assembly. 2. Do a detailed inspection of mount assembly. <p><u>TRANSMISSION AFT FRICTION DAMPER ASSEMBLY</u></p> <ol style="list-style-type: none"> 1. Remove friction damper assembly. 2. Do a detailed inspection of friction damper assembly. 		
Chapter 63			
Chapter 63			



SPECIAL INSPECTIONS

5-43. EACH 10 YEAR COLLECTIVE STICK TUBE INSPECTION

DATA REFERENCE	INSPECTION TASK DESCRIPTION	INITIAL	
		MECH	OTHER
Chapter 67 BHT-412-CR&O BHT-412-SI-44 TB 412-87-60	DATE: _____ W.O. _____ FACILITY: _____ HELICOPTER S/N: _____ REGISTRY NO.: _____ TOTAL TIME: _____ SIGNATURE: _____		
	<p style="text-align: center;">NOTE</p> <p style="text-align: center;">Accomplish each 10 years collective stick tube inspection on helicopters.</p> <p><u>FLIGHT CONTROLS</u></p> <ol style="list-style-type: none"> 1. Disassemble pilot and copilot (if installed) collective stick(s) to the extent necessary to remove throttle twist grips. 2. Referring to Figure 5-9, visually inspect stick tube for cracks using a 3X magnifying glass and a bright light. Pay particular attention to the base of the throttle slots that form the twist grip stops. 3. If a crack is found, replace stick tube. 4. Reassemble pilot and copilot (if installed) collective stick(s). 5. Check throttle controls for proper operation. 6. Check collective controls for proper operation. 		



CONDITIONAL INSPECTIONS

5-44. CONDITIONAL INSPECTION

Perform applicable conditional inspection of helicopter after hard landing, after blade strike or other rotating system torque spike, overspeed, overtorque, compressor stall or surge, lightning strike, and after engine combining gearbox clutch non-engagement, misengagement, or in-flight slippage.

If overhaul evaluation is specified, complete both the conditional inspection and normal inspection procedures (as applicable) for that component listed in BHT-412-CR&O.



CONDITIONAL INSPECTIONS

5-45. AFTER HARD LANDING

DATA REFERENCE	INSPECTION TASK DESCRIPTION	INITIAL	
		MECH	OTHER
	<p>DATE: _____ W.O. _____</p> <p>FACILITY: _____</p> <p>HELICOPTER S/N: _____</p> <p>REGISTRY NO.: _____</p> <p>TOTAL TIME: _____</p> <p>SIGNATURE: _____</p> <p style="text-align: center;">NOTE</p> <p>Accomplish after hard landing.</p> <p>Evaluate components removed from a helicopter following a hard landing as an interrelated group. Make entries in component records of each component removed to cross reference part and serial numbers of other drive system components removed for evaluation.</p> <p>Hard landing is defined as any accident or incident in which ground impact of helicopter results in yielding or cracking of mounting lugs of transmission support case or noticeable yielding or cracking of fuselage pylon support structure, landing gear, or tailboom attachment structure. This definition is confined only to those accidents not involving sudden stoppage of main rotor or tail rotor.</p> <p><u>AFTER HARD LANDING</u></p> <p>1. If a hard landing is suspected, accomplish the following:</p> <p style="padding-left: 40px;">a. Inspect main and tail rotor blades for evidence of strike damage. If such evidence is found on either rotor, perform Sudden Stoppage (power on or off).</p> <p style="padding-left: 40px;">b. Visually inspect underside of fuselage and tailboom for evidence of ground contact.</p>		



CONDITIONAL INSPECTIONS

5-45. AFTER HARD LANDING (CONT)

DATA REFERENCE	INSPECTION TASK DESCRIPTION	INITIAL	
		MECH	OTHER
Chapter 32	<p>c. Perform landing gear deflection check.</p> <p>(1) If crosstubes have yielded, remove landing gear and inspect support and attaching structure for signs of yielding or other damage. Replace yielded crosstube and aft crosstube support beam pivot bolt.</p> <p>(2) If supports and attaching structure are not damaged, replace damaged landing gear components.</p> <p>d. Remove mast adapter lower cone and inspect lower cone seat for damage.</p> <p>e. Inspect area around pylon mounts for loose rivets or other damage.</p> <p>f. Inspect tailboom and fuselage attachment for loose rivets, cracks, or other damage.</p> <p>g. If no damage other than yielded landing gear crosstubes has been found at this point, a true hard landing probably did not occur. Complete a 25 hour inspection and return helicopter to flight status provided no further evidence of damage is found.</p> <p>h. If damage is more extensive than landing gear crosstube yielding, a hard landing has occurred. Comply with requirements of step 2 through step 4.</p> <p>2. If a hard landing has occurred, the following steps shall be accomplished:</p>		
BHT-412-CR&O	<p>a. Remove and perform an overhaul evaluation inspection of following components:</p> <p>(1) Mast assembly.</p>		



CONDITIONAL INSPECTIONS

5-45. AFTER HARD LANDING (CONT)

DATA REFERENCE	INSPECTION TASK DESCRIPTION	INITIAL MECH OTHER	
ASB 412-96-89	<div style="text-align: center; border: 1px dashed black; padding: 5px; width: fit-content; margin: 0 auto;"> CAUTION </div> <p>MAST ASSEMBLY 412-040-366-109 IS NOT FIELD SERVICEABLE. IT MUST BE RETURNED TO BHTI IF ANY INSPECTIONS REQUIRING DISASSEMBLY ARE REQUIRED.</p> <p style="text-align: center;">NOTE</p> <p>If there is any yielding or deformation in the main rotor attachment area or any other obvious damage, mast is unserviceable and nonrepairable.</p> <ul style="list-style-type: none"> (2) Transmission. (3) Main driveshaft. <p>b. Perform a thorough visual inspection of the following components that may be kept in service if no discrepancy or obvious damage is found. Replace any damaged component:</p> <ul style="list-style-type: none"> (1) Main rotor blades. (2) Main rotor hub. (3) Tail rotor blades. (4) Tail rotor hub. <p style="text-align: center;">NOTE</p> <p>Inspect tail rotor static stops for yielding as noted in Chapter 64 to determine if tail rotor yoke assembly may have been exposed to bending.</p> <ul style="list-style-type: none"> (5) Tail rotor static stop 212-011-713. (6) Tail rotor yoke 212-011-702. (7) Intermediate gearbox. (8) Tail rotor gearbox. 		



CONDITIONAL INSPECTIONS

5-45. AFTER HARD LANDING (CONT)

DATA REFERENCE	INSPECTION TASK DESCRIPTION	INITIAL	
		MECH	OTHER
	<p>(9) Tail rotor driveshafts.</p> <p>(10) Tail rotor driveshaft hangers.</p> <p>(11) Swashplate and support assembly.</p> <p>(12) Hub and sleeve assembly and collective lever.</p> <p>(13) Helicopter structure directly supporting damaged components identified in above inspections.</p> <p>c. Check all cowling and doors for proper fit and alignment. Remove cowling and inspect all attachment fittings.</p> <p style="text-align: center;">NOTE</p> <p>If significant damage has been found in any area of the airframe, expand inspection in those areas until no further damage is found.</p> <p>d. Using a 10X magnifying glass, make a complete inspection of pylon support structure for loose or sheared rivets, cracked brackets, buckled or cracked support angles, and webs. Pay particular attention to pylon mounts attaching points.</p> <p>e. Make a complete inspection of lift link, lift link attachment fittings, and lift beam for cracks and other evidence of damage. Remove lift link and replace with like serviceable item, if damaged.</p> <p>f. Remove both pylon dampers. Disassemble and check for internal yielding. Assemble and install if no evidence of damage. If any damage is found, replace with like serviceable item.</p> <p>g. Install serviceable mast, transmission assembly, and main driveshaft assembly. Install removed pylon control components.</p> <p>h. Check all engine mount fittings and bolts for damage and looseness.</p>		



CONDITIONAL INSPECTIONS

5-45. AFTER HARD LANDING (CONT)

DATA REFERENCE	INSPECTION TASK DESCRIPTION	INITIAL	
		MECH	OTHER
Chapter 53	<p>i. Inspect engine firewalls for evidence of warping, crushing, or other damage.</p> <p>j. Make a complete inspection of area where tailboom is attached to forward fuselage section. This includes both sets of attachment fittings and longerons, beam caps, skins, webs, bulkhead flanges, and other structural members. Check torque on attachment bolts to determine if yielding has occurred.</p>		
Chapter 67	<p>k. Completely inspect flight control system from pilot controls to rotor head for bent or damaged tubes, bellcranks, bellcrank supports, and for damaged control system bearings. Pay particular attention to pylon controls, lower cylinder attachment support fitting, and adjacent airframe structure.</p>		
Chapter 29	<p>l. Pressurize hydraulic system and check for leaks, interference, binding, and satisfactory operation.</p> <p>m. Inspect fuel, oil, and pneumatic system for damage. Perform engine ground run and visually check fuel, oil, and pneumatic lines for leaks.</p>		
Pratt & Whitney Canada Engine Maintenance Manual	<p>3. Inspect engine in accordance with applicable Pratt & Whitney Canada Engine Maintenance Manual.</p> <p>4. If no significant damage is found, further inspection is unnecessary.</p>		



CONDITIONAL INSPECTIONS

5-46. SUDDEN STOPPAGE — POWER ON OR OFF

DATA REFERENCE	INSPECTION TASK DESCRIPTION	INITIAL MECH OTHER	
	<p>DATE: _____ W.O. _____</p> <p>FACILITY: _____</p> <p>HELICOPTER S/N: _____</p> <p>REGISTRY NO.: _____</p> <p>TOTAL TIME: _____</p> <p>SIGNATURE: _____</p> <p style="text-align: center;">NOTE</p> <p>If the information contained in the following conditional inspection does not fully reflect the occurrence or if additional information or clarification is required, please contact Product Support Engineering for assistance.</p> <p style="text-align: center;">NOTE</p> <p>Sudden stoppage conditional inspection is to be accomplished after main or tail rotor blade strike or any drive system incident which inhibits free rotation of the drive system.</p> <p>Sudden stoppage is defined as any rapid deceleration of the drive system whether caused by seizure within the helicopter transmission or by contact of the main or tail rotor blades with the ground, water, snow, dense vegetation, or other object of sufficient inertia to cause rapid deceleration. Tail rotor blade damage, when caused by striking some object sufficiently to require blade replacement, is considered sudden stoppage.</p>		



CONDITIONAL INSPECTIONS

5-46. SUDDEN STOPPAGE — POWER ON OR OFF (CONT)

DATA REFERENCE	INSPECTION TASK DESCRIPTION	INITIAL	
		MECH	OTHER
	<p>If the sudden stoppage conditional inspection is the result of crash damage, all rotating system components shall be considered unserviceable and non-repairable. Crash damage is any damage sustained beyond the scope of that identified in conditional inspection (Paragraph 5-44).</p> <p>A blade strike is due to contact of main or tail rotor blades with the ground, water, snow, dense vegetation or other object sufficient to cause blade damage. However, not all blade strikes will meet the sudden stoppage definition.</p> <p>A blade strike which causes damage, dents or tear, to a main rotor or tail rotor blade skin behind the spar due to impact with a small foreign object (e.g. small stone or low mass item) that did not contact the leading edge and would not cause a sudden deceleration of the drive system is not considered a sudden stoppage, but may require the affected blade(s) to be repaired.</p> <p>A rotating system torque spike is defined as any other incident which causes a severe torque spike in the drive system. These incidents include, but are not limited to foreign object ingestion through the gear mesh in any gearbox.</p> <p style="text-align: center;">NOTE</p> <p>If overhaul evaluation is specified, complete both the conditional inspection and normal inspection procedures (as applicable) for that component listed in BHT-412-CR&O.</p> <p style="text-align: center;">NOTE</p> <p>Components removed from a helicopter for evaluation following a sudden stoppage shall be evaluated as an interrelated group. Removal records accompanying each component shall cross reference part and serial numbers of other drive system components removed for evaluation.</p>		



CONDITIONAL INSPECTIONS

5-46. SUDDEN STOPPAGE — POWER ON OR OFF (CONT)

DATA REFERENCE	INSPECTION TASK DESCRIPTION	INITIAL	
		MECH	OTHER
Chapter 62	<p>When any of these sudden stoppage incidents are reported, do the steps that follow:</p> <ol style="list-style-type: none"> 1. If the sudden stoppage was caused by a main rotor strike do the inspection that follows. <ol style="list-style-type: none"> a. Main Rotor Blades: <p style="text-align: center;">NOTE</p> <p>In all cases, ensure damage limits are adhered to.</p> <ol style="list-style-type: none"> (1) Visually inspect main rotor blades for damage such as cracks, bond voids and delamination. (2) If a blade is damaged sufficiently to require replacement, return it to an authorized repair facility. Make an entry in the component record to show reason for removal is a sudden stoppage. Refer to BHT-412-CR&O for repair limits. (3) Blades may remain in service if no damage was found or if damage was within acceptable damage limits. b. Main Rotor Hub and Pylon Controls. <ol style="list-style-type: none"> (1) If main rotor blades were not damaged sufficiently to require blade replacement, perform a visual inspection of the following components. If no evidence of damage is found, the inspected components may be retained in service. <ol style="list-style-type: none"> (a) Main rotor hub assembly. (b) Main rotor pitch links. (c) Main rotor swashplate and support. (d) Main rotor hub and sleeve. (e) Collective lever. (2) If the main rotor blade(s) were damaged as a result of a sudden stoppage the following shall be removed and an overhaul evaluation performed. 		



CONDITIONAL INSPECTIONS

5-46. SUDDEN STOPPAGE — POWER ON OR OFF (CONT)

DATA REFERENCE	INSPECTION TASK DESCRIPTION	INITIAL	
		MECH	OTHER
	<p>(a) Main rotor hub assembly.</p> <p>(b) Main rotor pitch links.</p> <p>(c) Main rotor swashplate and support.</p> <p>(d) Main rotor hub and sleeve.</p> <p>(e) Collective lever.</p> <p>Remove and discard all rotating control bolts. Make an entry in the component records to show reason for removal is a sudden stoppage.</p> <p>c. Main Rotor Driveshaft.</p> <p>(1) Remove and disassemble main driveshaft.</p> <p>(2) Visually inspect components for damage in accordance with BHT-412-CR&O. If no visual evidence of damage is detected, reassemble per BHT-412-CR&O.</p> <p>(3) If damage is detected, make an entry in the component records to show the reason for removal is a sudden stoppage.</p> <p>(4) Perform Main Driveshaft – Conditional inspection in accordance with BHT-412-CR&O.</p> <p>d. Transmission and mast assembly.</p> <p>(1) If a sudden stoppage incident was confirmed as a Result of impact damage to a main rotor blade leading edge exceeding limits specified in Chapter 62, remove the mast assembly and main rotor transmission assembly. Make an entry in the component records to show reason for removal is a sudden stoppage.</p> <p>(a) If the main rotor mast assembly is visibly bent, twisted or distorted, the mast assembly shall be scrapped and the main rotor transmission assembly and rotor brake quill assembly (if installed) shall have an overhaul evaluation performed. The lower planetary spider and lower mast bearing shall be scrapped.</p>		



CONDITIONAL INSPECTIONS

5-46. SUDDEN STOPPAGE — POWER ON OR OFF (CONT)

DATA REFERENCE	INSPECTION TASK DESCRIPTION	INITIAL MECH OTHER	
	<p>(b) If the main rotor mast assembly is not visibly bent, twisted or distorted then the main rotor mast, main rotor transmission assembly and rotor brake quill assembly (if installed) shall have an overhaul evaluation performed. Make an entry in the component records to show reason for removal is a sudden stoppage.</p> <p>(2) If a sudden stoppage incident was confirmed but the blade damage is confined to skin compression or wrinkling behind the spar, perform the following inspection:</p> <p>(a) Remove main rotor blades, main rotor hub, main rotor mast swashplate and support, hub and sleeve assembly from helicopter. Remove main rotor transmission if required.</p> <p>(b) Inspect mast assembly for distortion per BHT-412-CR&O. Provided the mast assembly does not exceed distortion limits, continue with step (c). If distortion exceeds limits, the mast assembly shall be considered scrap and transmission assembly shall have an overhaul evaluation performed. Make an entry in the component records to show the reason for removal is sudden stoppage.</p> <p>(c) Remove transmission top case, mast adapter, upper planetary assembly, upper sun gear, lower planetary assembly, and lower sun gear. Visually inspect all removed components as well as ring gear case for damage resulting from sudden stoppage. If damage is found the main rotor transmission and rotor brake quill (if installed) shall have an overhaul evaluation performed. Make an entry in component records to show reason for removal is a sudden stoppage.</p> <p>(d) If evaluation reveals no damage exceeding limits in BHT-412-CR&O manual, reassemble transmission and install main rotor mast, swashplate and support, hub and sleeve, main rotor hub and main rotor blades. Annotate component records as required.</p> <p>2. If the sudden stoppage was caused by a tail rotor strike do the inspection that follows.</p> <p>a. Tail Rotor Hub and Blade assembly.</p>		



CONDITIONAL INSPECTIONS

5-46. SUDDEN STOPPAGE — POWER ON OR OFF (CONT)

DATA REFERENCE	INSPECTION TASK DESCRIPTION	INITIAL	
		MECH	OTHER
	<p style="text-align: center;">NOTE</p> <p style="text-align: center;">In all cases ensure damage limits are adhered to.</p> <p>(1) Inspect tail rotor static stop for yielding as noted in Chapter 64 to determine if tail rotor yoke assembly may have been exposed to bending. Check for straightness across static stop P/N 212-011-713 outboard surface. If yielding has occurred, scrap the tail rotor yoke and static stop.</p> <p>(2) If a sudden stoppage incident was confirmed as a result of impact damage to the leading edge exceeding limits specified in chapter 64, the tail rotor hub and blade assembly shall be considered scrap and the following components shall be overhauled. Make an entry in the component records to show reason for removal is sudden stoppage.</p> <p style="padding-left: 40px;">(a) Tail rotor gearbox assembly.</p> <ul style="list-style-type: none"> • If during the overhaul; cracks, sheared or bend studs or evidence of case distortion are found the gearbox is unserviceable and nonrepairable and shall be scrapped. <p style="padding-left: 40px;">(b) Intermediate gearbox assembly.</p> <ul style="list-style-type: none"> • If during overhaul; cracks, case distortion or broken lugs are found, the gearbox is unserviceable and non-repairable and shall be scrapped. <p style="padding-left: 40px;">(c) Tail rotor driveshaft hanger assemblies.</p> <p style="padding-left: 40px;">(d) Tail rotor rotating controls.</p> <p>(3) If a sudden stoppage incident was confirmed but blade damage is confined to skin compression, wrinkling directly behind the spar, perform the following:</p> <p style="padding-left: 40px;">(a) Overhaul tail rotor hub assembly. Scrap or repair tail rotor blades.</p>		



CONDITIONAL INSPECTIONS

5-46. SUDDEN STOPPAGE — POWER ON OR OFF (CONT)

DATA REFERENCE	INSPECTION TASK DESCRIPTION	INITIAL MECH OTHER	
	<p>(b) Perform a close visual inspection of the tail rotor rotating controls. If no evidence of damage is found, the tail rotor rotating controls may remain in service. Replace all tail rotor rotating controls bolts. If damage to the tail rotor rotating controls is found, perform overhaul of the tail rotor rotating controls. Make an entry in the component record to show that reason for the removal is sudden stoppage.</p> <p>(c) Remove output shaft case (sleeve assembly) from tail rotor gearbox. Visually inspect input pinion and bevel gear for indication of sudden stoppage. Any indication or damage found will require overhaul of tail rotor gearbox. Make an entry in the component records to show reason for removal is a sudden stoppage.</p> <p>(d) Remove intermediate gearbox input and output quill. Visually inspect pinion for indication of a sudden stoppage. Any indication or damage found will require overhaul of the intermediate gearbox. Make an entry in the component records to show reason for removal is a sudden stoppage.</p> <p>(4) If the inspection is being conducted as a result of a tail rotor driveshaft, intermediate gearbox or tail rotor gearbox assembly induced torque spike, an overhaul evaluation of the tail rotor hub and blade assembly shall be performed. Make and entry in the component record to show reason for removal is a sudden stoppage.</p> <p>(5) If the inspection is being conducted as a result of the Main rotor strike or transmission induced torque spike, the tail rotor hub and blade assembly may remain in service provided there is no visible damage. If visible damage is noted on tail rotor hub and blade assembly, an overhaul evaluation of the tail rotor hub and blade assembly shall be performed. Make an entry in component record to show reason for removal is a sudden stoppage.</p> <p style="text-align: center;">NOTE</p> <p>If you replace driveshafts or hanger bearing assemblies because of the results in step (b) through (c), do a detailed visual inspection of the hanger bearing support structure for cracks, loose or sheared rivets and elongated holes.</p>		



CONDITIONAL INSPECTIONS

5-46. SUDDEN STOPPAGE — POWER ON OR OFF (CONT)

DATA REFERENCE	INSPECTION TASK DESCRIPTION	INITIAL MECH OTHER	
	<p>b. Tail rotor driveshaft hanger assemblies:</p> <p>(1) Remove hanger assemblies from helicopter and disassemble as required to allow visual inspection for indications of sudden stoppage. Any indication or damage found will require overhaul of the hanger assemblies. Make an entry in component records to show reason for removal is a sudden stoppage.</p> <p>(2) If tail rotor driveshaft has been damaged beyond the limits specified in Chapter 65 due to contact with main rotor blade or any other similar circumstances other than torsional overload, overhaul the hanger assembly that the driveshaft was attached to. If a tail rotor driveshaft is visibly twisted, all hanger assemblies and shafts shall be overhauled. Make an entry in the components records to show reason for removal is a sudden stoppage.</p> <p>(3) If any driveshafts fails because of torsional overload, remove and scrap all hanger assemblies and driveshaft.</p> <p>c. Tail rotor driveshafts:</p> <p>(1) Removal tail rotor driveshafts and inspect them for the following conditions. If one or more conditions listed in step (a) through step (d) below are noted, all hanger assemblies and driveshafts shall be overhauled. Make an entry in the component record to show that reason for the removal is sudden stoppage.</p> <p>(a) Inspect driveshaft curvic faces for distortion. (412 and 412SP only).</p> <p>(b) Inspect driveshaft for bends, twisting, out of roundness exceeding limits specified in Chapter 65.</p> <p>(c) Inspect driveshaft for cracks.</p> <p>(d) Inspect driveshaft for loose or shear rivets.</p>		



CONDITIONAL INSPECTIONS

5-46. SUDDEN STOPPAGE — POWER ON OR OFF (CONT)

DATA REFERENCE	INSPECTION TASK DESCRIPTION	INITIAL MECH OTHER	
	<p>(2) Disc pack couplings - Any deformation that results in gaps between laminates that are greater than 0.015 inch (0.38 mm), scrap the disk pack coupling. (Not applicable to 412 and 412SP).</p> <p>(3) Disc pack coupling bolts - Distortion or cracks in any bolt, scrap bolt. (Not applicable to 412 and 412SP).</p> <p>(4) Tail rotor drive adapters - Distortion beyond the limits specific in Chapter 65, scrap adapter.</p> <p>(5) If no damage that would render the tail rotor driveshaft unserviceable is noted, it may be returned to service.</p> <p>d. Inspect tail rotor drive system structural attachment as follows:</p> <p>(1) Inspect the tail rotor gearbox, intermediate gearbox attachment for cracks, sheared rivets or damage.</p> <p>(2) Inspect tail rotor driveshaft support structure for cracks, shear rivets or damage.</p> <p>e. Transmission sump assembly:</p> <p style="text-align: center;">NOTE</p> <p>If transmission assembly has already been removed for overhaul omit step e. If no evidence of damage was found in step b and step c above, omit step (1) through step (3) below.</p> <p>(1) If damage was found on driveshaft hanger assemblies, tail rotor driveshaft, intermediate gearbox assembly or tail rotor gearbox assembly, remove tail rotor output quill assembly from transmission sump assembly.</p> <p>(2) Inspect output quill pinion for unusual load patterns on both sides of teeth. Inspect sump case internally for gear contact damage. If no damage is found, install quill assembly. Transmission assembly may be retained in service.</p>		



CONDITIONAL INSPECTIONS

5-46. SUDDEN STOPPAGE — POWER ON OR OFF (CONT)

DATA REFERENCE	INSPECTION TASK DESCRIPTION	INITIAL	
		MECH	OTHER
	<p>(3) If inspection of the tail rotor output quill assembly reveals discrepancies, or gear contact with sump case is evident, remove transmission assembly and an overhaul evaluation of the sump case assembly shall be performed. Make an entry in component record to show reason for removal was blade strike or torque spike.</p> <p>3. Install or replace, as applicable, all removed components with like serviceable components.</p> <p>4. Refer to applicable Pratt & Whitney Canada Engine Maintenance Manual for sudden stoppage inspection requirements for the engine.</p>		



CONDITIONAL INSPECTIONS

5-47. AFTER OVERSPEED

DATA REFERENCE	INSPECTION TASK DESCRIPTION	INITIAL	
		MECH	OTHER
	<p>DATE: _____ W.O. _____</p> <p>FACILITY: _____</p> <p>HELICOPTER S/N: _____</p> <p>REGISTRY NO.: _____</p> <p>TOTAL TIME: _____</p> <p>SIGNATURE: _____</p> <p style="text-align: center;">NOTE</p> <p>Accomplish after overspeed.</p> <p>Components removed from a helicopter for evaluation following an overspeed shall be evaluated as an interrelated group. Removal records accompanying each component shall cross reference part and serial numbers of other drive system components removed for evaluation.</p> <p><u>AFTER OVERSPEED</u></p> <p>Overspeed is defined as any incident in which 110% main rotor rpm is exceeded and/or engine overspeed limits in engine manual are exceeded.</p> <p>1. Perform overspeed inspection as follows:</p> <p style="padding-left: 20px;">a. Main rotor hub assembly:</p> <p style="padding-left: 40px;">(1) Remove main rotor hub. Remove main rotor blades.</p> <p style="padding-left: 40px;">(2) Perform an overhaul conditional evaluation inspection. Make an entry in component record to show reason for removal was overspeed.</p> <p style="padding-left: 40px;">(3) Inspect main rotor blade retention bolts.</p>		
Chapter 62			
BHT-412-CR&O			
BHT-412-CR&O			



CONDITIONAL INSPECTIONS

5-47. AFTER OVERSPEED (CONT)

DATA REFERENCE	INSPECTION TASK DESCRIPTION	INITIAL	
		MECH	OTHER
Chapter 64	<p>b. Main rotor blades:</p> <p>(1) Inspect main rotor blades skin for wrinkles and deformation.</p> <p>(2) If no discrepancies are found, main rotor blades may be retained in service.</p> <p>(3) If discrepancies are found, return all blades to an authorized blade repair station. Make an entry in component record to show reason for removal was overspeed. If known, list percent of overspeed and duration.</p> <p>c. Tail rotor hub and blades:</p> <p>(1) Remove tail rotor hub and blade assembly.</p> <p>(2) Remove tail rotor blades.</p> <p>(3) Replace tail rotor blade retention bolts.</p> <p>d. Tail rotor blades:</p> <p>(1) Perform Major Overspeed Inspection of tail rotor blades.</p> <p>(2) Make an entry in component record to show reason for removal was overspeed.</p> <p>e. Perform a close inspection of the following components. If no visual damage is found, components may be retained in service.</p> <p>(1) Main transmission.</p> <p>(2) Intermediate gearbox. Check gearbox for security and retorque retaining bolts.</p> <p>(3) Tail rotor gearbox. Check gearbox for security and retorque retaining nuts.</p> <p>(4) Main rotor mast.</p> <p>(5) Main input driveshaft.</p>		
BHT-412-CR&O			



CONDITIONAL INSPECTIONS

5-47. AFTER OVERSPEED (CONT)

DATA REFERENCE	INSPECTION TASK DESCRIPTION	INITIAL MECH OTHER	
Pratt & Whitney Canada Engine Maintenance Manual	<p>(6) Tail rotor driveshafts.</p> <p>(7) Tail rotor driveshafts hangers.</p> <p>(8) Swashplate.</p> <p>(9) Drive hub and sleeve.</p> <p>(10) Tail rotor hub.</p> <p>f. Install a serviceable main rotor hub and blade assembly. Install serviceable tail rotor blades. Balance and install tail rotor hub and blade assembly.</p> <p>g. Refer to applicable Pratt & Whitney Canada Engine Maintenance Manual for engine overspeed and inspection requirements.</p>		



CONDITIONAL INSPECTIONS

5-48. AFTER OVERTORQUE

DATA REFERENCE	INSPECTION TASK DESCRIPTION	INITIAL	
		MECH	OTHER
Pratt & Whitney Canada Engine Maintenance Manuals	DATE: _____ W.O. _____ FACILITY: _____ HELICOPTER S/N: _____ REGISTRY NO.: _____ TOTAL TIME: _____ SIGNATURE: _____		
	<p style="text-align: center;">NOTE</p> <p>Accomplish after overtorque.</p> <p>Components removed from a helicopter for evaluation following an overtorque shall be evaluated as an interrelated group. Make entries in component records to cross reference part and serial numbers of other drive system components removed for evaluation.</p> <p><u>AFTER OVERTORQUE</u></p> <p>Overtorque is defined as any incident in which torsional loads are introduced into the helicopter dynamic system in excess of established limits.</p> <p>1. Refer to applicable Pratt & Whitney Canada Engine Maintenance Manual for engine overtorque inspection limits.</p> <p style="text-align: center;">NOTE</p> <p>To assist with determining engine overtorque inspection requirements, the following table provides a comparison between Bell Helicopter cockpit torque gauge % values and Pratt & Whitney Maintenance Manual FT LB values.</p>		



CONDITIONAL INSPECTIONS

5-48. AFTER OVERTORQUE (CONT)

DATA REFERENCE	INSPECTION TASK DESCRIPTION						INITIAL	
							MECH	OTHER
	PT6T-3B/ -3BF ^{△1}		PT6T-3B/-3BE/ -3BF/-3BG ^{△2}		PT6T-3D/-3DE/ -3DF ^{△3}		PT6T-9 ^{△4}	
	BELL % TQ	P&WC FT LB	BELL % TQ	P&WC FT LB	BELL % TQ	P&WC FT LB		
	85.3	915	82.1	915	98.7	1100		
	81.6	875	78.5	875	96.5	1075		
	76	815	73.2	815	94.2	1050		
	66.8	738	66.2	738	89.8	1000		
					85.3	950		
					81.0	902		
					77.1	859		
					76.3	850		
					73.2	815		
					71.8	800		
					67.3	750		
<p>NOTES:</p> <p>^{△1} 412 S/N 33001 through 33107 Pre TB 412-84-44.</p> <p>^{△2} 412 S/N 33001 through 33107 Post TB 412-84-44 and all 412SP S/N 33108 through 33213, 36001 through 36019, and 412HP S/N 36020 through 36086 with PT6T-3B series engines installed.</p> <p>^{△3} 412SP S/N 33108 through 33213, 36001 through 36019, and 412HP S/N 36020 through 36086 with PT6T-3D series engines installed and 412EP S/N 36087 through 36999.</p> <p>^{△4} For 412EPI S/N 37002 through 37999, refer to PT6T-9 engine maintenance manual.</p>								



CONDITIONAL INSPECTIONS

5-48. AFTER OVERTORQUE (CONT)

DATA REFERENCE	INSPECTION TASK DESCRIPTION	INITIAL	
		MECH	OTHER
	<p>2. When torque has exceeded 100% for 3 seconds or less, but has not exceeded 104% (105% mast torque for helicopters modified by 412-570-001-103 and S/N 36020 through 36999 and 37002 through 37999), with transmission lower spider 204-040-785-003 or 412-040-785-103 installed, then no further maintenance is required.</p> <p style="text-align: center;">NOTE</p> <p>If transmission lower spider 412-040-785-101 is installed, when torque has exceeded 100%, but has not exceeded 104% (105% mast torque for helicopters modified by 412-570-001-103, and S/N 36020 through 36058), perform a thorough visual inspection of the components listed in the following step. If inspection does not reveal any discrepancies or obvious damage, components may be retained in service.</p> <p>3. When torque has exceeded 100% for more than 3 seconds, but has not exceeded 104% (105% mast torque for helicopters modified by 412-570-001-103 and S/N 36020 through 36999 and 37002 through 37999), perform a thorough visual inspection of the following components. If inspection does not reveal any discrepancies or obvious damage, components may be retained in service.</p> <ul style="list-style-type: none"> a. Tail rotor blades. b. Main rotor hub. c. Tail rotor hub. d. Intermediate gearbox. Check gearbox for security and torque check retaining bolts. e. Tail rotor gearbox. Check gearbox for security and torque check retaining nuts. f. Tail rotor driveshafts. g. Tail rotor driveshaft hangers. h. Swashplate. 		



CONDITIONAL INSPECTIONS

5-48. AFTER OVERTORQUE (CONT)

DATA REFERENCE	INSPECTION TASK DESCRIPTION	INITIAL	
		MECH	OTHER
	<ul style="list-style-type: none"> i. Hub and sleeve assembly. j. Main driveshaft. k. Mast. l. Transmission. <p>4. When overtorque exceeds 104%, but does not exceed 112% (105 and 110% mast torque respectively for helicopters S/ N 36020 through 36999 and 37002 through 37999, and helicopters modified by 412-570-001-103 or Post BHT-412-SI-74 (412SP to 412HP Upgrade), do as follows:</p> <ul style="list-style-type: none"> a. Perform thorough visual inspection of components listed in step 3. b. Inspect main transmission chip detector(s). c. Inspect main transmission internal filter or full flow debris monitor (as applicable). <p>(1) If metal particles are found, indicating internal failure, remove transmission for overhaul evaluation. Make an entry in the component record explaining reason for removal was overtorque. Remove all transmission system oil lines. Flush and reinstall oil lines. Replace external oil filter element. Remove and scrap oil cooler. Install new oil cooler.</p> <p>(2) If chip detector(s) and internal filter or full flow debris monitor (as applicable) appear normal and there is no evidence of internal failure, return helicopter to service. Operate normally for 3 to 10 hours and then check chip detector(s) and internal filter or full flow debris monitor (as applicable). If no metal particles are found, indicating internal failure, normal scheduled inspection intervals may then be followed. If metal particles are present prior to or at the 3 to 10-hour check or if there is any evidence of internal failure, remove transmission for overhaul evaluation. Make an entry in the component record explaining reason for removal was overtorque. Remove all transmission system oil lines. Flush and reinstall oil lines. Replace external oil filter element. Remove and scrap oil cooler. Install new oil cooler.</p>		



CONDITIONAL INSPECTIONS

5-48. AFTER OVERTORQUE (CONT)

DATA REFERENCE	INSPECTION TASK DESCRIPTION	INITIAL MECH OTHER	
	<p>5. When overtorque has exceeded 112% (110% mast torque for helicopters S/N 36020 through 36999 and 37002 through 37999, and helicopters modified by 412-570-001-103 or Post BHT-412-SI-74 (412SP to 412HP Upgrade):</p> <p>a. Return the following components to an overhaul facility for overhaul evaluation.</p> <p style="text-align: center;">NOTE</p> <p>Component removal record of dynamic components shall reflect overtorque as reason for removal.</p> <ul style="list-style-type: none"> (1) Transmission. (2) Main driveshaft. (3) Main rotor hub. (4) Mast. <p>b. Perform thorough visual inspection of other components outlined in step 3.</p>		



CONDITIONAL INSPECTIONS

5-49. AFTER COMPRESSOR STALL OR SURGE

DATA REFERENCE	INSPECTION TASK DESCRIPTION	INITIAL	
		MECH	OTHER
	<p>DATE: _____ W.O. _____</p> <p>FACILITY: _____</p> <p>HELICOPTER S/N: _____</p> <p>REGISTRY NO.: _____</p> <p>TOTAL TIME: _____</p> <p>SIGNATURE: _____</p> <p style="text-align: center;">NOTE</p> <p>Accomplish after engine compressor stall or surge.</p> <p>Discuss circumstances of reported compressor stall with pilot. Determine N₁ speed at which reported stall occurred. Check helicopter and engine logs for any pertinent history.</p> <p><u>AFTER ENGINE COMPRESSOR STALL OR SURGE</u></p> <p>Engine compressor stall or surge is characterized by a sharp rumble or a series of loud sharp reports, severe engine vibration, and a rapid rise in Inter-Turbine Temperature (ITT), depending on severity of surge. When a surge has been reported, progressively perform step 1 through step 3, as dictated by discrepant conditions.</p> <p>Components removed from a helicopter for evaluation following a compressor stall or surge shall be evaluated as an interrelated group. Removal records accompanying each component shall cross reference part and serial numbers of other drive system components removed for evaluation.</p> <p style="text-align: center;">NOTE</p> <p>If overhaul evaluation is specified, complete both the conditional inspection and normal inspection procedures (as applicable) for that component listed in BHT-412-CR&O.</p>		



CONDITIONAL INSPECTIONS

5-49. AFTER COMPRESSOR STALL OR SURGE (CONT)

DATA REFERENCE	INSPECTION TASK DESCRIPTION	INITIAL MECH OTHER	
	<p>e. Remove and inspect tail rotor driveshafts.</p> <p>f. Remove input and output drive quill from intermediate gearbox and inspect gear teeth on pinion and gear for damage with a 10X magnifying glass. If no evidence of scoring or scuffing is found and there is no mechanical damage that would render gearbox unserviceable, reassemble and perform step 3. If gear teeth are scuffed or scored or gearbox has sustained other damage, gearbox shall be removed and an overhaul evaluation performed (Make an entry in the component record to show the reason for removal was compressor stall or surge) and step g and step h shall be accomplished.</p> <p>g. Remove tail rotor gearbox from helicopter and remove input quill. Inspect gear teeth on pinion and gear for damage with a 10X magnifying glass. If no evidence of scoring or scuffing is found and there is no other damage that would render gearbox unserviceable, it may be reassembled and reinstalled for continued use. If gear teeth are scored or scuffed or there is other damage that would render gearbox unserviceable, gearbox shall be removed and an overhaul evaluation performed. Make an entry in the component record to show the reason for removal was compressor stall or surge.</p> <p>h. Remove tail rotor drive quill from transmission and inspect gear teeth for damage with a 10X magnifying glass. If there is no indication of scoring or scuffing and there is no other damage that would render transmission unserviceable, it is suitable for continued use. If gear teeth are scored or scuffed or there is other damage that would render the transmission unserviceable gearbox shall be removed and an overhaul evaluation performed. Make an entry in the component record to show the reason for removal was compressor stall or surge. Comply with step i.</p> <p>i. If the transmission is sent for an overhaul evaluation, the procedures outlined in step 1 through step 9 shall be performed.</p>		



CONDITIONAL INSPECTIONS

5-49. AFTER COMPRESSOR STALL OR SURGE (CONT)

DATA REFERENCE	INSPECTION TASK DESCRIPTION	INITIAL	
		MECH	OTHER
	<p>(1) Remove tail rotor driveshafts and inspect for the following conditions. Replace any tail rotor driveshafts exceeding limits specified in Chapter 65. If one or more of conditions listed in step a through step d are noted, all hanger assemblies shall be sent for overhaul evaluation. Note on removal tag that reason for removal was compressor stall or surge.</p> <p style="padding-left: 40px;">(a) Curvic faces distorted (412 and 412SP only).</p> <p style="padding-left: 40px;">(b) Tube bent, twisted, or out of roundness.</p> <p style="padding-left: 40px;">(c) Cracks.</p> <p style="padding-left: 40px;">(d) Loose or sheared rivets.</p> <p>(2) Disc pack couplings (412HP and 412EP/412EPI/412EPX only) - Any deformation of disc pack that results in gaps between laminates that are greater than 0.015 inch (0.38 mm) will require replacement. Not applicable to 412 and 412SP.</p> <p>(3) Disc pack coupling bolts - Distortion or cracks in any bolt will require replacement. Not applicable to 412 and 412SP.</p> <p>(4) Tail rotor drive adapters - Distortion beyond the limits specified in Chapter 65 will require replacement.</p> <p>(5) Tail rotor hub and blade assembly - perform an overhaul evaluation. Make an entry in component record showing reason for removal was compressor stall.</p> <p>(6) Remove main rotor blades retention bolts. Check 412-010-124 type bolts for deformation and perform magnetic particle inspection on bolts. Inspect 412-010-137-103 expandable bolts for damage. If satisfactory, return to service.</p> <p>(7) Remove main rotor damper bridge assemblies and check for deformation of bushings and bushing holes.</p> <p>(8) Perform close visual inspection of all other main rotor components.</p>		



CONDITIONAL INSPECTIONS

5-49. AFTER COMPRESSOR STALL OR SURGE (CONT)

DATA REFERENCE	INSPECTION TASK DESCRIPTION	INITIAL MECH OTHER	
	<p>(9) If any discrepancies are noted as a result of inspection in step 6 through step 8, remove main rotor hub assembly, main rotor blades and mast assembly. Removed assemblies shall have an overhaul evaluation performed. Make an entry in component records showing reason for removal was compressor stall.</p> <p>3. Airframe:</p> <p>a. Check tailboom fin for evidence of damaged skin panels and/or structure and rivets for looseness and/or sheared heads. If inspection shows no indications of damage, return helicopter to flight status. If positive evidence of damage is found, comply with following step b through step e.</p> <p>b. Remove skin from tailboom fin adjacent to tail rotor gearbox mounting. Inspect all support structures in this area and repair as required. Install new skin.</p> <p>c. Make close visual inspection of complete tailboom structure for distortion, buckles, skin cracks, and sheared or loose rivets. Pay particular attention to tailboom attachment points at FS 241.43 to 243.9, adjacent fuselage to tailboom intermediate gearbox support structure.</p> <p>d. Make close visual inspection of main pylon support and engine mount attachment structure for distortion, buckles, cracks, sheared, or loose rivets, etc.</p> <p>e. If discrepancies found during inspection in step b through step d cannot be repaired by standard procedures, replace discrepant assembly.</p> <p>4. Install serviceable components.</p>		



CONDITIONAL INSPECTIONS

5-50. AFTER LIGHTNING STRIKES

DATA REFERENCE	INSPECTION TASK DESCRIPTION	INITIAL MECH OTHER	
	<p>DATE: _____ W.O. _____</p> <p>FACILITY: _____</p> <p>HELICOPTER S/N: _____</p> <p>REGISTRY NO.: _____</p> <p>TOTAL TIME: _____</p> <p>SIGNATURE: _____</p> <p style="text-align: center;">NOTE</p> <p>Accomplish after lightning strikes.</p> <p>In all instances below, if significant damage has been found in any area, inspection shall be expanded in those areas until it extends beyond the zone of damage. Any damage found anywhere on helicopter shall be recorded in detail and copies of these records shall be provided along with any component returned for overhaul to assist overhauling facility in evaluating component.</p> <p><u>AFTER LIGHTNING STRIKES</u></p> <p>When helicopter is suspected of receiving a lightning strike, accomplish the following:</p> <ol style="list-style-type: none"> 1. Visually inspect all external surfaces of helicopter with particular attention to main rotor hub and blades, transmission and mast assembly, tail rotor blades and hub, tail rotor gearbox, and vertical fin. Check electrical instruments and systems. Verify magnetic compass accuracy. 2. If visual indications of damage are present, proceed as follows: 		



CONDITIONAL INSPECTIONS

5-50. AFTER LIGHTNING STRIKES (CONT)

DATA REFERENCE	INSPECTION TASK DESCRIPTION	INITIAL	
		MECH	OTHER
BHT-412-CR&O	<p>a. Remove and visually inspect main rotor blades. If blades show any of the following indications, send the blades to a Bell Helicopter Textron approved blade repair facility for evaluation. State lightning strike as reason for removal.</p> <p>(1) Inspect blades for signs of burns. Burn marks can be very minute.</p> <p>(2) Inspect blades for debond in all bonded areas.</p> <p>b. Remove main rotor hub for overhaul. State lightning strike reason for removal. Inspect main rotor hub and rotating controls for indication of arcing or burning.</p> <p>c. Remove main driveshaft for inspection.</p>		
BHT-412-CR&O	<p>(1) Disassemble to extent required for cleaning and repacking coupling.</p> <p>(2) Clean coupling.</p> <p>(3) Visually inspect couplings for any evidence of arc burning or pitting. Pay special attention to tips, roots, and profiles of male and female coupling teeth. Any evidence of arc burning or pitting is cause for rejection.</p> <p>(4) Repack coupling.</p> <p>d. Remove tail rotor output coupling for inspection.</p>		
BHT-412-CR&O	<p>(1) Disassemble to extent required for cleaning and repacking coupling.</p> <p>(2) Clean coupling.</p> <p>(3) Visually inspect couplings for any evidence of arc burning or pitting. Pay special attention to tips, roots, and profiles of male and female coupling teeth. Any evidence of arc burning or pitting is cause for rejection.</p> <p>(4) Repack coupling.</p>		



CONDITIONAL INSPECTIONS

5-50. AFTER LIGHTNING STRIKES (CONT)

DATA REFERENCE	INSPECTION TASK DESCRIPTION	INITIAL	
		MECH	OTHER
Chapter 63	<p>e. If main rotor blades, main rotor hub, main driveshafts, or tail rotor output coupling exhibit evidence of damage that can be attributed to a lightning strike, remove transmission and mast assembly for overhaul. State lightning strike as reason for removal. If no evidence of damage is noted on the above mentioned components, inspect main transmission as follows:</p> <p>(1) Remove and inspect all transmission chip detectors.</p> <p>(2) If any evidence of arc burning or pitting is noted or excessive debris is found on chip detectors, remove transmission and mast assembly for overhaul. State lightning strike as reason for removal.</p> <p>(3) If no evidence of arc burning or pitting is noted, ground run light on skids for 1 hour. Reinspect chip detectors and remove and inspect oil filter. Repeat these inspections after accumulating 5 flight hours but prior to 10 flight hours.</p>		
Chapter 64	<p>f. Inspect tail rotor blades and hub. If indications of burns or debonding are present, send the blades to a Bell Helicopter Textron approved blade repair facility for evaluation. State lightning strike as reason for removal. Remove tail rotor hub for overhaul.</p>		
Chapter 65	<p>g. Remove and inspect tail rotor gearbox and intermediate gearbox chip detectors.</p> <p>h. If tail rotor blades, tail rotor hub, or tail rotor output coupling exhibit evidence of damage that can be attributed to a lightning strike or excessive debris is found on chip detectors, remove tail rotor gearbox, intermediate gearbox, and tail rotor driveshaft hangers for overhaul. State lightning strike as reason for removal. Additionally, tail rotor driveshaft tubes, disc pack couplings, and attaching hardware shall be visually inspected for evidence of arc burns or pitting. Any evidence of arc burning or pitting is cause for rejection.</p> <p>i. If no evidence of arc burning or pitting is noted, ground run light on skids for one hour. Reinspect chip detector. Repeat this inspection after accumulating 5 flight hours but prior to 10 flight hours.</p>		



CONDITIONAL INSPECTIONS

5-50. AFTER LIGHTNING STRIKES (CONT)

DATA REFERENCE	INSPECTION TASK DESCRIPTION	INITIAL	
		MECH	OTHER
Chapter 63 BHT-412-CR&O	<p>3. If no visual indications of damage are present, proceed as follows:</p> <p style="padding-left: 40px;">a. Remove and inspect all transmission chip detectors.</p> <p style="padding-left: 80px;">(1) If excessive debris is found on chip detectors, remove transmission and mast assembly for overhaul.</p> <p style="padding-left: 80px;">(2) If little or no debris is found, ground run light on skids for one hour. Reinspect chip detectors.</p> <p style="padding-left: 40px;">b. Remove and inspect oil filter.</p> <p style="padding-left: 40px;">c. Repeat these inspections after accumulating 5 flight hours but prior to 10 flight hours.</p> <p>4. Prior to first flight after a suspected or confirmed lightning strike, verify proper function of all drive system component chip detectors as follows:</p> <p style="padding-left: 40px;">a. Remove electrical connector from chip detector.</p> <p style="padding-left: 40px;">b. Remove chip detector and reinstall connector.</p> <p style="padding-left: 40px;">c. With electrical power applied to helicopter systems, bridge chip detector gap with a clean screwdriver or other clean conductive object.</p> <p style="padding-left: 40px;">d. Verify proper indication on caution panel. Verify illumination of MASTER CAUTION light.</p> <p style="padding-left: 40px;">e. Perform repairs as required.</p> <p>5. When it has been established lightning has struck helicopter, inspections of electrical and instrument systems that follow are mandatory to ensure safety of flight:</p> <p style="padding-left: 40px;">a. Inspect all electrical wiring, bundles, and connectors for burning or electrical arcing. Unplug all connectors and inspect pins and housing for electrical arcing or burning. Inspect interior of all circuit breaker panels for burning or electrical arcing. Replace any wires, connectors, or circuit breakers found to be damaged.</p>		



CONDITIONAL INSPECTIONS

5-50. AFTER LIGHTNING STRIKES (CONT)

DATA REFERENCE	INSPECTION TASK DESCRIPTION	INITIAL MECH OTHER	
Chapter 96	<p>b. Inspect main rotor blades and control links, transmission system, driveshafts, gearboxes, and tailboom structure for magnetization. Using a magnetometer with a range no larger than ± 5 gauss, place arrow or red dot (depending on magnetometer model) within 0.5 inch (13 mm) of item being checked with arrow pointing directly at item. If components of any item have a reading greater than one gauss, those items shall be degaussed.</p> <p style="text-align: center;">NOTE</p> <p>Do not test chip detectors for magnetization. If transmission or gearbox magnetic readings are greater than one gauss near chip detector, remove chip detector from housing and repeat test.</p> <p>c. Remove and bench test DC control units. Operationally check starter generators and inverters for proper operation. Visually inspect starter generators and inverters for burns or electrical arcing. If damaged, remove for internal inspection and bench test.</p> <p>d. Perform operational check of bussing system as dictated in the BHT-412-MM.</p> <p>e. Inspect transmission and tail rotor gearbox chip detectors for proper operation. Remove chip detectors found inoperative.</p> <p>f. Perform operational check of interior and exterior lighting system. Replace lamps, bulbs, and lighting assemblies as required.</p> <p>g. Perform operational check on all instruments. Remove and repair/replace instruments and sensors found to be defective.</p> <p>h. Perform operational check on all caution messages for proper operation.</p>		



CONDITIONAL INSPECTIONS

5-50. AFTER LIGHTNING STRIKES (CONT)

DATA REFERENCE	INSPECTION TASK DESCRIPTION	INITIAL	
		MECH	OTHER
Chapter 32	<p>6. When it has been established lightning has struck helicopter, the structural inspections that follow are mandatory to ensure safety of flight:</p> <p style="text-align: center;">NOTE</p> <p style="text-align: center;">Arcing damage on metal components of airframe structure, when cleaned out to twice visible depth, shall be treated as mechanical damage, and damage limits in the BHT-412-MM establish repairability and/or scrap of component. Any other structural damage (tears, voids, rupture, etc., directly or indirectly related to lightning strike) shall also be treated as mechanical damage.</p> <p style="padding-left: 20px;">a. Check honeycomb sandwich panels in suspect areas for voids or debond. If damage is apparent, proceed with normal maintenance procedures.</p> <p style="padding-left: 20px;">b. Check fixed controls and support system components for possible arcing damage. Bearings in rod ends, bellcranks, and supports are most susceptible to arcing damage; check bearings for smooth rotation. Visibly inspect attaching hardware of support for signs of lightning damage (damaged finish and/or burns). If damage is evident, remove supports and inspect mounting holes and mating surfaces for arcing damage. Arcing damage shall be blended out to twice its visible depth. Repaired damages shall not exceed mechanical damage limits.</p> <p style="padding-left: 20px;">c. When it is apparent lightning has been grounded through skid landing gear, remove entire landing gear assembly and inspect crosstubes and airframe support fittings for possible arcing damage; specifically, inspect attaching holes and mating surfaces of crosstubes directly beneath landing gear bearing/retaining supports. Clean out arcing damage to twice visible depth. Damage, after cleanup, shall not exceed allowable mechanical damage limits.</p> <p style="padding-left: 20px;">d. Any airframe metal parts not specifically identified above but are suspect, shall be noted in maintenance log and shall be reinspected prior to next 100 hours of flight.</p>		



CONDITIONAL INSPECTIONS

5-51. AFTER ENGINE COMBINING GEARBOX CLUTCH NON-ENGAGEMENT, MISENGAGEMENT, OR IN-FLIGHT SLIPPAGE

DATA REFERENCE	INSPECTION TASK DESCRIPTION	INITIAL	
		MECH	OTHER
Pratt & Whitney Canada Engine Maintenance Manual	<p>DATE: _____ W.O. _____</p> <p>FACILITY: _____</p> <p>HELICOPTER S/N: _____</p> <p>REGISTRY NO.: _____</p> <p>TOTAL TIME: _____</p> <p>SIGNATURE: _____</p> <p style="text-align: center;">NOTE</p> <p>Accomplish after engine combining gearbox clutch nonengagement, misengagement, or in-flight slippage.</p> <p>A nonengaged engine is indicated by near zero torque, higher N₂, and much cooler ITT as compared to engaged engine.</p> <p><u>AFTER ENGINE COMBINING GEARBOX CLUTCH NONENGAGEMENT, MISENGAGEMENT, OR IN-FLIGHT SLIPPAGE</u></p> <p>1. Non-engagement — perform inspection in accordance with applicable Pratt & Whitney Canada Engine Maintenance Manual.</p> <p>2. Misengagement.</p> <p style="text-align: center;">NOTE</p> <p>If a sprag clutch has failed to engage, and/or subsequently engages with or without audible or physical (helicopter jolt) indications, proceed as follows:</p>		



CONDITIONAL INSPECTIONS

5-51. AFTER ENGINE COMBINING GEARBOX CLUTCH NON-ENGAGEMENT, MISENGAGEMENT, OR IN-FLIGHT SLIPPAGE (CONT)

DATA REFERENCE	INSPECTION TASK DESCRIPTION	INITIAL	
		MECH	OTHER
Pratt & Whitney Canada Engine Maintenance Manual	<p>a. Combining gearbox shall be removed and returned to Pratt & Whitney Canada for investigation.</p>		
BHT-412-CR&O	<p>b. Inspect transmission spiral bevel gear as follows:</p> <p>(1) Gain access to left side of transmission and, if installed, remove rotor brake and quill assembly or rotor brake quill port cover.</p> <p>(2) Utilizing rotor brake quill port opening, inspect all sixty two teeth of main spiral bevel gear convex side for unsatisfactory conditions such as scoring, hard lines, nicks, dents, chipping, metal deformation, etc. Inspect all 62 teeth on spiral bevel gear concave side (Figure 5-11).</p> <p style="text-align: center;">NOTE</p> <p>Inspection mirrors and a suitable light are required. The rotor must be turned slowly to permit inspection of all gear teeth.</p>		
BHT-412-CR&O	<p>(3) Remove and replace any gear not meeting inspection requirements set forth in step (2). Overhaul rotor brake quill.</p> <p style="text-align: center;">NOTE</p> <p>Components removed from a helicopter for evaluation following combining gearbox clutch nonengagement, misengagement, or in-flight slippage shall be evaluated as an interrelated group. Removal records accompanying each component shall cross reference part and serial numbers of other drive system components removed for evaluation.</p> <p>(4) Install rotor brake and quill.</p> <p>(5) Install cowling and inspection panels.</p>		



CONDITIONAL INSPECTIONS

5-51. AFTER ENGINE COMBINING GEARBOX CLUTCH NON-ENGAGEMENT, MISENGAGEMENT, OR IN-FLIGHT SLIPPAGE (CONT)

DATA REFERENCE	INSPECTION TASK DESCRIPTION	INITIAL	
		MECH	OTHER
BHT-412-CR&O	<p>(6) Perform a 15 minute ground run to determine if any oil leaks are present at rotor brake quill (or quill port cover) assembly.</p> <p>c. Perform inspection in accordance with compressor stall or surge inspection, except inspect drive train as follows:</p> <p>(1) Visually inspect main rotor mast and controls for damage. If signs of yielding are evident, transmission and mast assembly and any other damaged components shall be replaced.</p> <p>(2) Visually inspect tail rotor driveshaft for damage.</p> <p>(3) Remove output quill from tail rotor gearbox and inspect both sides of gear teeth for scoring, scuffing, or other damage or marks indicating excessive load.</p> <p style="text-align: center;">NOTE</p> <p>If a tail rotor driveshaft has failed or yielded, all tail rotor driveshafts, hanger assemblies, intermediate gearbox, and tail rotor gearbox shall be replaced and tail rotor drive quill in transmission shall be removed and inspected for damage in accordance with compressor stall inspection. If scoring, scuffing, or other damage or marks indicating excessive load are found in intermediate gearbox or tail rotor gearbox, but tail rotor driveshafts are serviceable, gearbox(es) that are not serviceable shall be replaced.</p> <p>3. In-flight clutch slippage.</p>		



CONDITIONAL INSPECTIONS

5-51. AFTER ENGINE COMBINING GEARBOX CLUTCH NON-ENGAGEMENT, MISENGAGEMENT, OR IN-FLIGHT SLIPPAGE (CONT)

DATA REFERENCE	INSPECTION TASK DESCRIPTION	INITIAL MECH OTHER	
Pratt & Whitney Canada Engine Maintenance Manual	<p style="text-align: center;">NOTE</p> <p>If clutch slippage occurs, proceed as follows:</p> <p>a. Combining gearbox shall be removed and returned to Pratt & Whitney Canada for investigation.</p> <p>b. Inspect spiral bevel gear in accordance with step (2) of step 2b. If spiral bevel gear is damaged, perform misengagement inspection given in step (c) of step 2.</p>		

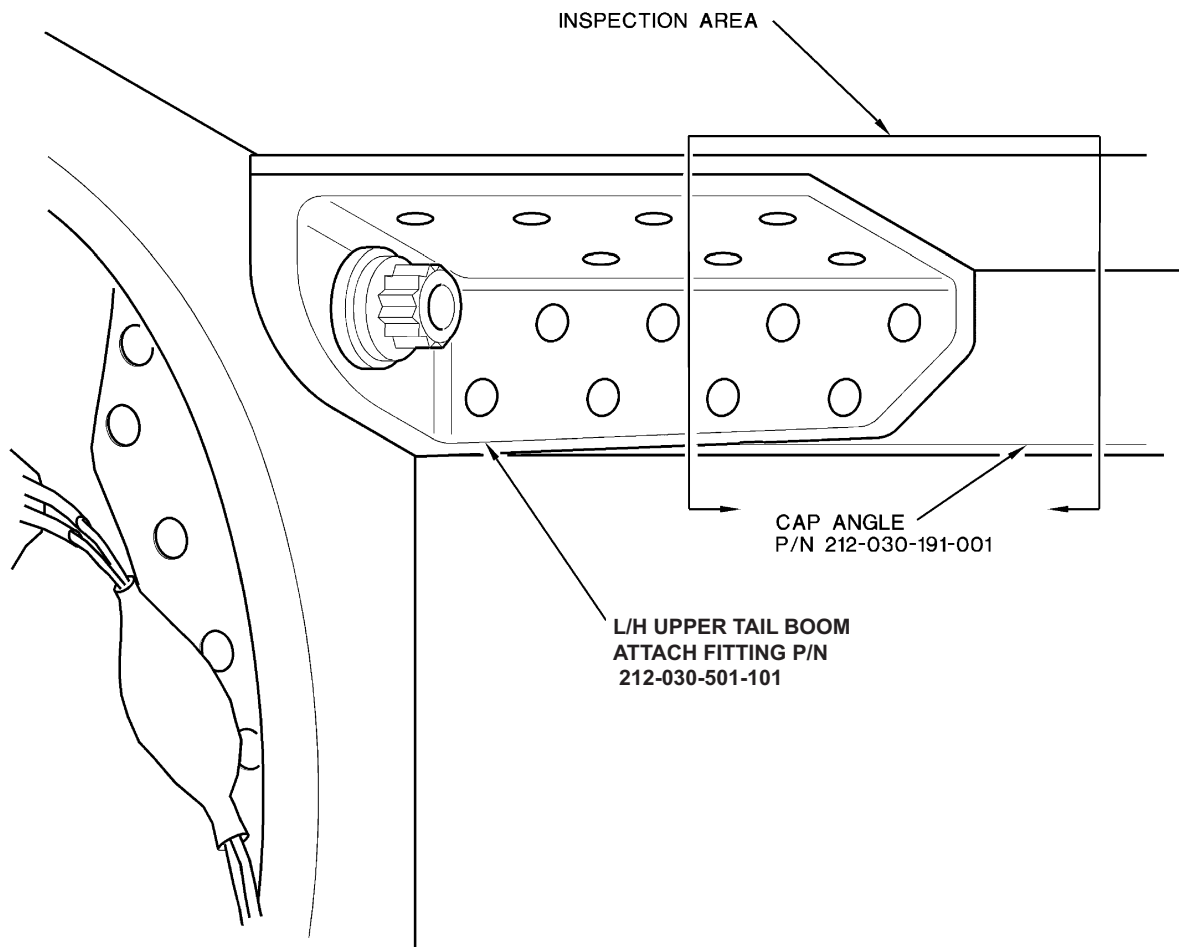

412_MM_05_0001_c01

Figure 5-10. Fuselage Tailboom Attachment Inspection

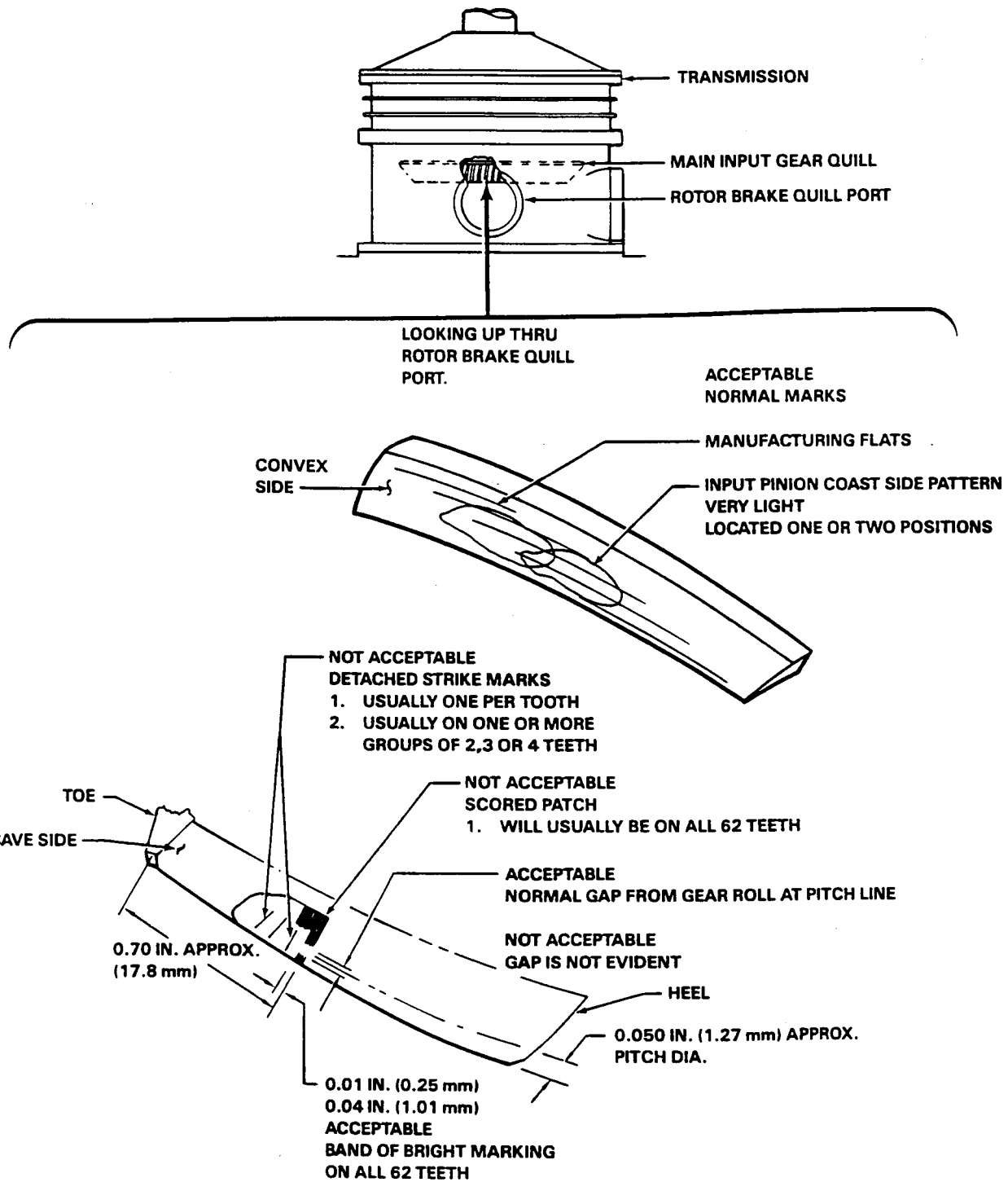

412-M-5-2-1

Figure 5-11. Spiral Bevel Gear Inspection (Sheet 1 of 3)

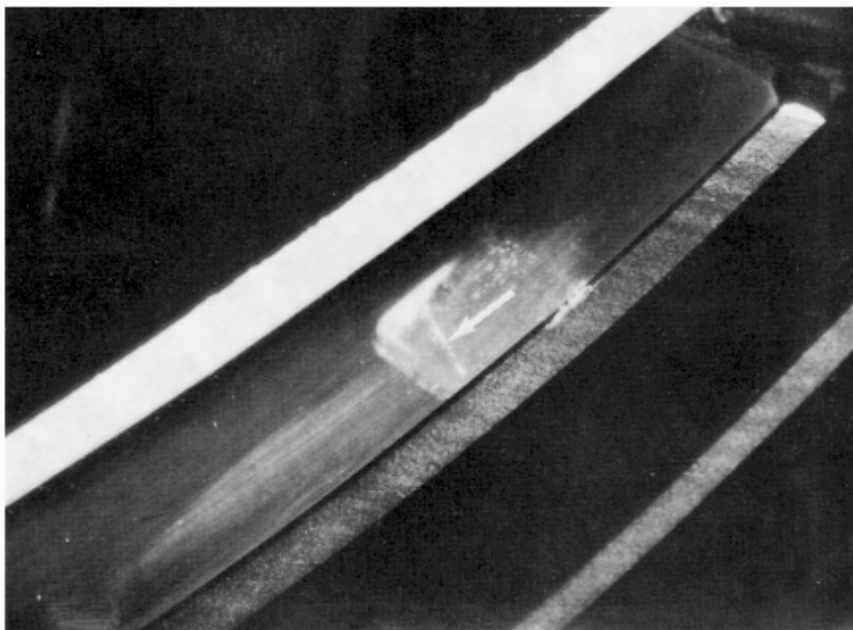

204-040-701 AND 412-040-701 SPIRAL BEVEL GEAR UNACCEPTABLE PATTERN

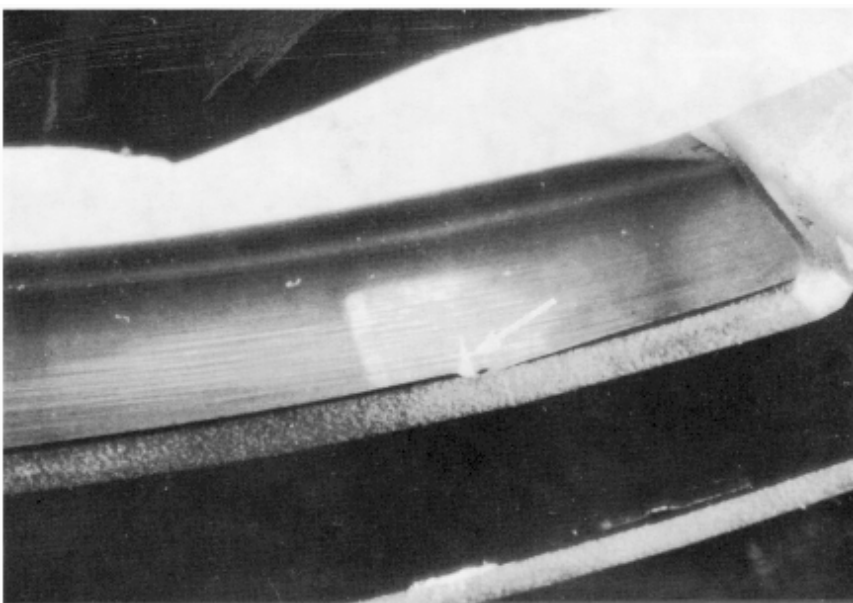

204-040-701 AND 412-040-701 SPIRAL BEVEL GEAR UNACCEPTABLE PATTERN

412-M-5-2-2

Figure 5-11. Spiral Bevel Gear Inspection (Sheet 2 of 3)



204-040-701 AND 412-040-701 SPIRAL BEVEL GEAR UNACCEPTABLE PATTERN

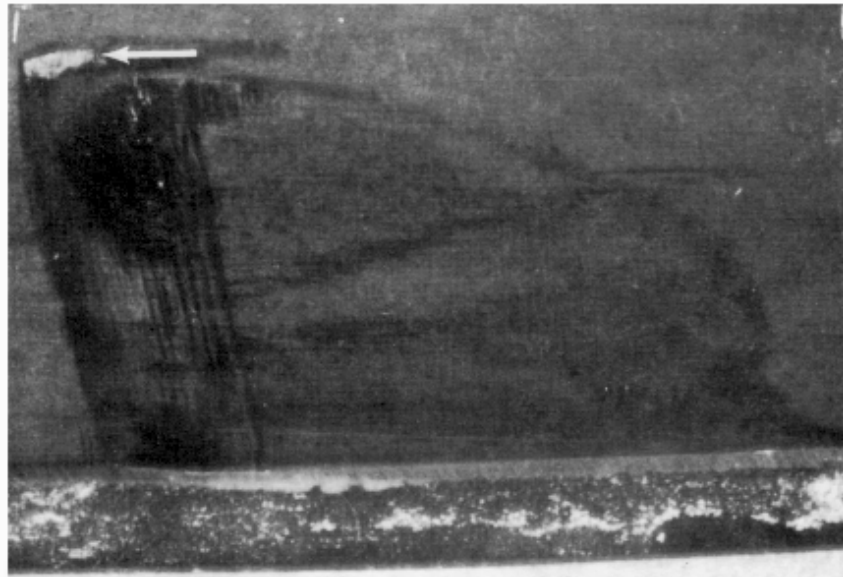

204-040-701 AND 412-040-701 SPIRAL BEVEL GEAR UNACCEPTABLE PATTERN

412-M-5-2-3

Figure 5-11. Spiral Bevel Gear Inspection (Sheet 3 of 3)



COMPONENT OVERHAUL SCHEDULE

5-52. COMPONENT OVERHAUL SCHEDULE

The Component Overhaul Schedule (Table 5-1) provides the time interval between overhaul for each applicable helicopter component.



OVERHAUL SCHEDULE FOR SOME KIT COMPONENTS AND/OR PARTS IS NOT COVERED IN THIS SCHEDULE. REFER TO APPLICABLE SERVICE INSTRUCTIONS FOR KIT COMPONENTS SCHEDULE.



DO NOT APPLY TOLERANCES TO PARTS WITH A LIMITED AIRWORTHINESS LIFE (CHAPTER 4).

NOTE

Refer to paragraph 5-1 for information on inspection and overhaul tolerance.



DO NOT EXCEED RETIREMENT LIFE FOR CRITICAL COMPONENTS. REFER TO AIRWORTHINESS LIMITATIONS SCHEDULE (CHAPTER 4).

NOTE

Neither assignment of a time period for overhaul of a component or failure to assign a time period for overhaul of a component constitutes a warranty of any kind. The only warranty applicable to helicopter and any component is that warranty included in the Purchase Agreement for the helicopter or component.

SOME PARTS INSTALLED AS ORIGINAL EQUIPMENT ON MILITARY HELICOPTERS MAY HAVE A LOWER AIRWORTHINESS LIFE AND/OR OVERHAUL SCHEDULE THAN WHEN USED ON A COMMERCIAL HELICOPTER. CONSEQUENTLY, PARTS THAT HAVE BEEN USED ON MILITARY HELICOPTERS SHOULD NOT BE USED ON COMMERCIAL HELICOPTERS.

The overhaul interval specified for any given part number contained in this Component Overhaul Schedule applies to all successive dash numbers (or suffixes) for that item unless otherwise specified.

Refer to the applicable Pratt & Whitney Canada Engine Maintenance Manual or Service Bulletin for engine and related component overhaul intervals.



Table 5-1. Component Overhaul Schedule















NOMENCLATURE	PART NUMBER 	OVERHAUL INTERVAL (HOURS)
ROTORS		
Swashplate and Support Assembly	412-010-402-101	2500 hours
Collective Lever Assembly	412-010-408-ALL	2500 hours
Collective Lever Assembly	412-010-464-101	2500 hours
Hub and Sleeve Assembly	412-010-401-105	2500 hours
Main Rotor Pitch Link Assembly	412-010-425-ALL	2500 hours
Main Rotor Hub Assembly	412-010-100 Series	
Tail Rotor Hub Assembly	212-011-701-003	 2500 hours
Main Rotor Blades	412-015-200 & -300 Series	
POWER TRAIN		
Rotor Brake Quill	412-040-123-101	3000 hours
Rotor Brake Quill	412-040-123-103	3000 hours
Rotor Brake Quill	412-540-014-101	 3000hours
Driveshaft Assembly	212-040-005-103	3000 hours
Driveshaft Assembly	412-040-005-101	3000 hours
Transmission	412-040-002-103	  6000 hours
Transmission	412-040-004-103	   6000 hours
Transmission	412-040-007-101	  6000 hours
Quill Assembly, Auxiliary Equipment	412-040-703-103	 1000 hours
Intermediate Gearbox Assembly	412-040-006-101	  5000 hours
Intermediate Gearbox Assembly	212-040-003-023	5000 hours



Table 5-1. Component Overhaul Schedule (Cont)







































NOMENCLATURE	PART NUMBER 	OVERHAUL INTERVAL (HOURS)
POWER TRAIN (CONT)		
Tail Rotor Gearbox Assembly	212-040-004-103	  5000 hours
Tail Rotor Gearbox Assembly	212-040-004-009	5000 hours
Tail Rotor Driveshaft Hangers	212-040-600-005	3000 hours
Tail Rotor Driveshaft Hangers	412-040-600-101	 5000 hours
Tail Rotor Driveshaft Coupling	412-040-601-101	 5000 hours
Mast Assembly	412-040-366-103/-105	   5000 hours
Mast Assembly	412-040-366-109	    5000 hours  
Mast Assembly	412-040-366-111/-113	   5000 hours  
Mast Assembly	412-040-366-125	  6000 hours
Mast Assembly	412-040-366-129	   6000 hours
HYDRAULIC		
Flight Control Hydraulic Cylinders (Cyclic and Collective)	212-076-005-101	2500 hours
POWER PLANT		
Engine Combining (Reduction) Gearbox	PT6T-3B	  3500 hours
Engine Combining (Reduction) Gearbox	PT6T-3BE	   4000 hours
Engine Combining (Reduction) Gearbox	PT6T-3D	   4000 hours
Engine Combining (Reduction) Gearbox	PT6T-3DE	   4000 hours
Engine Combining (Reduction) Gearbox	PT6T-3DF	   4000 hours



Table 5-1. Component Overhaul Schedule (Cont)



NOMENCLATURE	PART NUMBER 	OVERHAUL INTERVAL (HOURS)
POWER PLANT (CONT)		
Starter Generator	209-060-221-001	1000 hours
Starter Generator	200SG119Q	1000 hours
Fire Extinguisher Container	209-062-908-001	 5 years

Table 5-1. Component Overhaul Schedule (Cont)













NOTES:		
	Operating time specified for overhaul of any given part number in this schedule applies to all successive dash numbers (or suffixes), unless otherwise specified.	
	On condition. Special Inspection required each 2500 hours (paragraph 5-34 and paragraph 5-35).	
	The overhaul interval for engine combining (reduction) gearboxes modified in accordance with TB 412-89-80 is 4000 hours.	
	Special Inspection required each 2500 hours on helicopters S/N 36020 through 36999 and helicopters modified by 412-570-001-103 or Post BHT-412-SI-74 (412SP to 412HP Upgrade) (paragraph 5-36).	
	Refer to  .	
	All transmission quills, with the exception of rotor brake quill, shall be overhauled at time of transmission overhaul.	
	Incorporation of Increased Maximum Continuous Power Kit (BHT-412-SI-38) P/N 412-706-029-ALL reduces the time between overhaul (TBO) interval to 2500 hours.	
	Mast assembly 412-040-366-109 is not field serviceable. It must be returned to Bell Helicopter Textron for any maintenance requiring disassembly.	
	For each hoist operation performed within penalty CG region, 4 additional flight hours must be logged against main rotor mast, yoke, and lower cone seat. Refer to Chapter 4 for penalty region chart.	
	The following items are to be overhauled at the same time as the tail rotor hub assembly: Idler assembly 209-011-711-ALL Lever assembly 209-011-712-ALL Nut, tail rotor retention 212-010-706-ALL Crosshead 212-010-775-ALL Link assembly 209-011-713-ALL	
	Hydrostatic test in accordance with specification DOT-4 DA, DOT-4 DS700, or DOT-SP-7945, as marked on the reservoir, every 5 years or prior to refill after leakage or discharge. Extensions to this item are not permitted.	



Table 5-1. Component Overhaul Schedule (Cont)

NOTES: (CONT)

- [12](#) Refer to TB 412-03-191.
- [13](#) Special inspection required each 3000 hours on helicopters S/N 36020 through 36999, S/N 37002 through 37999 and helicopters modified by 412-570-001-103 or Post BHT-412-SI-74 (412SP to 412HP Upgrade) ([paragraph 5-40](#)).
- [14](#) Incorporation of Increased Maximum Continuous Power Kit (BHT-412-SI-38) P/N 412-706-029-ALL reduces the Time Between Overhaul (TBO) interval to 3000 hours.
- [15](#) Refer to BHT-412-SI-36 for maintenance information.
- [16](#) Visually inspect (BHT-412-CR&O) tube assembly 412-040-510-103 at mast assembly overhaul.
- [17](#) Special inspection required each 2500 hours on helicopters S/N 36020 through 36999, S/N 37002 through 37999 and helicopters modified by 412-570-001-103 or Post BHT-412-SI-74 (412SP to 412HP Upgrade) ([paragraph 5-37](#)).
- [18](#) Special inspection required each 3000 hours on helicopters prior to S/N 36020 and helicopters not modified by 412-570-001-103 or BHT-412-SI-74 (412SP to 412HP Upgrade) ([paragraph 5-39](#)).
- [19](#) Special inspection required each 3000 hours on helicopters prior to S/N 36020 and helicopters not modified by 412-570-001-103 or BHT-412-SI-74 (412SP to 412HP Upgrade) ([paragraph 5-38](#)).
- [20](#) Refer to Pratt & Whitney Canada PT6T-3D Series Maintenance Manual for instructions on 2500 hour clutch inspection requirements.
- [21](#) The inspection and overhaul tolerance permitted by Bell does not apply to power plant components. Contact Pratt & Whitney Canada for any deviation in maintenance requirements.
- [22](#) Special inspection required each 3000 hours on helicopters S/N 36020 through 36999, S/N 37002 through 37999 and helicopters modified by 412-570-001-103 or Post BHT-412-SI-74 (412SP to 412HP Upgrade) and Post TB 412-14-231 ([paragraph 5-36](#)).
- [23](#) If the intent of TB 412-14-231 has been accomplished, special inspection ([paragraph 5-36](#)) is required each 3000 hours on helicopters S/N 36020 through 36999, and helicopters modified by 412-570-001-103 or Post BHT-412-SI-74 (412SP to 412HP Upgrade).
- [24](#) If the intent of TB 412-14-231 has been accomplished, then the overhaul interval is 6000 hours.

